



JBM[®]

YOUR TOOLS

PRICES VALID FROM THE
01/04/2024



2024



TOOL SETS

7

TOOL SETS
SOCKET SETS
TOOL BOXES / CASES
BIT SETS
MINI RATCHET SET
SET OF ADAPTORS
SOCKETS SETS
BIT SOCKET SETS
INSULATED TOOLS



HAND TOOLS

37

SPANNERS
BAR CLAMP
RATCHET
TORQUE WRENCHES
EXTENSION BARS
SCREWDRIVERS
PLIERS
INSPECTION TOOLS
HAMMERS
CUTTING TOOLS
CHISELS
RIVETERS
MEASURING TOOLS
VARIOUS



WORKSHOP FURNITURE

71

TOOL TROLLEYS
TOOL SETS
ACCESSORIES FOR TROLLEY
WORK BENCHES
STORAGE
STOOLS / MECHANIC CREEPER
VICES/ANVILS



POWER TOOLS CORDLESS

101

SCREWDRIVING
DRILLING
SANDING/POLISHING
SAWING
SPECIAL TOOLS
GARDENING POWER TOOLS
BATTERIES / CHARGERS
ACCESORIES / CONSUMABLES



LIGHTING

129

INSPECTION LAMPS
HEAD TORCHES
LED MAGNIFYING LAMP
FLOOD LED
BONNET LIGHTING
BEACONS
LED WORK LAMP
SIGNALLING
ACCESSORIES AND SPARE PARTS



PNEUMATIC TOOLS

145

SCREWDRIVING
 DRILLING
 CUTTING / SAWING
 SANDING/POLISHING
 AIR BLOW GUNS
 TYRE MAINTENANCE
 OTHER
 AIR HOSE REEL
 CONNECTOR HOSES
 ACCESSORIES AND CONSUMABLES



IMPACT TOOLS

167

IMPACT SOCKETS
 SPECIAL TOOLS FOR TYRES
 ADAPTERS
 IMPACT SOCKETS SPARE PARTS
 SPECIAL TOOLS FOR TRUCKS



CAR BODY WORK

179

SHEET METAL WORK TOOLS
 HEADLIGHT RESTORATION
 GLASS REPLACEMENT
 CHASSIS REPAIR
 AUXILIARY FURNITURE
 INTERIOR MAINTENANCE



BRAKES

193

RETRACTOR TOOLS
 BRAKE BLEEDER
 MAINTENANCE



SPECIAL TOOLS

199

LUBRICATION SYSTEM
 INJECTOR PULLERS
 BLOCK/CYLINDER HEAD
 CLUTCH
 COOLING SYSTEM
 A/C SYSTEM
 TRANSMISSION
 SUSPENSION
 EXHAUST
 ELECTRICAL SYSTEM
 THREAD REPAIR
 MOTORCYCLE
 EXTRACTORS



TIMING TOOLS

243

FIAT/ALFA ROMEO
BMW/MINI
PSA
FORD
JAGUAR/LAND ROVER
JEEP/CHRYSLER

MERCEDES-BENZ
RENAULT/DACIA/NISSAN
OPEL/VAUXHALL
VAG
OTHERS
ADDITIONAL TOOLS



LUBRICANT ACCESSORIES

301

DIESEL FUEL SUPPLY PUMPS
 UREA SUPPLY PUMPS
 EXTRACTION/FILLING PUMPS
 OIL COLLECTORS
 SUCTION GUNS
 OIL COLLECTOR BUCKETS
 OTHERS



HYDRAULIC TOOLS

313

TROLLEY JACKS
BOTTLE JACKS
RATCHED JACKS
TELESCOPIC HYDRAULIC JACK
CAR JACK STANDS
OTHERS
MANUAL PALLET JACK
PRESSES
CRANES
LIFTING TABLES
RUBBER TAP FOR CAR LIFT



ELECTRIC TOOLS

327

JUMP STARTER
BATTERY MAINTENANCE
MILTIMETERS
VISUAL INSPECTION
WELDING
WORKSHOP EQUIPMENT
AIR CONDITIONING
THERMOMETERS
OTHERS



RENEWABLE ENERGY AND MOBILITY OF THE FUTURE

341

ELECTRIC CAR CHARGING CABLES
ELECTRIC CAR CHARGERS
POWER GENERATOR
INSULATED TOOLS



WORKSHOP ACCESSORIES

347

HOSE REELS
LADDERS
TROLLEYS AND PLATFORMS



VEHICLE ACCESSORIES

353

- SIGNALLING
- EMERGENCY KITS
- BULBS
- FIRST AID KITS
- SAFETY
- JOINT BOOT SETS AND CLAMPS
- MATS
- WIPERS
- BIKE
- OTHER
- PARKING SENSORS
- FLEXIBLE TUBES



TYRE ACCESSORIES

367

- WHEEL WEIGHTS
- PUNCTURE REPAIR
- TYRE VALVES
- REMOVAL AND INSTALLATION

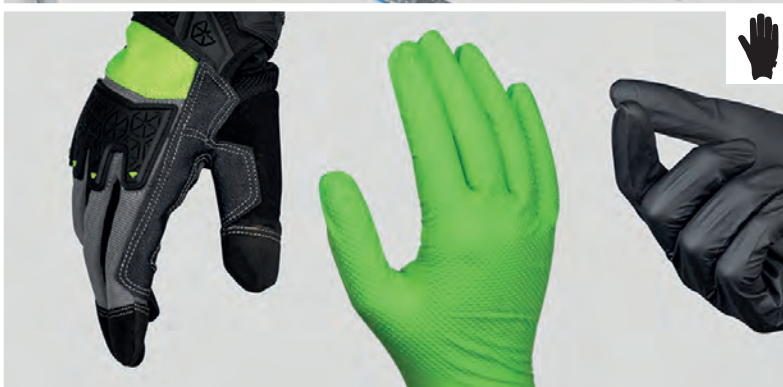

SAFETY AND PPE

373

- GLOVES / PPE
- MASKS / DISPENSERS
- DELIMITATION
- OZONE METER



CONSUMABLES

381

- PINS AND CIRCLIPS
- WASHERS
- SCREWS NUT WASHERS
- CRANKCASE AND ENGINE WASHERS
- OTHERS
- GASKETS AND O-RINGS
- HOSE CONNECTORS
- ELECTRICAL
- PLASTIC CLIPS AND STAPLES



WORK CLOTHING

405

- VEST
- JACKETS



PROMOTIONAL

407

- PROMOTIONAL PRODUCTS
- DISPLAYS / ACCESSORIES
- PACKAGING

JBM YOUR TOOLS

JBM is your brand for professional tools

Leading company specialised in the industry and automotive sector

+7.000

PRODUCTS
AVAILABLE

+23.000

EUROPALLETS
IN STOCK

+68

EXPORTING TO MORE
THAN 68 COUNTRIES

+550

NEW PRODUCTS
EVERY YEAR

MORE THAN 30 YEARS OF EXPERIENCE

At JBM we are specialists in the distribution of automotive tools and equipment, offering a close and quality service to our more than 11,000 customers in more than 68 countries.

DISTRIBUTION AND LOGISTICS EXPERTS

JBM has a constantly improving logistic network that allows a fast and efficient distribution not only in the Iberian Peninsula but also to all international customers.

WIDE RANGE OF PRODUCTS

We offer a complete range of more than 7,000 items in tool boxes, tool cases, all types of hand tools, tool cabinets, workshop tools, lighting, consumable cases...



**QUALITY SERVICE
BACKED BY MORE THAN
11.000 CUSTOMERS**

**INTERNATIONAL
DELIVERIES
WE EXPORT TO MORE
THAN 68 COUNTRIES**

**HEADQUARTERS IN SPAIN
AND WAREHOUSE OF
MORE THAN 6.000M²**



TOOL SETS

- 9 TOOL SETS
- 17 SOCKET SETS
- 24 TOOL BOXES / CASES
- 28 BIT SETS
- 32 MINI RATCHET SET
- 32 SET OF ADAPTORS
- 33 SOCKETS SETS
- 34 BIT SOCKET SETS
- 35 INSULATED TOOLS



HIGH QUALITY TOOLS FOR THE DAY-TO-DAY

01

DESIGNED FOR A
OPTIMAL PERFORMANCE
IN ALL KIND OF WORKS

02

RESISTANT MATERIAL
WITH CHROMED STEEL
FINISH OF OPTIMAL QUALITY

03

ERGONOMIC HANDLE
OF BIG DIAMETER FOR
A BETTER TORSION CAPACITY



54034

178,00€



216 PIECES HEX SOCKET AND RATCHET SPANNER SET - ZINC FINISH



ZINC FINISH

54045

179,00€



216 PIECES HEX SOCKET AND RATCHET SPANNER SET - CHROME FINISH



CHROME FINISH



IT CONTAINS

	1/2" x14	13, 14, 15, 16, 17, 18, 19, 20, 21, 22, 24, 27, 30, 32mm
	3/8" x10	10, 11, 12, 13, 14, 15, 16, 17, 18, 19mm
	1/4" x13	4, 4.5, 5, 5.5, 6, 7, 8, 9, 10, 11, 12, 13, 14mm
	1/2" x5	16, 17, 18, 19, 22mm
	3/8" x6	10, 11, 12, 13, 14, 15mm
	1/4" x7	4, 5, 6, 7, 8, 9, 10mm
	1/2" x3	E20, E22, E24
	3/8" x6	E10, E11, E12, E14, E16, E18
	1/4" x5	E4, E5, E6, E7, E8
	1/2" x3	1/2" - 3/8" - 1/4"
	1/2" x2	125, 250mm
	3/8" x1	125mm
	1/4" x2	50, 100mm
	x3	1/2" - 3/8" - 1/4"
	1/2" x1	converter 3/8" H x 1/2" M
	1/2" x1	8mm
	3/8" x1	8mm
	1/4" x1	6mm

	1/2" x2	16, 21mm
	3/8" x1	18mm
	1/2" x12	8, 9, 10, 11, 12, 13, 14, 15, 16, 17, 18, 19mm
	1/2" x7	1.27, 1.5, 2, 2.5, 3, 4, 5mm
	1/4" x1	
	1/4" x1	
	1/4" x1	
	1/2" x1	T70
	1/2" x1	14mm
	x3	PH0, PH1, PH2
	x3	P20, P21, P22
	x4	3, 4, 5, 6mm
	x4	SL4, SL5.5, SL6.5, SL7
	x8	T8, T9, T10, T15, T20, T25, T27, T30
	x8	T8, T9, T10, T15, T20, T25, T27, T30

	8mm x4	7, 8, 10, 12mm
	6mm x6	2, 2.5, 3, 4, 5, 6mm
	8mm x3	SL8, SL10, SL12
	8mm x3	PH2, PH3, PH4
	8mm x3	P22, P23, P24
	8mm x5	T40, T45, T50, T55, T60
	6mm x3	T5, T6, T7
	8mm x5	T40, T45, T50, T55, T60
	6mm x1	T7
	8mm x4	M10, M11, M12, M13
	6mm x5	M5, M6, M7, M8, M9
	8mm x2	M10, M12
	6mm x3	M5, M6, M8
	8mm x1	TS50
	6mm x8	TS10, TS15, TS20, TS25, TS27, TS30, TS40, TS45
	x4	0, 1, 2, 3mm
	x3	6, 8, 10mm
	6mm x4	4, 6, 8, 10mm
	x3	1, 2, 3mm
	x4	1, 2, 3, 4mm
	6mm x1	1/4"

54250

188,00€

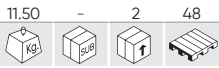

216 PIECES 12-POINT SOCKET AND RATCHET SPANNER SET - ZINC FINISH



ZINC FINISH



SPARE PARTS AVAILABLE



IT CONTAINS

	1/2" x14	13, 14, 15, 16, 17, 18, 19, 20, 21, 22, 24, 27, 30, 32mm
	3/8" x10	10, 11, 12, 13, 14, 15, 16, 17, 18, 19mm
	1/4" x13	4, 4.5, 5, 5.5, 6, 7, 8, 9, 10, 11, 12, 13, 14mm
	1/2" x5	16, 17, 18, 19, 22mm
	3/8" x6	10, 11, 12, 13, 14, 15mm
	1/4" x7	4, 5, 6, 7, 8, 9, 10mm
	1/2" x3	E20, E22, E24
	3/8" x6	E10, E11, E12, E14, E16, E18
	1/4" x5	E4, E5, E6, E7, E8
	1/2" x3	12
	1/2" x2	125, 250mm
	3/8" x1	125mm
	1/4" x2	50, 100mm
	1/2" x3	1/2" - 3/8" - 1/4"
	1/2" x1	converter 3/8" H x 1/2" M

	1/2" x1	8mm
	3/8" x1	8mm
	1/4" x1	6mm
	1/2" x2	16, 21mm
	3/8" x1	18mm
	1/2" x12	8, 9, 10, 11, 12, 13, 14, 15, 16, 17, 18, 19mm
	1/2" x7	1.27, 1.5, 2, 2.5, 3, 4, 5mm
	1/4" x1	
	1/4" x1	
	1/4" x1	
	1/2" x1	T70
	1/2" x1	14mm
	x3	PH0, PH1, PH2
	x3	PZ0, PZ1, PZ2
	x4	3, 4, 5, 6mm
	1/4" x4	SL4, SL5.5, SL6.5, SL7
	x8	T8, T9, T10, T15, T20, T25, T27, T30
	x8	T8, T9, T10, T15, T20, T25, T27, T30

	8mm x4	7, 8, 10, 12mm
	6mm x6	2, 2.5, 3, 4, 5, 6mm
	8mm x3	SL8, SL10, SL12
	8mm x3	PH2, PH3, PH4
	8mm x3	PZ2, PZ3, PZ4
	8mm x5	T40, T45, T50, T55, T60
	6mm x3	T5, T6, T7
	8mm x5	T40, T45, T50, T55, T60
	6mm x1	T7
	8mm x4	M10, M11, M12, M13
	6mm x5	M5, M6, M7, M8, M9
	8mm x2	M10, M12
	6mm x3	M5, M6, M8
	8mm x1	TS50
	6mm x8	TS10, TS15, TS20, TS25, TS27, TS30, TS40, TS45
	x4	0, 1, 2, 3mm
	x3	6, 8, 10mm
	6mm x4	4, 6, 8, 10mm
	x3	1, 2, 3mm
	x4	1, 2, 3, 4mm
	6mm x1	1/4"

54082

189,00€

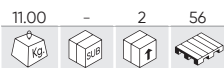

132 PIECES HEXAGONAL SOCKET TOOL SET - ZINC FINISH



ZINC FINISH



SPECIAL AUTOMOTIVE



IT CONTAINS

	1/2" x7 19, 21, 22, 24, 27, 30, 32mm
	3/8" x12 8, 9, 10, 11, 12, 13, 14, 15, 16, 17, 18, 19mm
	1/4" x11 4, 5, 5.5, 6, 7, 8, 9, 10, 11, 12, 13mm
	3/8" x4 13, 14, 15, 17mm
	1/4" x4 8, 10, 12, 13mm
	3/8" x6 E8, E10, E11, E14, E16, E20
	1/2" x1
	3/8" x1
	1/4" x1
	1/2" x2 127, 254mm
	3/8" x2 76, 152mm
	1/4" x1 50mm
	x1 Ø14mm
	x1

	x1 3/8"(H) - 1/2"(M)
	x1 3/8"(H) - 1/2"(M)
	x1 3/8"(H) - 1/2"(M)
	1/2" x1
	3/8" x1
	1/4" x1
	1/2" x3 17, 19, 21mm
	1/4" x1 6mm
	x1
	x1 PH2x100
	x1 SL6x100
	x12 8, 9, 10, 11, 12, 13, 14, 15, 16, 17, 18, 19mm
	x1
	1/2" x1 H17
	x1

	1/2" x1 21mm
	3/8" x2 16, 18mm
	1/2" x1 T52
	1/2" x1 M16
	x2 5.5, 6.5mm
	x2 PH1, PH3
	3/8" x2 PZ1, PZ3
	x4 4, 5, 6, 8mm
	x6 T20, T30, T40, T45, T50, T55
	x3 4, 5, 6.5mm
	x3 PH1, PH2, PH3
	6mm x3 PZ1, PZ2, PZ3
	x4 3, 4, 5, 6
	x7 T10, T15, T20, T25, T27, T30, T40
	x9 1.5, 2, 2.5, 3, 4, 5, 6, 8, 10mm

TOOL SETS

54035

149,00€

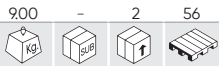

179 PIECES HEXAGONAL SOCKET SET - ZINC FINISH



ZINC FINISH

54046

150,00€

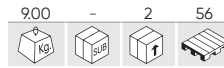

179 PIECES HEXAGONAL SOCKET SET - CHROME FINISH



CHROME FINISH



IT CONTAINS

	1/2" x17	10, 11, 12, 13, 14, 15, 16, 17, 18, 19, 20, 21, 22, 24, 27, 30, 32mm
	3/8" x10	10, 11, 12, 13, 14, 15, 16, 17, 18, 19mm
	1/4" x13	4, 4.5, 5, 5.5, 6, 7, 8, 9, 10, 11, 12, 13, 14mm
	1/2" x5	16, 17, 18, 19, 22mm
	3/8" x6	10, 11, 12, 13, 14, 15mm
	1/4" x7	4, 5, 6, 7, 8, 9, 10mm
	1/2" x2	E20, E24
	3/8" x6	E10, E11, E12, E14, E16, E18
	1/4" x5	E4, E5, E6, E7, E8
	1/2" x3	1/2" - 3/8" - 1/4"
	1/2" x2	125, 250mm
	3/8" x1	125mm
	1/4" x2	50, 100mm

	x3	1/2" - 3/8" - 1/4"
	1/2" x2	16, 21mm
	3/8" x1	18mm
	1/2" x1	8mm
	3/8" x1	8mm
	1/4" x1	6mm
	x7	1.27, 1.5, 2, 2.5, 3, 4, 5mm
	x1	1/4"
	x1	1/4"
	x3	PH1, PH2, PH3
	x3	PZ1, PZ2, PZ3
	1/4" x5	2, 3, 4, 5, 6mm
	x3	SL4, SL5.5, SL7
	x8	T8, T9, T10, T15, T20, T25, T27, T30
	x8	T8, T9, T10, T15, T20, T25, T27, T30

	x11	T5, T6, T7, T8, T9, T10, T15, T20, T25, T27, T30
	x9	T7, T10, T15, T20, T25, T27, T30, T40, T45
	x5	M5, M6, M7, M8, M9
	x3	M5, M6, M8
	x2	PH3, PH4
	x2	PZ3, PZ4
	x5	7, 8, 10, 12, 14mm
	x3	SL8, SL10, SL12
	x6	T40, T45, T50, T55, T60, T70
	x6	T40, T45, T50, T55, T60, T70

54036

99,00€

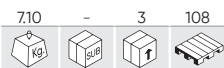

113 PIECES 12-POINT SOCKET SET ZINC FINISH



ZINC FINISH

54047

100,00€



113 PIECE 12-POINT SOCKET SET - CHROME FINISH



CHROME FINISH



IT CONTAINS

	1/2"	x17	10, 11, 12, 13, 14, 15, 16, 17, 18, 19, 20, 21, 22, 24, 27, 30, 32mm
	1/4"	x13	4, 4.5, 5, 5.5, 6, 7, 8, 9, 10, 11, 12, 13, 14mm
	1/2"	x5	14, 15, 17, 19, 22mm
	1/4"	x8	6, 7, 8, 9, 10, 11, 12, 13mm
	1/2"	x8	E10, E11, E12, E14, E16, E18, E20, E24
	1/4"	x5	E4, E5, E6, E7, E8
		x2	1/2" - 1/4"
	1/2"	x2	125, 250mm
	1/4"	x2	50, 100mm

		x2	1/2" - 1/4"
	1/2"	x1	converter 3/8" H x 1/2" M
	1/2"	x1	8mm
		x5	7, 8, 10, 12, 14mm
		x3	SL8, SL10, SL12
		x2	PH3, PH4
	8mm	x2	PZ3, PZ4
		x5	T40, T45, T50, T55, T60
		x5	5, 6, 8, 10, 12mm

	1/2"	x2	16, 21mm
		x3	1.5, 2, 2.5mm
		x1	1/4"
		x1	1/4"
		x2	PH1, PH2
		x2	PZ1, PZ2
	1/4"	x4	3, 4, 5, 6mm
		x3	SL4, SL5.5, SL6.5
		x7	T8, T10, T15, T20, T25, T27, T30

TOOL SETS

54037

88,00€

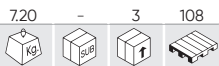

108 PIECES HEX SOCKET SET ZINC FINISH



ZINC FINISH

54048

89,00€

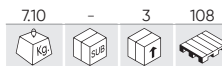

108 PIECES HEX SOCKET SET CHROME FINISH



CHROME FINISH



SPARE PARTS AVAILABLE



SPARE PARTS AVAILABLE

IT CONTAINS

	1/2" x17	10, 11, 12, 13, 14, 15, 16, 17, 18, 19, 20, 21, 22, 24, 27, 30, 32mm
	1/4" x13	4, 4.5, 5, 5.5, 6, 7, 8, 9, 10, 11, 12, 13, 14mm
	1/2" x5	14, 15, 17, 19, 22mm
	1/4" x8	6, 7, 8, 9, 10, 11, 12, 13mm
	1/2" x8	E10, E11, E12, E14, E16, E18, E20, E24
	1/4" x5	E4, E5, E6, E7, E8
	1/2" x2	1/2" - 1/4"
	1/2" x2	125, 250mm
	1/4" x2	50, 100mm
	1/2" x2	1/2" - 1/4"
	1/2" x1	converter 3/8" H x 1/2" M

	1/2" x2	16, 21mm
	1/2" x1	8mm
	x3	1.5, 2, 2.5mm
	x1	1/4"
	x1	1/4"
	x2	PH3, PH4
	x2	PZ3, PZ4
	8mm x5	7, 8, 10, 12, 14mm
	x3	SL8, SL10, SL12
	x5	T40, T45, T50, T55, T60

	x2	PH1, PH2
	x2	PZ1, PZ2
	1/4" x4	3, 4, 5, 6mm
	x3	SL4, SL5.5, SL6.5
	x7	T8, T10, T15, T20, T25, T27, T30

54038

88,00€

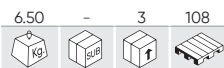

94 PIECES HEX SOCKET SET ZINC FINISH



ZINC FINISH

54049

89,00€



94 PIECES HEX SOCKET SET CHROME FINISH



CHROME FINISH



IT CONTAINS

	1/2"	x18	10, 11, 12, 13, 14, 15, 16, 17, 18, 19, 20, 21, 22, 23, 24, 27, 30, 32mm
	1/4"	x13	4, 4.5, 5, 5.5, 6, 7, 8, 9, 10, 11, 12, 13, 14mm
	1/2"	x4	14, 15, 17, 19mm
	1/4"	x8	6, 7, 8, 9, 10, 11, 12, 13mm
		x2	1/2" - 1/4"
	1/2"	x2	125, 250mm
	1/4"	x2	50, 100mm
		x2	1/2" - 1/4"
	1/2"	x1	converter 3/8" H x 1/2" M

	1/2"	x1	8mm
		x3	1.5, 2, 2.5mm
	1/2"	x2	16, 21mm
		x2	PH3, PH4
		x2	PZ3, PZ4
	8mm	x4	8, 10, 12, 14mm
		x3	SL8, SL10, SL12
		x4	T40, T45, T50, T55
	8mm	x1	1/4"

		x1	1/4"
		x1	1/4"
		x1	1/4"
		x2	PH1, PH2
		x2	PZ1, PZ2
	1/4"	x4	3, 4, 5, 6mm
		x3	SL4, SL5.5, SL7
		x6	T8, T10, T15, T20, T25, T30

53212

174,00€

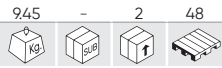

303 PIECES HEX SOCKET SET ZINC FINISH



ZINC FINISH



IT CONTAINS

	x18	10, 11, 12, 13, 14, 15, 16, 17, 18, 19, 20, 21, 22, 23, 24, 27, 30, 32mm
	x2	125, 250mm
	x2	16, 21mm
	x1	8mm
	x1	converter 3/8" H x 1/2" M
	x1	UNIVERSAL
	x1	72
	x13	4, 4.5, 5, 5.5, 6, 7, 8, 9, 10, 11, 12, 13, 14mm
	x2	50, 100mm
	x1	6,3mm
	x1	1/4"
	x1	UNIVERSAL
	x1	72
	x8	T25, T27, T30, T35, T40 (x2), T45, T50
	x2	PH3, PH4
	x2	PZ3, PZ4
	x4	H5.5, H6.5, H7, H8
	x4	5.5, 6.5, 7, 8mm
	x4	5, 6, 8, 10mm

	x9	3, 4, 4.5, 5, 5.5, 6, 6.5, 7, 8mm
	x9	T8, T10, T15, T20, T25, T27, T30, T35, T40
	x9	H1.5, H2, H2.5, H3, H.4, H5, H5.5, H6, H8
	x3	5, 6, 8mm
	x4	1, 2, 3, 4
	x3	6, 8, 10
	x3	C1, C2, C3
	x6	2, 2.5, 3, 4, 5, 6mm
	x4	S0, S1, S2, S3
	x6	5/64, 3/32, 7/64, 1/8, 9/64, 5/32
	x4	4, 6, 8, 10mm
	x10	PH0 (x2), PH1 (x2), PH2 (x4), PH3 (x2)
	x10	PZ0 (x2), PZ1 (x2), PZ2 (x4), Z3 (x2)
	x10	1/16, 5/64, 3/32, 7/64, 1/8, 9/64, 5/32, 3/16, 7/32, 1/4
	x10	T8, T10, T15, T20, T25, T27, T30, T35, T40, T45
	x6	1.5, 2, 2.5, 3, 3.5, 4mm
	x4	PH000, PH00, PH0, PH1
	x2	PZ0, PZ1
	x8	T5, T6, T7, T8, T9, T10, T15, T20

6.3x25
mmL

	x1		x1	300g
	x1		x1	
	x10		x1	
	x1		x23	
	x1	3m		x22
	x1			x10
	x1	8"		x10
	x2	0.4x2.5, 0.5x3.0x50mm		
	x3	PH0x50, PH00x50, PH000x50mm		
	x2	0.8x4x100, 1.2x6.5x125mm		
	x2	PH1x80, PH2x100mm		
	x7	1.27, 1.5, 2, 2.5, 3, 4, 5mm		
	x13	1.5, 2, 2.5, 3, 3.2, 3.5, 4, 4.5, 4.8, 5, 5.5, 6, 6.5mm		

54106

89,00€

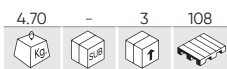

37-PIECE ZINC-FINISH INCH TOOL CASE



ZINC FINISH



SPARE PARTS AVAILABLE

IT CONTAINS

	1/2" x17	5/16", 3/8", 7/16", 1/2", 9/16", 19/32", 5/8", 11/16", 3/4", 13/16", 7/8", 15/16", 1", 1-1/16", 1-1/8", 1-3/16", 1-1/4"		1/2" x2	5" - 10"
	1/4" x8	3/16", 7/32", 1/4", 9/32", 5/16", 11/32", 3/8", 7/16"		1/4" x1	3"
	x2	1/2" - 1/4"		x1	1/2" - 1/4"
	1/2" x2	16, 21mm		x1	1/4"

53074

78,00€



74-PIECE TOOL CASE WITH 12-EDGED SOCKETS, ZINC FINISH



ZINC FINISH



SPARE PARTS AVAILABLE



IT CONTAINS

	1/2" x18	10, 11, 12, 13, 14, 15, 16, 17, 18, 19, 20, 21, 22, 23, 24, 27, 30, 32mm
	1/4" x10	4, 5, 5.5, 6, 7, 8, 10, 11, 12, 13mm
	x2	1/2" - 1/4"
	1/2" x2	125, 250mm
	1/4" x1	100mm
	x1	1/2"
	x5	PH0, PH1, PH2, PH3, PH4
	x5	PZ0, PZ1, PZ2, PZ3, PZ4
	x6	3, 4, 5, 6, 8, 10mm
	x5	SL3, SL4, SL5.5, SL6, SL7
	x8	T8, T10, T15, T20, T25, T27, T30, T40
	x4	4, 5, 6, 7mm
	1/2" x1	converter 3/8" H x 1/2" M
	1/2" x1	21mm
	x3	1.5, 2, 2.5mm
	x1	1/4"
	1/4" x1	6mm

54140

36,00€



56-PIECE TOOL KIT WITH 12-EDGED SOCKETS ZINC FINISH



ZINC FINISH



SPARE PARTS AVAILABLE



IT CONTAINS

	x13	4, 4.5, 5, 5.5, 6, 7, 8, 9, 10, 11, 12, 13, 14mm
	x1	T2
	x2	50, 100mm
	x1	1/4"
	x1	
	x1	
	x1	
	x1	
	x4	SL4, SL5, SL6, SL7
	x3	M5, M6, M8
	x8	T8, T10, T15, T20, T25, T27, T30, T40
	x8	T8, T10, T15, T20, T25, T27, T30, T40
	x3	PH0, PH1, PH2
	x3	PZ0, PZ1, PZ2
	x6	3, 4, 5, 6, 7, 8mm

TOOL SETS

54108

66,00€

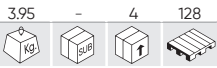

TOOL CASE 22 PCS. 1/2" HEXAGON SOCKETS ZINC FINISH

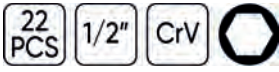

ZINC FINISH



IT CONTAINS

	1/2"	x17	10, 11, 12, 13, 14, 15, 16, 17, 18, 19, 20, 21, 22, 24, 27, 30, 32mm
	1/2"	x1	
	1/2"	x2	75, 125mm
		x1	3/8" (H) - 1/2" (M)
		x1	1/2"

54116

66,00€

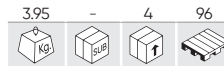

TOOL CASE 22 PCS. 12-EDGED SOCKETS 1/2" ZINC FINISH

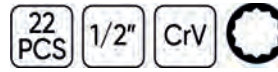

ZINC FINISH



IT CONTAINS

	1/2"	x17	10, 11, 12, 13, 14, 15, 16, 17, 18, 19, 21, 22, 24, 27, 30, 32mm
	1/2"	x1	1/2"
	1/2"	x2	125, 250mm
	1/2"	x1	
	1/2"	x1	3/8" (H) - 1/2" (M)

51818

109,00€

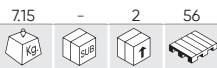

72 PIECES HEX SOCKET SET ZINC FINISH



ZINC FINISH



IT CONTAINS

	1/2"	x13	10, 11, 12, 13, 14, 15, 17, 19, 22, 24, 27, 30, 32mm
	1/4"	x10	4, 5, 6, 7, 8, 9, 10, 11, 12, 13mm
	1/4"	x5	5, 6, 7, 8, 9mm
	1/2"	x1	1/2"
	1/4"	x1	1/4"
	1/2"	x1	125mm
	1/4"	x1	75mm

	x1	
	x1	300gr
	x1	
	x1	
	x4	SL3, SL4, SL5, SL6
	x3	PH1, PH2, PH3
	x7	T10, T15, T20, T25, T27, T30, T40

	x2	1/2" - 1/4"
	x2	1/2" 16, 21mm
	x1	1/4" 6mm
	x8	10, 11, 12, 13, 14, 15, 17, 19mm
	x3	1.5, 2, 2.5mm
	x1	1/4"
	x2	PH2x100, PH1x40mm
	x3	8x200, 6x100, 6x40mm

54258

58,00€

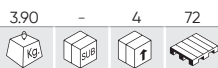

77 PIECES ZINC-FINISH TOOL CASE



ZINC FINISH



IT CONTAINS

	x5	PH0, PH1, PH2, PH2, PH3		x1
	x5	PZ0, PZ1, PZ2, PZ2, PZ3		x10
	x5	SL3, SL4, SL5, SL5.5, SL6mm		x1
	x5	T10, T15, T20, T25, T30		x1
	x4	6x7, 8x9, 10x11, 12x13mm		x1
	x9	1.5, 2, 2.5, 3, 4, 5, 6, 8, 10mm		x1
	x3	PH2x100, PH00x50, PH000x50		x1
	x3	SL6x100, SL2.5x50, SL3.0x50		x10
	x1			x10

54277

53,50€

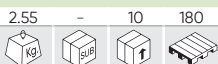

59 PIECE SOCKET SET WITH 3/8" HEXAGONAL SOCKETS - ZINC FINISH

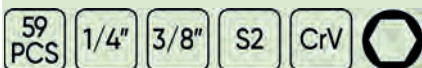

ZINC FINISH



SPARE PARTS AVAILABLE

IT CONTAINS

	3/8"	x17	6, 7, 8, 9, 10, 11, 12, 13, 14, 15, 16, 17, 18, 19, 20, 21, 22mm		x2	PH3, PH4		x2	PH1, PH2
	1/4"	x1	3/8"		x2	PZ3, PZ4		x2	PZ1, PZ2
	3/8"	x2	75, 150mm		x5	7, 8, 10, 12, 14mm		x4	3, 4, 5, 6mm
	3/8"	x1	8mm		x3	SL8, SL10, SL12		x3	SL4, SL5.5, SL6.5
	3/8"	x1	8mm		x5	T40, T45, T50, T55, T60		x7	T8, T10, T15, T20, T25, T27, T30
	3/8"	x1	3/8"						
	1/4"	x1	1/4"						

53953

29,00€

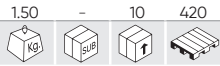

130 PCS. SOCKET AND BIT SET ZINC FINISH

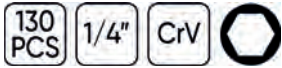

ZINC FINISH



IN 10 UNITS DISPLAY CASE

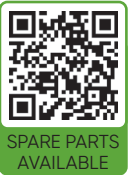

SPARE PARTS AVAILABLE

IT CONTAINS

	1/4"	x13	4, 4.5, 5, 5.5, 6, 7, 8, 9, 10, 11, 12, 13, 14mm
	1/4"	x1	1/4"
	1/4"	x1	50mm
	1/4"	x1	1/4"
	1/4"	x1	6mm
	1/4"	x1	1/4"
	1/4"	x1	1/4"
	1/4"	x7	1.27, 1.5, 2, 2.5, 3, 4, 5mm

	25mm	x10	T8, T10, T15, T20, T25, T27, T30, T35, T40, T45
	25mm	x9	T8, T10, T15, T20, T25, T27, T30, T35, T40
	25mm	x3	M5, M6, M8
	25mm	x3	6, 8, 10mm
	25mm	x3	C1, C2, C3
	25mm	x4	1, 2, 3, 4mm
	25mm	x4	4, 6, 8, 10mm
	25mm	x4	0, 1, 2, 3mm

	25mm	x10	1/16, 5/64, 3/32, 7/64, 1/8, 9/64, 5/32, 3/16, 7/32, 1/4
	25mm	x9	1.5, 2, 2.5, 3, 4, 5, 5.5, 6, 8mm
	25mm	x6	5/64, 3/32, 7/64, 1/8, 9/64, 5/32
	25mm	x6	2, 2.5, 3, 4, 5, 6mm
	25mm	x9	3, 4, 4.5, 5, 5.5, 6, 6.5, 7, 8mm
	50mm	x2	4, 6mm
	25mm	x10	PH0(x2), PH1(x2), PH2(x4), PH3(x2)
	50mm	x2	PH1, PH2
	25mm	x10	P20(x2), PZ1(x2), PZ2(x4), PZ3(x2)

54109

34,00€

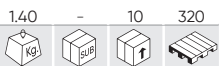

SET OF 46 PIECES WITH HEXAGONAL SOCKETS ZINC FINISH



ZINC FINISH



SPARE PARTS AVAILABLE



IT CONTAINS

	1/4"	x13	4, 4.5, 5, 5.5, 6, 7, 8, 9, 10, 11, 12, 13, 14mm
	1/4"	x1	
	1/4"	x1	
	1/4"	x1	
	1/4"	x2	50, 100mm
		x4	1.27, 1.5, 2.0, 2.5mm
		x1	
		x1	UNIVERSAL
		x1	1/4"
		x3	SL4, SL5.5, SL7
		x3	PH1, PH2, PH3
		x3	PZ1, PZ2, PZ3
		x6	H3, H4, H5, H6, H7, H8
		x6	T10, T15, T20, T25, T30, T40

54168

49,00€

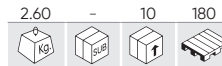

59-PIECE 3/8" TOOL KIT WITH 12-EDGE SOCKETS ZINC FINISH

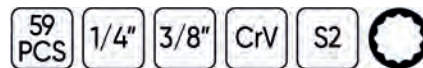

ZINC FINISH



SPARE PARTS AVAILABLE



IT CONTAINS

		x2	PH3, PH4
		x2	PZ3, PZ4
	8mm	x5	7, 8, 10, 12, 14mm
		x3	8, 10, 12mm
		x5	T40, T45, T50, T55, T60
		x2	PH1, PH2
		x2	PZ1, PZ2
	1/4"	x4	3, 4, 5, 6mm
		x3	4, 5.5, 6.5mm
		x7	T8, T10, T15, T20, T25, T27, T30
	3/8"	x17	6, 7, 8, 9, 10, 11, 12, 13, 14, 15, 16, 17, 18, 19, 20, 21, 22mm
	3/8"	x1	3/8"
	3/8"	x2	75, 150mm
	3/8"	x1	8mm
	3/8"	x1	8mm
	3/8"	x1	
	1/4"	x1	

54105 33,00€

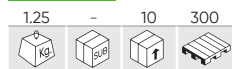

59-PIECE 3/8" TOOL KIT WITH 12-EDGE SOCKETS ZINC FINISH



ZINC FINISH



IT CONTAINS

	1/4"	x13	4, 4.5, 5, 5.5, 6, 7, 8, 9, 10, 11, 12, 13, 14mm
	1/4"	x1	
	1/4"	x2	50, 100mm
	1/4"	x1	
	1/4"	x1	
	1/4"	x1	
	1/4"	x1	6mm
	+	x3	PH0, PH1, PH2
	6mm	x3	PZ0, PZ1, PZ2
		x6	3, 4, 5, 6, 7, 8mm
		x4	SL4, SL5, SL6, SL7
		x3	M5, M6, M8
	6mm	x8	T8, T10, T15, T20, T25, T27, T30, T40
		x8	T8, T10, T15, T20, T25, T27, T30, T40
	6mm	x1	1/4"

52418 179,00€



39 PIECES GO-THROUGH SOCKET SET - CHROME FINISH



CHROME FINISH

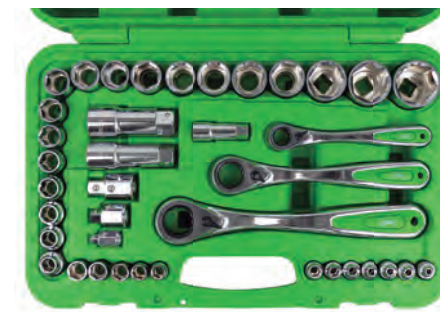

IT CONTAINS

	13mm	x12	4, 4.5, 5, 5.5, 6, 7, 8, 9, 10, 11, 12, 13mm
	19mm	x10	10, 11, 12, 13, 14, 15, 16, 17, 18, 19mm
	22mm	x5	20, 21, 22, 23, 24mm
	22mm	x3	27, 30, 32mm
	1/2"	x3	13, 19, 22mm
	17	x3	13, 19, 22mm
	1/4"	x1	13mm
	3/8"	x1	19mm
	1/2"	x1	22mm

54090 56,00€



14-PIECE GO-THROUGH TOOL KIT ZINC FINISH

ZINC FINISH



IT CONTAINS

	x11	13, 14, 15, 16, 17, 18, 19, 21, 22, 24, 27mm
	x1 (75mmL)	12,5mm
	x1	1/2"
	x1 (go-through)	17

50623 60,00€



17 PIECES GO-THROUGH SOCKET SET - CHROME FINISH

CHROME FINISH



IT CONTAINS

	x13	4, 4.5, 5, 5.5, 6, 7, 8, 9, 10, 11, 12, 13, 14mm
	x1	75mm
	x1	1/4"
	x1	145mm

TOOL SETS

52722

87,00€

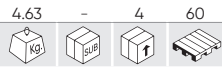

61-PIECE TOOL CASE 1/2" AND 1/4" SPLINE SOCKETS ZINC FINISH

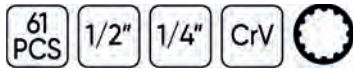

ZINC FINISH



53108

92,00€

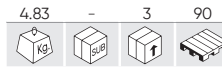

61 PIECES 1/4" & 1/2" 12-POINT SPLINE SOCKET SET CHROME FINISH



CHROME FINISH



IT CONTAINS

	1/2" x11	14, 15, 16, 17, 18, 19, 22, 24, 27, 30, 32mm
	1/4" x12	4, 4.5, 5, 5.5, 6, 7, 8, 9, 10, 11, 12, 13mm
	x2	1/2" - 1/4"
	x2	5" - 10"
	x2	2" - 4"
	x2	1/2" - 1/4"

	x1	converter 3/8" H x 1/2" M
	1/2" x2	16, 21mm
	x1	25mm
	x3	1.5, 2, 2.5mm
	x1	1/4"
	x1	1/4"
	x1	AD

	x3	PH1, PH2, PH3
	x3	PZ1, PZ2, PZ3
	25mm x5	3, 4, 5, 6, 8mm
	x3	SL4, SL5.5, SL7
	x5	T10, T15, T20, T25, T30

53915

65,00€

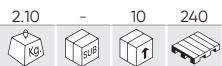

SET OF 6 SOCKETS 1/2" TORX TYPE E EXTRA LONG ZINC FINISH

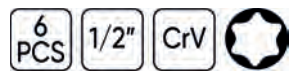

ZINC FINISH



IT CONTAINS

	1/2" x6	E10, E12, E14, E16, E18, E20
--	---------	------------------------------

E12 Socket for BMW cylinder head:
 - M42 engine, 1.8L, 4 cylinders, 16V, model 318 is from 1989
 - M50 engine, 2.0L, 2.5L, 6 cylinders, 24V, model 520i, 525i from 1991

54141

42,00€

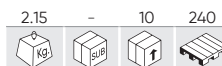

SET 28 SHORT AND LONG TORX SOCKETS ZINC FINISH

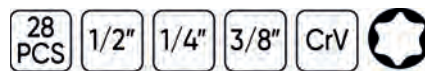

ZINC FINISH



IT CONTAINS

	1/4" x5 (25mm)	E4, E5, E6, E7, E8
	3/8" x5 (28mm)	E10, E11, E12, E14, E16
	1/2" x4 (38mm)	E18, E20, E22, E24
	1/4" x5 (50mm)	E4, E5, E6, E7, E8
	3/8" x5 (63mm)	E10, E11, E12, E14, E16
	1/2" x4 (76mm)	E18, E20, E22, E24





51616 378,00€

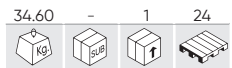

METAL CASE WITH 22 PIECES OF 1" ZINC-FINISH HEXAGON AUTOCLAVE

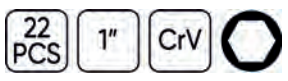

ZINC FINISH



METALLIC BOX
IT CONTAINS

	1"	x17	36, 38, 41, 46, 50, 54, 55, 58, 60, 63, 65, 67, 70, 71, 75, 77, 80mm
	1"	x1	650mm
	1"	x2	205, 410mm
	1"	x1	
	1"	x1	



51855 378,00€



METAL CASE WITH 22 PIECES OF 1" AUTOCLAVE ON 12 ZINC-FINISH EDGES

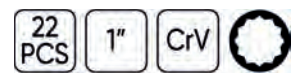

ZINC FINISH



METALLIC BOX
IT CONTAINS

	1"	x17	36, 38, 41, 46, 50, 54, 55, 58, 60, 63, 65, 67, 70, 71, 75, 77, 80mm
	1"	x1	650mm
	1"	x2	205, 410mm
	1"	x1	
	1"	x1	



53727 198,00€

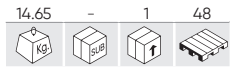

TOOL CASE WITH 21 PIECES 3/4" HEXAGON SOCKET ZINC FINISH

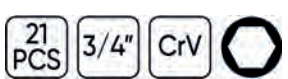

ZINC FINISH



IT CONTAINS

	3/4"	x16	19, 21, 22, 23, 24, 26, 27, 29, 30, 32, 35, 36, 38, 41, 46, 50mm
	3/4"	x1	495mm
	3/4"	x3	100, 200, 400mm
	3/4"	x1	445mm



53728 198,00€

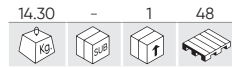

TOOL CASE WITH 21 PCS. 3/4" 12-EDGES ZINC FINISH

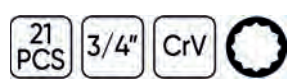

ZINC FINISH



IT CONTAINS

	3/4"	x16	19, 21, 22, 23, 24, 26, 27, 29, 30, 32, 35, 36, 38, 41, 46, 50mm
	3/4"	x1	495mm
	3/4"	x3	100, 200, 400mm
	3/4"	x1	445mm



TOOL SETS

54261



321,00€



N

METAL BOX WITH TOOLS 143 PIECES ZINC FINISH



ZINC FINISH



IT CONTAINS

	x13	4, 4.5, 5, 5.5, 6, 7, 8, 9, 10, 11, 12, 13, 14mm		x20	8, 9, 10, 11, 12, 13, 14, 15, 16, 17, 18, 19, 20, 21, 22, 23, 24, 27, 30, 32mm		x4	SL5x75, SL6x100, SL8x150, SL10x200mmL		
	x6	8, 10, 11, 12, 13, 14mm		x2	5" - 10"		x3	PH1x80, PH2x100, PH3x150mmL		
	x7	E4, E5, E6, E7, E8, E10, E11		x2	1/2"	x2	16, 21mm		x4	PH1, PH2x2, PH3
	x2	2", 4"		x1	UNIVERSAL		x4	PZ1, PZ2x2, PZ3		
	x1	110mmL		x1	3/8"(F) - 1/2"(M)		x4	SL3, SL4, SL5, SL6		
	1/4"	x1		x1	150L		x4	H3, H4, H5, H6		
	x3	PH1,PH2,PH3		x3	SL4,SL5.5,SL6.5		x7	T10, T15, T20, T25, T27, T30, T40		
	x6	TT10,TT15,TT20,TT25,TT30,TT40		x6	H3,H4,H5,H6,H7,H8		x7	TT10,TT15,TT20,TT25,TT27,TT30,TT40		
	x6	H3,H4,H5,H6,H7,H8		x3	SL4,SL5.5,SL6.5		x1	1/4"		
	x1	250mm		x6	TT10,TT15,TT20,TT25,TT30,TT40		x1	6.35mmx60mmL		
	x1	250mm		x6	H3,H4,H5,H6,H7,H8		x1	1/4"-6.35mm		
	x1	250mm		x1	7"-180mm		x1	7"-180mm		
	x1	250mm		x1	8"-200mm		x1	10"-250mm		

53565



258,00€



IRON TOOL BOX 64 PIECES ZINC FINISH



ZINC FINISH

IT CONTAINS

	1/2"	x18	10, 11, 12, 13, 14, 15, 16, 17, 18, 19, 20, 21, 22, 23, 24, 27, 30, 32mm		
	x1	1/2"			
	x1	1/2"			
	1/2"	x3	76, 127, 254mm		
	1/2"	x1	255mm		
	1/2"	x1	21mm		
	x1	457mm			
	x18	6, 7, 8, 9, 10, 11, 12, 13, 14, 15, 16, 17, 18, 19, 20, 21, 22, 24mm			
	x9	1.5, 2, 2.5, 3, 4, 5, 6, 8, 10mm			
	x3	PH1x100, PH2x150, H3x200mm			
	x3	SL5x100, SL6x150, SL8x200mm			
	x1	250mm		x1	180mm
	x1	200mm		x1	180mm



53159

289,00€

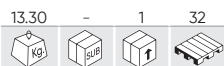

ALUMINIUM TOOL CASE 159 PIECES ZINC FINISH



ZINC FINISH



IT CONTAINS



	1/2" x14	14, 15, 16, 17, 18, 19, 20, 21, 22, 23, 24, 27, 30, 32mm
	1/4" x10	4, 5, 6, 7, 8, 9, 10, 11, 12, 13mm
	x2	1/4" - 1/2"
	1/2" x2	50, 100mm
	1/4" x2	125, 250mm
	1/4" x1	150mm
	x2	1/4" - 1/2"
	1/2" x1	converter 3/8" H x 1/2" M
	x2	1/4" - 1/2"
	1/4" x1	250mm
	1/4" x1	110mm
	1/2" x2	16, 21mm
	x1	1/4"

	x9	8, 10, 11, 12, 13, 15, 17, 19, 22mm
	x9	1.5, 2, 2.5, 3, 4, 5, 6, 8, 10mm
	x1	100-250V
	x1	
	x2	PH1x80, PH2x10mm
	x4	SL3x75, SL4x100, SL6.5x125, SL8x150mm
	x1	PH00x50mm
	x1	SL2.5x50mm
	x1	250mm
	x1	200mm
	x1	160mm
	x1	7" (180mm)
	x1	180mm
	x1	220mm
	x1	160mm
	x1	160mm

	x1	
	x6	1,5mm
	x1	
	x1	300gr
	x1	3m
	x1	200mm
	x5	
	x1	18mm
	x10	
	x40	6.35mm
	x15	8mm



53928

278,00€

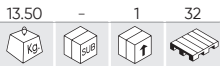

135-PIECE TOOL CASE WITH ZINC FINISH HEXAGON SOCKETS



ZINC FINISH



IT CONTAINS



	x10	10, 11, 12, 13, 14, 15, 17, 19, 22, 24mm
	x2	16, 21mm
	x1	UNIVERSAL
	x2	125, 250mm
	x1	3/8" - 1/2"
	x9	4, 5, 6, 7, 8, 9, 10, 11, 12mm
	x1	UNIVERSAL
	x1	1/4"
	x2	50, 100mm
	x1	6mm
	x9	8, 10, 11, 12, 13, 14, 17, 19, 22mm
	x1	150mm
	x1	



	x4	PH1, PH2, PH2, PH3
	x4	PZ1, PZ2, PZ2, PZ3
	x4	SL3, SL4, SL5, SL6
	x4	H3, H4, H5, H6
	x7	TT10, TT15, TT20, TT25, TT27, TT30, TT40
	x7	TT10, TT15, TT20, TT25, TT27, TT30, TT40
	x1	6mm
	x1	6mmL
	x5	
	x1	
	x2	PH1x80mm, PH2x100mm
	x4	SL3.0x75mm, SL4.0x100mm, SL6.5x125mm, SL8x150mm



	x1	
	x1	
	x3	SL1.5, SL2, SL3
	x4	PH000, PH00, PH0, PH1
	x8	T4, T5, T6, T7, T8, T10, T15, T20
	x4	TS0.8, TS1.2, TS1.5, TS2.0
	x1	H2.0
	x1	
	x1	
	x9	1.5, 2, 2.5, 3, 4, 5, 6, 8, 10mm
	x1	
	x1	5m
	x1	300g



	x1	250mm
	x1	180mm
	x1	180mm
	x1	200mm
	x1	160mm
	x1	200mm
	x1	
	x3	
	x1	18mm

53444

195,00€

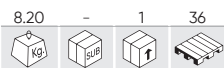

ALUMINIUM TOOL CASE 108 PCS. SOCKETS 1/2" ZINC FINISH

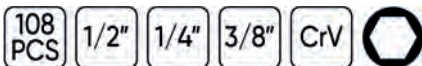

ZINC FINISH



IT CONTAINS



	x9	10, 11, 12, 13, 14, 15, 17, 18, 19mm
	x2	75, 150mm
	x1	1/2" 16mm
	x1	Ⓢ
	x1	converter 3/8" H x 1/2" M
	x8	4, 4.5, 5, 5.5, 6, 7, 8, 9mm
	x1	1/4" 150mmL
	x1	6mm
	x2	PH1x80, PH2x100mm
	x4	SL3.5x75, SL4x100, SL6.5x125, SL8x150mm
	x1	PH00x50mm
	x1	SL2.5x50mm
	x1	

	x9	6x7, 8x9, 10x11, 12x13, 14x15, 16x17, 18x19, 20x22mm
	x9	1.5, 2, 2.5, 3, 4, 5, 6, 8, 10mm
	x1	
	x6	
	x1	200mm
	x1	18mm
	x10	
	x1	220mm
	x1	180mm
	x1	160mm
	x1	250mm
	x1	160mm

	x30	
	x1	
	x1	300g
	x1	3m



52603

74,00€

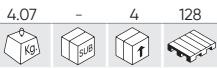

26 PIECES BIT SOCKET SET 12-POINT



IT CONTAINS

	x8 (55mmL)	M5, M6, M8, M9, M10, M12, M14, M16
	x7 (100mmL)	M5, M6, M8, M9, M10, M12, M14
	x7 (140mmL)	M5, M6, M8, M9, M10, M12, M14
	x4 (200mmL)	M8, M10, M12, M14

52606

88,00€



32 PIECES BIT SOCKET SET RIBE

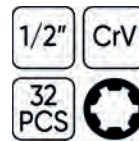

IT CONTAINS

	x9 (55mmL)	M5, M6, M7, M8, M9, M10, M12, M13, M14
	x9 (100mmL)	M5, M6, M7, M8, M9, M10, M12, M13, M14
	x7 (140mmL)	M7, M8, M9, M10, M12, M13, M14
	x7 (200mmL)	M7, M8, M9, M10, M12, M13, M14

52604

78,00€

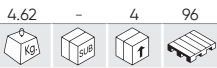

30 PIECES HEXAGONAL BIT SOCKET SET



IT CONTAINS

	x9 (55mmL)	5, 6, 7, 8, 10, 12, 14, 17, 19mm
	x8 (100mmL)	5, 6, 7, 8, 10, 11, 12, 13mm
	x7 (140mmL)	5, 6, 7, 8, 10, 12, 14mm
	x6 (200mmL)	5, 6, 7, 8, 10, 12mm

52605

76,00€



32 PIECES BIT SOCKET SET FOR TORX CREWS

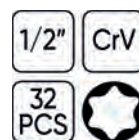

IT CONTAINS

	x10 (55mmL)	T20, T25, T27, T30, T40, T45, T50, T55, T60, T70
	x10 (100mmL)	T20, T25, T27, T30, T40, T45, T50, T55, T60, T70
	x6 (140mmL)	T40, T45, T50, T55, T60, T70
	x6 (200mmL)	T40, T45, T50, T55, T60, T70



54266

39,50€

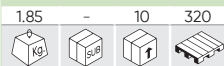

N

1/2" TORX SOCKET AND SOCKET BIT CASE 19 PIECES



IT CONTAINS

	x9	E10, E11, E12, E14, E16, E18, E20
	x10	T20, T25, T27, T30, T40, T45, T50, T55, T60, T70



SPARE PARTS AVAILABLE

54154

37,50€



12 PIECES BIT SOCKET SET 1/2" TORX

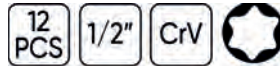

IT CONTAINS

	x6	T20, T25, T30, T40, T45, T50
	x6	T55, 60, T70, T80, T90, T100



SPARE PARTS AVAILABLE

51260

37,00€



SET OF 12 1/2" PIECES - HEXAGONAL BIT SOCKETS

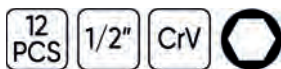

IT CONTAINS

	x6	H5, H6, H7, H8, H10, H12
	x1	H14
	x5	H16, H17, H18, H19, H20



SPARE PARTS AVAILABLE

54164

34,00€



SET OF 12 1/2" PIECES - 12-POINT BIT SOCKETS

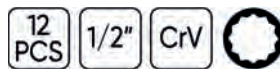

IT CONTAINS

	x6 (55mmL)	M4, M5, M6, M8, M9
	x6 (70mmL)	M10, M12, M14, M16, M18, M20



SPARE PARTS AVAILABLE



TOOL SETS

50983

48,00€



42 PIECES MECHANICS BIT SET HEX, 12-POINT, TORX AND RIBE

42 PCS 1/2"
3/8" S-2



IT CONTAINS

	3/8"	x1	10mm
	1/2"	x1	10mm
	30mm	x7	4, 5, 6, 7, 8, 10, 12mm
	75mm	x7	4, 5, 6, 7, 8, 10, 12mm
	30mm	x8	T20, T25, T30, T40, T45, T50, T55, T60
	75mm	x8	T20, T25, T30, T40, T45, T50, T55, T60
	30mm	x5	M5, M6, M8, M10, M12
	75mm	x5	M5, M6, M8, M10, M12



50985

59,00€



CASE WITH 42 PIECES FOR HEX, 12-POINT, TORX, AND RIBE (TAMPER-PROOF)

42 PCS 1/2"
3/8" S-2



IT CONTAINS

	3/8"	x1	10mm
	1/2"	x1	10mm
	30mm	x7	4, 5, 6, 7, 8, 10, 12mm
	75mm	x7	4, 5, 6, 7, 8, 10, 12mm
	30mm	x8	T20, T25, T30, T40, T45, T50, T55, T60
	75mm	x8	T20, T25, T30, T40, T45, T50, T55, T60
	30mm	x5	M5, M6, M8, M10, M12
	75mm	x5	M5, M6, M8, M10, M12



52550

92,00€

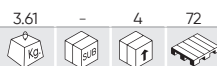

75 PIECES MECHANICS BIT SET HEXAGONAL, XZN, RIBE, TORX AND TORX TAMPER-PROOF

75 PCS 1/2"
3/8" S-2

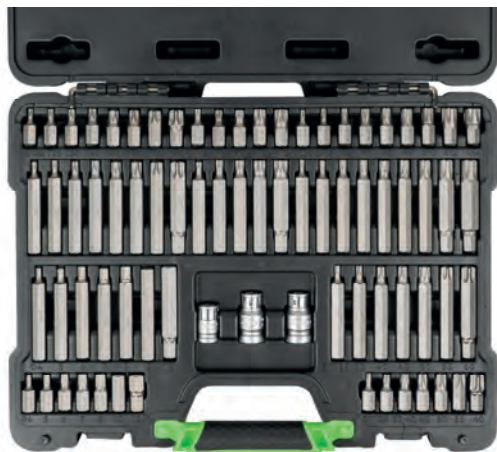

IT CONTAINS

	3/8"	x1	10mm
	1/2"	x2	10mm
	30mm	x7	4, 5, 6, 7, 8, 10, 12mm
	75mm	x7	4, 5, 6, 7, 8, 10, 12mm
	30mm	x8	T20, T25, T30, T40, T45, T50, T55, T60
	75mm	x8	T20, T25, T30, T40, T45, T50, T55, T60
	30mm	x5	M5, M6, M8, M10, M12
	75mm	x5	M5, M6, M8, M10, M12
	30mm	x8	R5, R6, R7, R8, R9, R10, R12, R14
	75mm	x8	R5, R6, R7, R8, R9, R10, R12, R14
	30mm	x8	TT20, TT25, TT30, TT40, TT45, TT50, TT55, TT60
	75mm	x8	TT20, TT25, TT30, TT40, TT45, TT50, TT55, TT60

52753

107,00€



55 PIECES MECHANICS BIT SET - HEAVY DUTY

55 PCS 1/2"
3/8" S-2



IT CONTAINS

	3/8"	x1	10mm
	1/2"	x2	10, 14mm
	30mm	x9	4, 5, 6, 7, 8, 10, 12, 14, 16mm - ISO 2136
	75mm	x9	4, 5, 6, 7, 8, 10, 12, 14, 16mm - ISO 2136
	30mm	x10	T20, T25, T30, T40, T45, T50, T55, T60, T70, T80 - DIN 2325
	75mm	x10	T20, T25, T30, T40, T45, T50, T55, T60, T70, T80 - DIN 2325
	30mm	x7	M5, M6, M8, M10, M12, M14, M16 - DIN 2325
	75mm	x7	M5, M6, M8, M10, M12, M14, M16 - DIN 2325

52539

59,00€

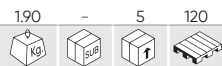

85 PIECES SCREWDRIVER BIT SET



IT CONTAINS

	x10	PH3, PH4
	x10	PZ3, PZ4
	x25	7, 8, 10, 12, 14mm
	x15	SL8, SL10, SL12
	x25	T40, T45, T50, T55, T60



52538

62,00€



90 PIECES SCREWDRIVER BIT SOCKET SET



IT CONTAINS

	x10	PH1, PH2
	x10	PZ1, PZ2
	x20	3, 4, 5, 6mm
	x15	SL4, SL5.5, SL6.5
	x35	T8, T10, T15, T20, T25, T27, T30



53574

47,00€

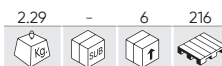

208 PIECES BIT SET



IT CONTAINS

	x12	1.5, 2, 2.5, 3, 3.5, 4, 4.5, 5, 5.5, 6, 7, 8mm
	x10	1/16, 5/64, 3/32, 7/64, 1/8, 9/64, 5/32, 3/16, 7/32, 1/4
	x5	2.5, 3, 4, 5, 6mm
	x5	2.5, 3, 4, 5, 6mm
	x18	PH00, PH0, PH1(x5), PH2(x5), PH3(x5), PH4
	x3	PH1, PH2, PH3
	x3	PH1, PH2, PH3
	x17	PZ00, PZ0, PZ1(x5), PZ2(x5), PZ3(x4), PZ4
	x3	PZ1, PZ2, PZ3
	x3	PZ1, PZ2, PZ3
	x14	T5, T6, T7, T8, T9, T10, T15, T20, T25, T27, T30, T35, T40, T45
	x7	T10, T15, T20, T25, T27, T30, T40
	x7	T10, T15, T20, T25, T27, T30, T40

	x3	6, 8, 10mm
	x3	6, 8, 10mm
	x4	4, 6, 8, 10mm
	x4	4, 6, 8, 10mm
	x4	1, 2, 3, 4mm
	x4	1, 2, 3, 4mm
	x6	2, 2.5, 3, 4, 5, 6mm
	x6	5/64, 3/32, 7/64, 1/8, 9/64, 5/32
	x13	T5, 6, 7, 8, 9, 10, 15, 20, 25, 27, 30, 40, 45
	x3	1, 2, 3mm
	x4	0, 1, 2, 3mm
	x3	M5, M6, M8
	x9	TS10, TS15, TS20, TS25, TS27, TS30, TS40, TS45, TS50

	x12	SL2, SL2.5, SL3, SL3.5, SL4, SL4.5, SL5, SL5.5, SL6, SL6.5, SL7, SL8
	x10	4, 5, 6, 7, 8, 9, 10, 11, 12, 13
	x10	5/32, 3/16, 7/32, 1/4, 9/32, 5/16, 11/32, 3/8, 7/16, 1/2
	x1	1/4"
	x1	
	x1	



52620

8,80€

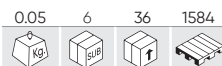

ANGLE DRILL ADAPTOR

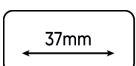

- Bit holder suitable for narrow spaces
- Extra low profile (37mm)
- Quick-release function
- Drill: 6mm

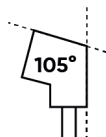

TOOL SETS

53156

26,20€

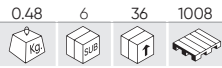

38 PIECES MINI RATHCET SET 1/4"



IT CONTAINS

		1/4" x11	4, 4.5, 5, 6, 7, 8, 9, 10, 11, 12, 13mm		x5	4, 5, 6, 7, 8mm
		1/4" x1			x3	SL6, SL8, SL10
		x2	PH3, PH4		x8	T8, T9, T10, T15, T20, T25, T30, T40
		x2	PZ3, PZ4		x4	M5, M6, M9, M10
					x1	1/4"

52198

37,70€

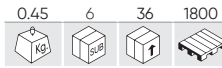

38 PIECES MINI RATHCET SET 1/4"

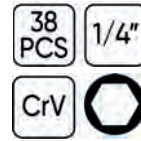

IT CONTAINS

		1/4" x11	4, 4.5, 5, 6, 7, 8, 9, 10, 11, 12, 13mm		x5	4, 5, 6, 7, 8mm
		1/4" x1			x3	SL6, SL8, SL10
		x2	PH3, PH4		x8	T8, T9, T10, T15, T20, T25, T30, T40
		x2	PZ3, PZ4		x4	M5, M6, M9, M10
					x1	1/4"

51333

18,00€

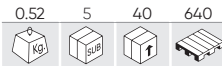

6 PIECES SOCKET ADAPTOR SET

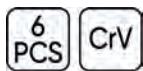

SPARE PARTS AVAILABLE

REF.	mm				€
11360	1/4H - 3/8M	0.03	10	100	2,60€
11361	1/4M - 3/8H	0.03	5	300	3,20€
11362	1/2H - 3/4M	0.14	10	100	5,20€
11363	3/8H - 1/2M	0.50	10	100	3,90€
11364	1/2H - 3/8M	0.05	10	100	4,50€
11365	3/4H - 1/2M	0.14	10	100	9,40€

53743

39,70€

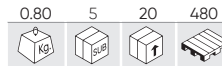

6 PIECES IMPACT SOCKET ADAPTOR SET



SPARE PARTS AVAILABLE

REF.	mm				€
14749	1/4"H - 3/8"M	0.03	20	200	2,00€
14750	3/8"H - 1/4"M	0.05	20	100	2,00€
14751	3/8"H - 1/2"M	0.15	20	100	4,00€
14752	1/2"H - 3/8"M	0.16	10	100	4,00€
11962	1/2"H - 3/4"M	0.17	10	100	7,50€
11964	3/4"H - 1/2"M	0.35	10	100	12,50€



52714 15,70€

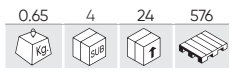

10 PIECES HEXAGONAL SOCKET SET

10 PCS 1/2" CrV
10, 11, 12, 13, 14, 15, 16, 17, 18, 19mm



52716 15,90€

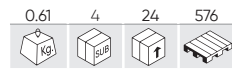

10 PIECES 12-POINT SOCKET SET

10 PCS 1/2" CrV
10, 11, 12, 13, 14, 15, 16, 17, 18, 19mm



52715 10,00€

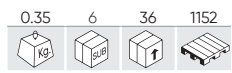

13 PIECES 1/4" HEXAGONAL SOCKET SET

13 PCS 1/4" CrV
4, 4.5, 5, 5.5, 6, 7, 8, 9, 10, 11, 12, 13, 14mm



52717 11,00€

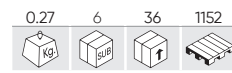

13 PIECES 1/4" 12-POINT SOCKET SET

13 PCS 1/4" CrV
4, 4.5, 5, 5.5, 6, 7, 8, 9, 10, 11, 12, 13, 14mm



51410 36,00€

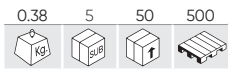

SET OF 6 1/2" PIECES - TORX TAMPER-PROOF BIT SOCKETS

6 PCS 1/2" CrV
T55, T60, T70, T80, T90, T100



51409 36,00€

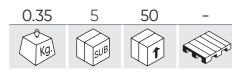

SET OF 6 PIECES - 1/2" TAMPER-PROOF 12-POINT XZN BIT SOCKETS

6 PCS 1/2" CrV
M10, M12, M14, M16, M18, M20



TOOL SETS

52909

12,50€

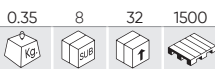

18 PIECES BIT SOCKET SET 1/4"

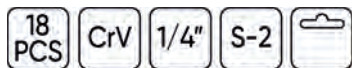

SPARE PARTS AVAILABLE

IT CONTAINS

	x2	PH1, PH2		x3	SL4, SL5.5, SL6.5
	x2	PZ1, PZ2		x7	T8, T10, T15, T20, T25, T27, T30
	x4	3, 4, 5, 6mm			

52908

17,00€

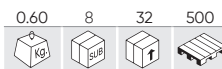

30 PIECES BIT SOCKET SET 1/4"

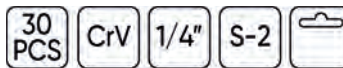

SPARE PARTS AVAILABLE

IT CONTAINS

	x3	PH0, PH1, PH2		x4	SL4, SL5.5, SL6.5, SL7
	x3	PZ0, PZ1, PZ2		x8	T8, T9, T10, T15, T20, T25, T27, T30
	x4	3, 4, 5, 6mm		x8	T8, T9, T10, T15, T20, T25, T27, T30

53084

24,00€

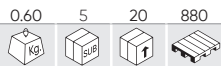

7 PIECES BIT SOCKET SET 3/8" - 1/2" TORX

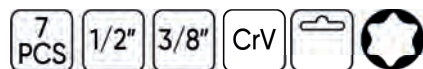

SPARE PARTS AVAILABLE

	1/2"	T55, T60, T70		3/8"	T30, T40, T45, T50
--	------	---------------	--	------	--------------------

53127

12,00€

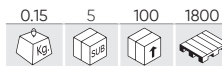

7 PIECES BIT SOCKET SET 1/4" TORX TAMPER-PROOF



SPARE PARTS AVAILABLE

	3/8"	T10, T15, T20, T25, T30, T40, T45
--	------	-----------------------------------

51746

12,00€

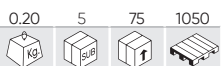

7 PIECES BIT SOCKET SET TS 5-POINT TAMPER-PROOF



TS10, TS15, TS20, TS25, TS30, TS40, TS45	
--	--



50980

22,00€

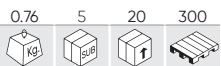

7 PIECES BIT SOCKET SET RIBE TIPS



	1/2"	100mm	M12, M13, M14
	3/8"	90mm	M6, M7, M8, M10

50982

22,00€



7 PIECES BIT SOCKET SET HEX BALL POINT



	3/8"	100mm	
	HB3	4, 5, 6, 7, 8, 10mm	

52320

22,00€

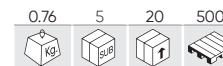

7 PIECES BIT SOCKET SET 12-POINT



	1/2"	100mm	M12, M13, M14
	3/8"	90mm	M6, M7, M8, M10

12029 5,50€



BIT SOCKET 1/2" XZN TAMPERPROOF M16X58MM SP. VAG



12030 6,50€



BIT SOCKET 1/2" XZN TAMPERPROOF M16X100MM SP. VAG



EXTRA-LONG 12-POINT BIT SOCKET 800mm 1/2"

REF.	DESCRIPTION					€
52059	Ø 8mm - 800mm	0.57	-	25	1750	29,00€
52060	Ø 10mm - 800mm	0.57	-	25	1750	32,00€
53667	Ø 12mm - 800mm	0.80	10	20	-	32,00€
53668	Ø 14mm - 800mm	1.05	10	20	-	34,00€



54091 441,00€



26 PIECES INSULATED TOOL SET



54093 441,00€



26 PIECES INSULATED TOOL SET IN EVA TRAY

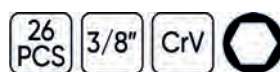
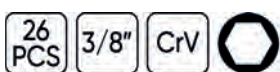

IT CONTAINS

	3/8" x10	8, 10, 11, 12, 13, 14, 16, 17, 18, 19, 21, 22mm
	3/8" x1	200mm
	1/2" x1	125mm
	3/8" x1	200mm

	x2	4x100mmL, 5,5x125mmL
	x2	PH1x80mm, PH2x100mm
	x1	185mm
	x1	

	x6	7x86, 8x99, 10x109, 12x127, 14x141, 17x156mm
	x1	185mm

15162

30,20€

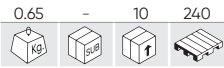

8 PIECES INSULATED SCREWDRIVER SET EVA TRAY CARBON FIBER FINISH



SPARE PARTS AVAILABLE

REF.	Ø	kg	10	50	€
15227	0.5x3.0x75mm	0,02	10	50	3,50€
15228	0.8x4.0x100mm	0,05	10	50	4,00€
15229	1.0x5.5x125mm	0,08	5	50	5,00€
15230	1.2x6.5x150mm	0,11	5	50	5,00€
15231	PH0x75mm	0,02	10	50	3,50€
15232	PH1x80mm	0,05	10	50	4,00€
15233	PH2x100mm	0,08	5	50	5,00€
15234	Voltage tester 140mm	0,02	10	50	3,00€



- ⊖ x4 0.5x3.0x75, 0.8x4.0x100, 1.0x5.5x125, 1.2x6.5x150mm
- ⊕ x3 PH0x75, PH1x80, PH2x100mm
- ⚡ x1 SL3x140mm

53154

462,00€

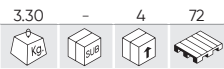

20 PIECES INSULATED TOOL SET 3/8"



IT CONTAINS

⊖	3/8"	x12	8, 10, 11, 12, 13, 14, 16, 17, 18, 19, 21, 22mm
⊕	3/8"	x1	200mm
⊕	3/8"	x2	125, 250mm
⊕	3/8"	x1	200mm
⚡	3/8"	x4	75mm, 4, 5, 6, 8mm

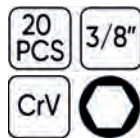

52519

25,50€

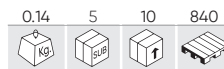

7 PIECES INSULATED SCREWDRIVERS UP TO 1.000V SET

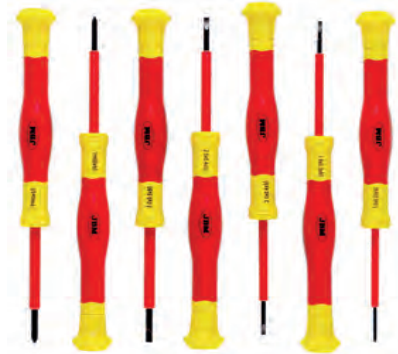

IT CONTAINS

- ⊕ x2 PH00x50, PH0x50mm
- ⊖ x5 SL1.5x0.23x50, SL1.8x0.30x50, SL2.0x0.40x50, SL2.5x0.40x50, SL3.0x0.50x50mm

INSULATED KNIFE

REF.	DESCRIPTION	kg	6	36	1152	€
53164	STRAIGHT	0.10	6	36	1152	16,50€
53165	HOOK	0.10	6	36	1152	19,60€



HAND TOOLS

- 38 SPANNERS
- 48 BAR CLAMP
- 49 RATCHET
- 51 TORQUE WRENCHES
- 53 EXTENSION BARS
- 53 SCREWDRIVERS
- 56 PLIERS
- 62 INSPECTION TOOLS
- 63 HAMMERS
- 64 CUTTING TOOLS
- 65 CHISELS
- 66 RIVETERS
- 68 MEASURING TOOLS
- 69 VARIOUS

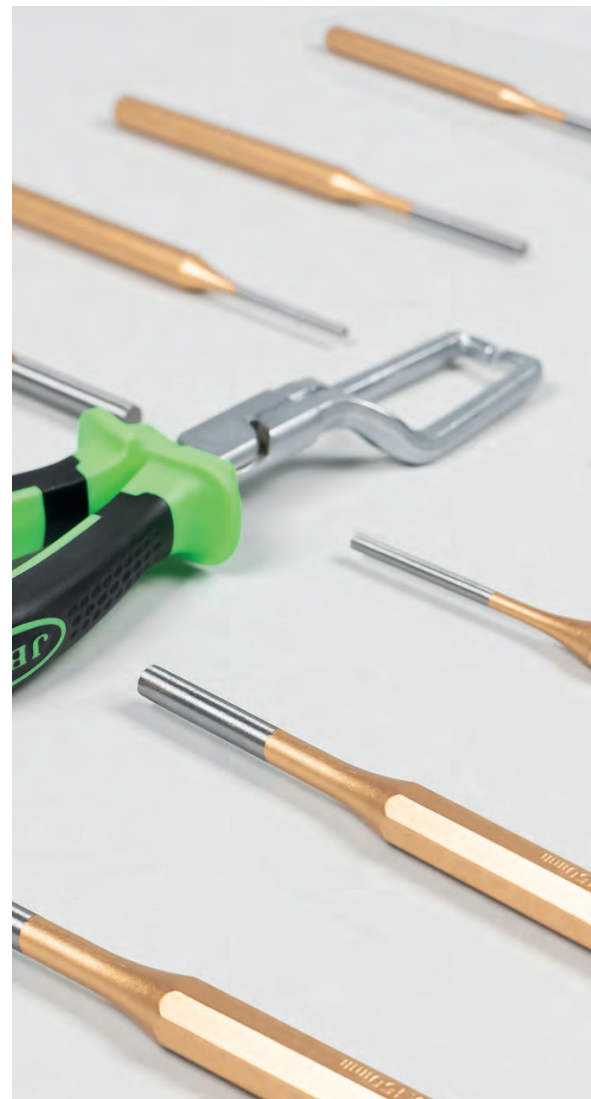

HAND TOOLS

54101

61,00€

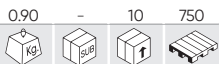

6 PIECES RATCHETING COMBINATION SPANNER SET



8x9, 10x11, 12x13, 14x15, 16x18, 17x19mm



SPARE PARTS AVAILABLE

REF.	mm	Kg	Box	Box	€
15632	8x9	0.04	10	100	9,00€
15633	10x11	0.07	10	100	9,50€
15634	12x13	0.11	10	100	11,00€

REF.	mm	Kg	Box	Box	€
15635	14x15	0.13	10	100	12,50€
15636	16x18	0.19	10	100	14,00€
15637	17x19	0.25	10	100	15,00€

53017

57,00€

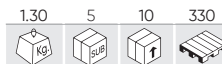

7 PIECES FLEXIBLE HEAD RATCHETING COMBINATION SPANNER SET



8, 10, 11, 13, 14, 17, 19 mm



SPARE PARTS AVAILABLE

REF.	mm	Kg	Box	Box	€
10552	8	0.06	10	100	7,10€
10554	10	0.09	10	100	7,50€
10555	11	0.09	10	100	7,80€
10557	13	0.13	10	100	8,10€

REF.	mm	Kg	Box	Box	€
10558	14	0.14	5	100	9,35€
10561	17	0.22	10	100	11,00€
10563	19	0.28	10	100	12,50€

54117

74,00€

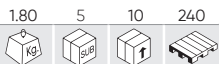

12 PCS COMBINATION RATCHET WRENCH SET



8, 9, 10, 11, 12, 13, 14, 15, 16, 17, 18, 19 mm



SPARE PARTS AVAILABLE

REF.	mm	Kg	Box	Box	€
13465	8	0.05	10	100	5,55€
13466	9	0.06	10	100	5,55€
13467	10	0.10	10	100	6,00€
13468	11	0.08	10	100	6,25€
13469	12	0.09	10	100	6,25€
13470	13	0.10	10	100	6,60€

REF.	mm	Kg	Box	Box	€
13471	14	0.11	10	100	6,90€
13472	15	0.13	10	100	7,25€
13473	16	0.15	10	100	8,10€
13474	17	0.19	10	100	8,70€
13475	18	0.22	10	100	9,10€
13476	19	0.22	10	100	9,60€

51318

98,00€

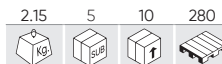

12 PIECES FLEXIBLE HEAD RATCHETING COMBINATION SPANNER SET



8, 9, 10, 11, 12, 13, 14, 15, 16, 17, 18, 19 mm



SPARE PARTS AVAILABLE

REF.	mm	Kg	Box	Box	€
10552	8	0.06	10	100	7,10€
10553	9	0.07	10	100	7,35€
10554	10	0.09	10	100	7,50€
10555	11	0.09	10	100	7,80€
10556	12	0.11	10	100	8,10€
10557	13	0.13	10	100	8,10€

REF.	mm	Kg	Box	Box	€
10558	14	0.14	5	100	9,35€
10559	15	0.16	10	100	9,50€
10560	16	0.19	5	50	10,60€
10561	17	0.22	10	100	11,00€
10562	18	0.26	5	100	12,30€
10563	19	0.28	10	100	12,50€

54338

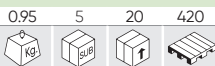

60,00€

N

RATCHET WRENCH WITH INTERCHANGEABLE HEAD 12 PCS

SPARE PARTS AVAILABLE

REF.	mm				€	REF.	mm				€
16391	8	0.01	30	100	4,60€	16397	14	0.05	30	100	5,50€
16392	9	0.05	30	100	4,60€	16398	15	0.05	30	100	5,50€
16393	10	0.05	30	100	4,60€	16399	16	0.05	30	100	5,50€
16394	11	0.05	30	100	5,10€	16401	17	0.05	30	100	6,10€
16395	12	0.05	30	100	5,10€	16402	18	0.05	30	100	6,10€
16396	13	0.05	30	100	5,10€	16403	19	0.10	30	100	6,10€



15316

58,00€

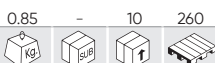

72 TEETH DOUBLE END RATCHET RING WRENCH SET « 4 IN 1 »



SPARE PARTS AVAILABLE

REF.	mm				€
15515	12-13mm x 8-10mm	0.15	10	50	15,50€
15516	14-15mm x 9-11mm	0.20	10	50	19,00€
15517	18-19mm x 16-17mm	0.40	5	50	22,50€

54066

83,00€



7 PIECES EXTRA-LONG RATCHET RING SPANNER SET



SPARE PARTS AVAILABLE

REF.	mm				€	REF.	mm				€
13453	8	0.10	6	36	9,00€	13457	14	0.25	6	36	12,00€
13454	10	0.15	10	100	9,50€	13460	17	0.40	6	24	15,00€
13455	12	0.20	6	36	10,50€	13462	19	0.50	6	24	17,00€
13456	13	0.20	6	36	11,50€						

54032

84,00€

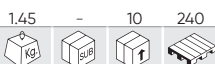

12 PIECES STUBBY FLEXIBLE RATCHET RING SPANNER SET



SPARE PARTS AVAILABLE

REF.	mm				€	REF.	mm				€
15328	8	0.05	12	96	6,00€	15334	14	0.11	12	96	7,00€
15329	9	0.05	12	96	5,50€	15335	15	0.13	12	96	7,50€
15330	10	0.05	12	96	5,50€	15336	16	0.14	12	96	8,00€
15331	11	0.07	12	96	5,50€	15337	17	0.16	12	96	8,50€
15332	12	0.09	12	96	6,00€	15338	18	0.18	12	96	9,00€
15333	13	0.10	12	96	6,50€	15339	19	0.20	12	96	9,50€

15122

74,00€

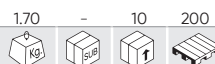

12 PIECES COMBINATION RATCHET WRENCH SET IN CARBON FIBER FINISH EVA TRAY



SPARE PARTS AVAILABLE

REF.	mm				€	REF.	mm				€
13465	8	0.05	10	100	5,55€	13471	14	0.11	10	100	6,90€
13466	9	0.06	10	100	5,55€	13472	15	0.13	10	100	7,25€
13467	10	0.10	10	100	6,00€	13473	16	0.15	10	100	8,10€
13468	11	0.08	10	100	6,25€	13474	17	0.19	10	100	8,70€
13469	12	0.09	10	100	6,25€	13475	18	0.22	10	100	9,10€
13470	13	0.10	10	100	6,60€	13476	19	0.22	10	100	9,60€

53018

119,00€



6 PIECES FLEXIBLE RATCHET WRENCH SET



8x9, 10x11, 12x13,
14x15, 16x18, 17x19mm



SPARE PARTS AVAILABLE

REF.	mm				€
13447	8x9	0.10	6	36	16,50€
13448	10x11	0.15	6	36	17,50€
13449	12x13	0.25	6	36	20,00€

REF.	mm				€
13450	14x15	0.30	6	36	23,00€
13451	16x18	0.35	6	24	28,00€
13452	17x19	0.40	6	24	29,50€



54110

46,00€

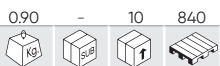

8 PIECES STUBBY RETCHETING WRENCH SET



10, 11, 12, 13, 14,
15, 17, 19mm

SPARE PARTS AVAILABLE

REF.	mm				€
13491	10	0.05	10	100	5,30€
13492	11	0.06	10	100	5,35€
13493	12	0.07	10	100	5,50€
13494	13	0.08	5	100	6,00€

REF.	mm				€
13495	14	0.09	10	100	6,40€
13496	15	0.12	10	100	6,60€
13497	17	0.14	10	100	7,50€
13498	19	0.19	10	100	8,50€



54041

198,00€

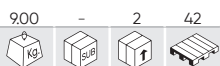

22 PIECES COMBINATION RATCHET WRENCH SET



6, 7, 8, 9, 10, 11, 12, 13, 14, 15, 16,
17, 18, 19, 20, 21, 22, 23, 24,
27, 30, 32mm

SPARE PARTS AVAILABLE

REF.	mm				€
13463	6	0.03	10	100	5,30€
13464	7	0.04	10	100	5,30€
13465	8	0.05	10	100	5,55€
13466	9	0.06	10	100	5,55€
13467	10	0.10	10	100	6,00€
13468	11	0.08	10	100	6,25€
13469	12	0.09	10	100	6,25€
13470	13	0.10	10	100	6,60€
13471	14	0.11	10	100	6,90€
13472	15	0.13	10	100	7,25€
13473	16	0.15	10	100	8,10€

REF.	mm				€
13474	17	0.19	10	100	8,70€
13475	18	0.22	10	100	9,10€
13476	19	0.22	10	100	9,60€
13477	20	0.23	6	60	9,85€
13478	21	0.37	6	60	12,20€
13479	22	0.37	6	60	13,10€
13480	23	0.37	6	48	15,50€
13481	24	0.53	6	48	15,80€
13482	27	0.60	6	24	22,10€
13483	30	0.80	6	24	25,50€
13484	32	1.12	6	24	27,20€



54079

83,00€

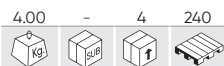

21 PIECES COMBINATION SPANNER SET

21 PCS 6, 7, 8, 9, 10, 11, 12, 13, 14, 15, 16, 17, 18, 19, 20, 21, 22, 24, 27, 30, 32mm

SPARE PARTS AVAILABLE

REF.	mm	kg	SUB	mm	€
10531	10	0.05	10	100	3,00€
10532	11	0.06	10	100	2,70€
10533	12	0.07	10	100	3,00€
10534	13	0.08	10	100	3,25€
10535	14	0.10	10	100	3,50€
10536	15	0.10	10	100	3,65€
10537	16	0.11	10	100	3,90€
10538	17	0.14	10	100	4,30€
10539	18	0.16	10	100	4,75€

REF.	mm	kg	SUB	mm	€
10540	19	0.20	10	100	5,25€
10541	20	0.21	6	60	5,55€
10542	21	0.25	-	50	5,85€
10543	22	0.25	-	50	7,00€
10544	24	0.33	10	100	8,10€
10545	27	0.41	10	50	9,75€
10546	30	0.52	-	25	11,60€
10547	32	0.59	-	25	13,50€
10548	6	0.03	10	100	1,75€

REF.	mm	kg	SUB	mm	€
10549	7	0.03	10	100	2,00€
10550	8	0.03	10	100	2,15€
10551	9	0.04	10	100	2,15€



54097

38,90€

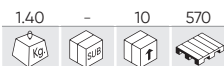

SET OF 14 COMBINATION SPANNERS

14 PCS CrV 6, 7, 8, 9, 10, 11, 12, 13, 14, 15, 16, 17, 18, 19 mm

SPARE PARTS AVAILABLE

REF.	mm	kg	SUB	mm	€
10531	10	0.05	10	100	3,00€
10532	11	0.06	10	100	2,70€
10533	12	0.07	10	100	3,00€
10534	13	0.08	10	100	3,25€
10535	14	0.10	10	100	3,50€
10536	15	0.10	10	100	3,65€
10537	16	0.11	10	100	3,90€

REF.	mm	kg	SUB	mm	€
10538	17	0.14	10	100	4,30€
10539	18	0.16	10	100	4,75€
10540	19	0.20	10	100	5,25€
10548	6	0.03	10	100	1,75€
10549	7	0.03	10	100	2,00€
10550	8	0.03	10	100	2,15€
10551	9	0.04	10	100	2,15€



54120

59,00€



7 PIECES COMBINATION SPANNER SET

7 PCS CrV 20, 21, 22, 24, 27, 30, 32mm



SPARE PARTS AVAILABLE

REF.	mm	kg	SUB	mm	€
10541	20	0.21	6	60	5,55€
10542	21	0.25	-	50	5,85€
10543	22	0.25	-	50	7,00€
10544	24	0.33	10	100	8,10€

REF.	mm	kg	SUB	mm	€
10545	27	0.41	10	50	9,75€
10546	30	0.52	-	25	11,60€
10547	32	0.59	-	25	13,50€

54174

139,00€



6 PIECES COMBINATION SPANNER SET

6 PCS CrV XL 34, 36, 38, 41, 46, 50mm



SPARE PARTS AVAILABLE

REF.	mm	kg	SUB	mm	€
16020	34	0.36	10	100	17,00€
16021	36	0.00	10	100	19,50€
16022	38	0.43	10	100	23,00€

REF.	mm	kg	SUB	mm	€
16023	41	0.47	10	100	26,50€
16024	46	0.51	10	100	34,50€
16025	50	0.58	10	100	37,50€

HAND TOOLS

50564

30,00€

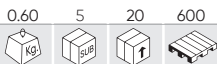

8 PIECES SHORT COMBINATION SPANNER SET



SPARE PARTS AVAILABLE

REF.	mm	Kg	SUB	PCS	€	REF.	mm	Kg	SUB	PCS	€	REF.	mm	Kg	SUB	PCS	€
10564	10	0.05	10	100	2,50€	10567	13	0.05	10	100	3,50€	10570	17	0.10	10	100	4,50€
10565	11	0.05	10	100	3,50€	10568	14	0.05	10	100	4,00€	10571	19	0.15	10	100	5,00€
10566	12	0.05	10	100	3,50€	10569	15	0.05	10	100	4,50€						

54150

23,50€

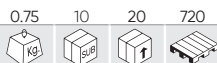

7 PIECES DOUBLE OPEN END SPANNER SET

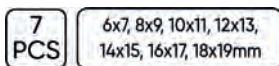

SPARE PARTS AVAILABLE

REF.	mm	Kg	SUB	PCS	€	REF.	mm	Kg	SUB	PCS	€
10579	10x11	0.06	10	100	3,00€	10583	18x19	0.19	10	100	4,15€
10580	12x13	0.07	10	100	3,10€	10589	6x7	0.03	10	100	2,00€
10581	14x15	0.10	10	100	3,40€	10590	8x9	0.04	10	100	2,40€
10582	16x17	0.14	10	100	4,00€						

54149

60,00€



12 PIECES DOUBLE OPEN END SPANNER SET

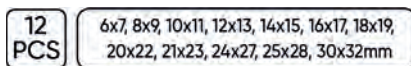

SPARE PARTS AVAILABLE

REF.	mm	Kg	SUB	PCS	€	REF.	mm	Kg	SUB	PCS	€
10579	10x11	0.06	10	100	3,00€	10585	21x23	0.31	-	50	6,75€
10580	12x13	0.07	10	100	3,10€	10586	24x27	0.35	10	100	7,60€
10581	14x15	0.10	10	100	3,40€	10587	25x28	0.36	-	50	9,80€
10582	16x17	0.14	10	100	4,00€	10588	30x32	0.54	-	25	10,50€
10583	18x19	0.19	10	100	4,15€	10589	6x7	0.03	10	100	2,00€
10584	20x22	0.25	6	60	5,05€	10590	8x9	0.04	10	100	2,40€

52973

59,00€



12 PIECES DOUBLE OPEN END SPANNER SET - CHROME FINISH

SPARE PARTS AVAILABLE

REF.	mm	Kg	SUB	PCS	€	REF.	mm	Kg	SUB	PCS	€
10579	10x11	0.06	10	100	3,00€	10585	21x23	0.31	-	50	6,75€
10580	12x13	0.07	10	100	3,10€	10586	24x27	0.35	10	100	7,60€
10581	14x15	0.10	10	100	3,40€	10587	25x28	0.36	-	50	9,80€
10582	16x17	0.14	10	100	4,00€	10588	30x32	0.54	-	25	10,50€
10583	18x19	0.19	10	100	4,15€	10589	6x7	0.03	10	100	2,00€
10584	20x22	0.25	6	60	5,05€	10590	8x9	0.04	10	100	2,40€



6x7, 8x9, 10x11, 12x13, 14x15, 16x17, 18x19, 20x22, 21x23, 24x27, 25x28, 30x32mm



54115 26,80€



4 PIECES FLAT TORX SPANNER SET

4 PCS E6xE8, E10xE12, E14xE18, E20xE24



SPARE PARTS AVAILABLE

REF.	mm				€
16546	E6xE8	0.05	10	100	5,00€
16547	E10xE12	0.07	10	100	5,50€
16548	E14xE18	0.08	10	100	9,00€
16549	E20xE24	0.09	10	100	14,00€

54081 28,00€



5 PIECES OPEN RING END SPANNER SET

5 PCS 10x11HEX, 12x13HEX, 14x15HEX, 16x17HEX, 18x19HEX



SPARE PARTS AVAILABLE

REF.	mm				€
11258	10x11	0.10	5	100	7,30€
11259	12x13	0.10	5	100	8,30€
11260	14x15	0.11	5	100	9,75€
11261	16x17	0.18	5	100	11,35€
11262	18x19	0.21	-	100	13,50€

54159 47,00€



8 PIECES 12-POINT "C" TYPE STARTER & BLOCK WRENCH SPANNER SET

8 PCS

6x7, 8x9, 10x11, 12x13, 14x15, 16x17, 18x19, 20X22mm



SPARE PARTS AVAILABLE

REF.	mm				€
11639	6x7	0.61	5	50	4,00€
11640	8x9	0.04	5	50	4,50€
11641	10x11	0.04	5	50	5,00€
11642	12x13	0.06	5	50	5,00€
11643	14x15	0.09	5	-	6,00€
11644	16x17	0.12	5	50	7,00€
11645	18x19	0.15	5	50	7,00€
11646	20x22	0.22	5	-	9,45€

52451 42,00€



8 PIECES 12-POINT STARTER & BLOCK WRENCH SPANNER SET

8 PCS

6x7, 8x9, 10x11, 12x13, 14x15, 16x17, 18x19, 20X22mm



SPARE PARTS AVAILABLE

REF.	mm				€
11639	6x7	0.61	5	50	4,00€
11640	8x9	0.04	5	50	4,50€
11641	10x11	0.04	5	50	5,00€
11642	12x13	0.06	5	50	5,00€
11643	14x15	0.09	5	-	6,00€
11644	16x17	0.12	5	50	7,00€
11645	18x19	0.15	5	50	7,00€
11646	20x22	0.22	5	-	9,45€

15156 70,00€



4 PIECES DOUBLE RING SPANNER SET IN CARBON FIBER FINISH EVA TRAY

SPARE PARTS AVAILABLE

REF.	mm				€
15206	21x23	0.45	5	50	15,00€
15207	24x27	0.50	5	50	16,50€
15208	25x28	0.45	5	50	17,00€
15209	30x32	0.67	10	50	18,00€

4 PCS 21x23, 24x27, 25x28, 30x32mm



HAND TOOLS

54119

78,00€



12 PIECES DOUBLE OFFSET RING SPANNER SET

12 PCS 6x7, 8x9, 10x11, 12x13, 14x15, 16x17, 18x19, 20x22, 21x23, 24x27, 25x28, 30x32mm



SPARE PARTS AVAILABLE

REF.	mm				€	REF.	mm				€
10627	6x7	0.04	10	100	2,80€	10633	18x19	0.22	10	100	6,60€
10628	8x9	0.06	10	100	3,10€	10634	20x22	0.43	-	50	7,80€
10629	10x11	0.08	10	100	3,65€	10635	21x23	0.30	-	50	8,15€
10630	12x13	0.11	10	100	3,90€	10636	24x27	0.35	-	25	8,80€
10631	14x15	0.14	10	100	4,20€	10637	25x28	0.48	6	24	12,10€
10632	16x17	0.18	10	100	5,30€	10638	30x32	0.73	6	24	12,70€

50562

23,50€

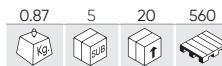

7 PIECES DOUBLE OFFSET RING SPANNER SET

7 PCS 6x7, 8x9, 10x11, 12x13, 14x15, 16x17, 18x19mm



SPARE PARTS AVAILABLE

REF.	mm				€	REF.	mm				€
10627	6x7	0.04	10	100	2,80€	10631	14x15	0.14	10	100	4,20€
10628	8x9	0.06	10	100	3,10€	10632	16x17	0.18	10	100	5,30€
10629	10x11	0.08	10	100	3,65€	10633	18x19	0.22	10	100	6,60€
10630	12x13	0.11	10	100	3,90€						

51528

49,00€

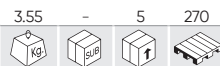

14 PIECES ANGLED OPEN SOCKET WRENCH SET

14 PCS 8, 9, 10, 11, 12, 13, 14, 15, 16, 17, 18, 19, 20, 21mm



SPARE PARTS AVAILABLE

REF.	mm				€	REF.	mm				€
10591	10	0.09	10	200	2,50€	10598	17	0.32	10	60	4,60€
10592	11	0.12	10	200	2,55€	10599	18	0.43	10	40	6,00€
10593	12	0.16	10	120	3,15€	10600	19	0.41	10	40	6,25€
10594	13	0.17	10	100	3,20€	10601	20	0.45	10	30	6,50€
10595	14	0.20	10	100	3,35€	10602	21	0.47	10	30	7,05€
10596	15	0.25	10	70	4,25€	10603	8	0.07	10	300	2,10€
10597	16	0.30	10	70	4,50€	10604	9	0.08	10	200	2,25€

53420

72,00€



8 PIECES TUBULAR WRENCH SET

8 PCS 6x7, 8x9, 10x11, 12x13, 14x15, 16x17, 18x19, 20x22mm



53979

34,60€

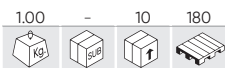

8 PIECES T-HANDLE KEY SET



T10x75, T15x75, T20x100, T25x100, T30x150, T40x150, T45x200, T50x200mm

53980

34,60€

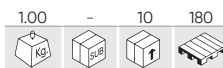

8 PIECES BALL END T-HANDLE KEY SET

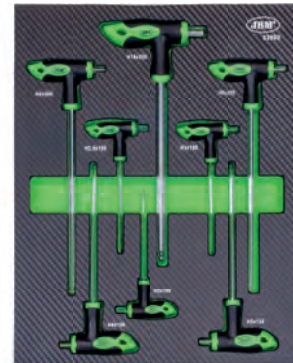

H2x100, H2.5x100, H3x100, H4x150, H5x150, H6x200, H8x200, H10x200

6 PIECES 12-POINT EXTRA LONG SPANNER SETS

51864

64,00€

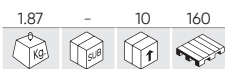

10x11mm (290mmL), 12x14mm (330mmL), 13x15mm (368mmL), 16x18mm (407mmL), 17x19mm (407mmL), 22x24mm (430mmL)



52912

91,00€



E6xE7 (200mmL), E8xE10 (235mmL), E11xE12 (290mmL), E14xE16 (370mmL), E18xE20 (410mmL), E22xE24 (420mmL)



SPARE PARTS AVAILABLE

REF.	mm	kg	boxes	units	€
11244	10x11	0.13	5	100	8,50€
11245	12x14	0.18	10	50	9,15€
11246	13x15	0.25	6	36	12,40€

REF.	mm	kg	boxes	units	€
11247	16x18	0.30	6	36	14,00€
11248	17x19	0.31	10	36	14,60€
11249	22x24	0.43	5	-	26,50€

9 PCS KEY SET

TORX

REF.	mm	DESCRIPTION	kg	boxes	units	€
53737	90-218mm	9 PIECES EXTRA LONG TORX KEY SET	0.42	10	40	12,50€
53739	86-150mm	9 PIECES LONG TORX KEY SET	0.32	10	40	10,50€
53955	72-170mm	9 PIECES SHORT TORX KEY SET	0.25	10	40	14,80



T10, T15, T20, T25, T27, T30, T40, T45, T50



HEXAGONAL

REF.	mm	DESCRIPTION	kg	boxes	units	€
53738	90-220mm	9 PIECES EXTRA LONG HEX. KEY SET WITH ROUND TIP	0.45	10	40	10,90€
53740	72-170mm	9 PIECES LONG HEX. KEY SET WITH ROUND TIP	0.37	10	40	9,10€
53954	43-97mm	9 PIECES SHORT HEX. KEY SET WITH ROUND TIP	0.25	10	40	14,80



1.5, 2, 2.5, 3, 4, 5, 6, 8, 10mm

HAND TOOLS

51659

59,00€

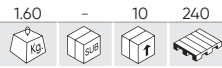

CASE WITH 6 HINGED SOCKET WRENCH SET 12-POINT

6 PCS



8x9, 10x11, 12x13, 14x15, 16x17, 18x19mm



SPARE PARTS AVAILABLE

REF.	mm				€
10621	8-9	0.09	10	100	9,50€
10622	10-11	0.13	10	100	10,00€
10623	12-13	0.16	5	100	12,60€

50622

64,00€

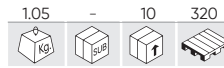

SET OF 4 TORX HINGED SOCKET WRENCH SET

4 PCS



E6 x E8, E10 x E12, E14 x E18, E20 x E24



SPARE PARTS AVAILABLE

REF.	mm				€
10617	E6x E8	0.07	10	100	14,10€
10618	E10x E12	0.11	10	100	15,10€
10619	E14x E18	0.20	10	100	15,70€
10620	E20x E24	0.34	10	100	16,20€

54187

39,30€

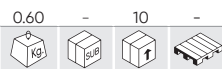

10 PIECES CROWFOOT WRENCH SET 3/8"

SPARE PARTS AVAILABLE

REF.	mm				€
16010	10	0.04	10	100	4,00€
16011	11	0.04	10	100	4,00€
16012	13	0.04	10	100	4,00€
16013	14	0.05	10	100	4,50€
16014	15	0.05	10	100	4,50€

REF.	mm				€
16015	16	0.05	10	100	5,00€
16016	17	0.05	10	100	5,00€
16017	18	0.06	10	100	5,00€
16018	19	0.06	10	100	5,50€
16019	22	0.08	10	100	6,00€

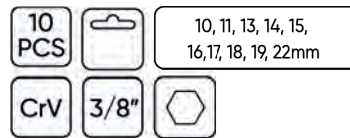

SAE TOOLS

51890

92,00€



17 PIECES COMBINATION SPANNER SET SAE

17 PCS

5/16, 3/8, 7/16, 1/2, 9/16, 19/32, 5/8, 11/16, 3/4, 13/16, 7/8, 15/16, 1", 1 1/16, 1 1/8, 1 3/16, 1 1/4



54005

14,00€

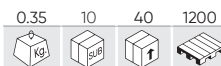

9 PIECES HEXAGONAL KEY SET SAE WITH ROUND TIP

9 PCS

CrV



1/16", 5/64", 3/32", 1/8", 5/32", 3/16", 1/4", 5/16", 3/8"

72-170mm



54106

89,00€



37-PIECE ZINC-FINISH INCH TOOL CASE

37 PCS

CrV

1/2"

1/4"



4-WAY WHEEL NUT WRENCH

51661 12,00€

1.17 5 20 360

1/2" 355mm

17, 19, 21mm

52880 42,00€

3.75 - 5 120

3/4" 700mm

24, 27, 32mm

52881 17,00€

1.40 - 10 480

1/2" 400mm

17, 19, 21, 22mm

51416 12,00€

1.05 10 20 360

TELESCOPIC WHEEL WRENCH WITH REVERSIBLE SOCKETS 330-490MM

1/2"

17/19mm
21/23mm

ADJUSTABLE WRENCH

MODEL 1

REF.	DESCRIPTION		mm					€
51798	ADJUSTABLE WRENCH 18"	53mm	450mm	1.90	3	12	480	39,60€
52424	ADJUSTABLE WRENCH 24"	62mm	610mm	3.75	-	5	350	64,00€



MODEL 2

REF.	DESCRIPTION		mm					€
51795	ADJUSTABLE WRENCH 8"	22mm	200mm	0.28	6	60	3600	9,00€
51796	ADJUSTABLE WRENCH 10"	28mm	250mm	0.48	6	36	2400	14,00€
51797	ADJUSTABLE WRENCH 12"	37mm	300mm	0.71	6	24	960	18,00€



MODEL 3

REF.	DESCRIPTION		mm					€
53639	ADJUSTABLE WRENCH 6"	28mm	150mm	0.15	6	96	576	28,60€
53640	ADJUSTABLE WRENCH 8"	30mm	200mm	0.28	6	72	504	34,40€
53641	ADJUSTABLE WRENCH 10"	33mm	250mm	0.50	6	36	1151	41,00€
53642	ADJUSTABLE WRENCH 12"	40mm	300mm	0.83	6	10	1200	54,00€
53643	ADJUSTABLE WRENCH 16"	52mm	400mm	1.53	-	12	336	92,00€
54098	ADJUSTABLE WRENCH 20"	65mm	640mm	2.70	-	6	-	158,50€



53654 81,00€

1.40 - 5 200











ADJUSTABLE C-SPANNER SET

8 PCS 35-60, 60-90, 90-120mm

160mm 177mm 250mm







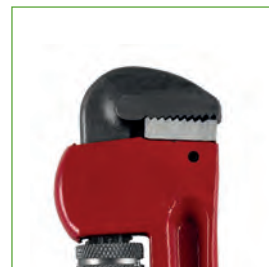

HAND TOOLS

PIPE WRENCH

REF.	DESCRIPTION		"					€	
52235	PIPE WRENCH 300MM		50mm	12"	0.90	6	24	1140	11,00€
52236	PIPE WRENCH 350MM		60mm	14"	1.09	6	24	760	13,30€
52237	PIPE WRENCH 450MM		70mm	18"	1.75	4	12	720	18,10€
52238	PIPE WRENCH 600MM		75mm	24"	2.50	2	8	600	24,90€
53210	PIPE WRENCH 915MM		110mm	36"	4.95	-	4	96	48,00€







ALUMINIUM ALLOY PIPE WRENCH

REF.	DESCRIPTION		mm					€	
53070	ALUMINIUM ALLOY PIPE WRENCH 12"		45mm	270mm	0.68	6	24	900	16,20€
53071	ALUMINIUM ALLOY PIPE WRENCH 14"		50mm	320mm	0.92	4	12	900	26,10€
53072	ALUMINIUM ALLOY PIPE WRENCH 18"		65mm	410mm	1.35	4	12	900	31,60€
53073	ALUMINIUM ALLOY PIPE WRENCH 24"		75mm	540mm	2.05	2	8	1000	50,00€



ADJUSTABLE BAR CLAMP

REF.	DESCRIPTION					€
52349	ADJUSTABLE BAR CLAMP 90X200MM	1.25	-	10	480	22,10€
52350	ADJUSTABLE BAR CLAMP 90X300MM	1.41	-	10	540	22,60€
52351	ADJUSTABLE BAR CLAMP 90X400MM	1.60	-	10	480	25,40€
52352	ADJUSTABLE BAR CLAMP 120X300MM	1.99	-	10	360	32,40€
52353	ADJUSTABLE BAR CLAMP 120X400MM	2.10	-	10	350	33,40€
52354	ADJUSTABLE BAR CLAMP 120X500MM	2.41	-	6	300	34,40€
52355	ADJUSTABLE BAR CLAMP 120X600MM	2.62	-	4	300	36,60€
52357	ADJUSTABLE BAR CLAMP 150X800MM	4.60	-	5	125	54,00€
52358	ADJUSTABLE BAR CLAMP 150X1000MM	5.35	-	5	120	63,00€



72-TEETH RATCHET WITH SOCKETS

REF.	DESCRIPTION					€
54028	1/2" 72-TEETH RATCHET WITH HEX. SOCKETS	1.30	4	24	432	28,00€
54029	1/2" 72-TEETH RATCHET WITH 12-POINT SOCKETS	1.25	4	24	432	28,00€
54030	1/4" 72-TEETH RATCHET WITH HEX. SOCKETS	0.35	6	36	1008	18,80€
54031	1/4" 72-TEETH RATCHET WITH 12-POINT SOCKETS	0.35	6	36	864	19,30€



54028 - 54029	10, 11, 12, 13, 14, 15, 16, 17, 18, 19mm
54030 - 54031	4, 5, 6, 7, 8, 9, 10, 11, 12, 13mm

72-TEETH RATCHET

CHROME FINISH

REF.	DESCRIPTION					€
54022	1/4" 72-TEETH CHROMED RATCHET 145MM	0.15	12	36	1440	9,95€
54023	3/8" 72-TEETH CHROMED RATCHET 200MM	0.30	12	24	1440	13,50€
54024	1/2" 72-TEETH CHROMED RATCHET 255MM	0.60	12	24	960	17,90€



IN 12 UNITS DISPLAY CASE

ZINC FINISH

REF.	DESCRIPTION					€
54018	1/4" 72-TEETH ZINC FINISH RATCHET 145MM	0.15	12	36	1440	9,85€
54019	1/2" 72-TEETH ZINC FINISH RATCHET 255MM	0.60	12	24	864	17,90€
54021	3/8" 72-TEETH ZINC FINISH RATCHET 200MM	0.60	12	24	1440	13,50€



IN 12 UNITS DISPLAY CASE

72-TEETH STRAIGHT RATCHET

REF.	DESCRIPTION					€
54083	1/4" 72-TEETH STRAIGHT RATCHET	0.14	12	24	2592	9,75€
54084	3/8" 72-TEETH STRAIGHT RATCHET	0.30	12	24	1440	13,10€
54085	1/2" 72-TEETH STRAIGHT RATCHET	0.60	12	24	960	17,80€



IN 12 UNITS DISPLAY CASE

72-TEETH STUBBY RATCHET

REF.	DESCRIPTION					€
54086	1/4" 72-TEETH STUBBY RATCHET	0.10	12	24	2592	9,25€
54087	72-TEETH STUBBY RATCHET - 1/2"	0.50	12	24	1008	17,30€



IN 12 UNITS DISPLAY CASE

HAND TOOLS

52197

36,30€

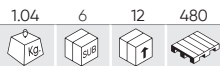

1/2" 72-TEETH DRIVE EXTENDABLE RATCHET

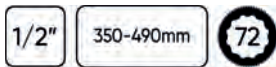

IN 6 UNITS DISPLAY CASE

52207

24,20€



1/4" MINI RATCHET WITH 72 TEETH 85MM - ZINC FINISH



IN 12 UNITS DISPLAY CASE

SHORT HINGED 72-TEETH RATCHET

REF.						€
52587	1/4" 172mm	0.16	12	144	3456	39,90€
52588	1/2" 172mm	0.17	12	144	3456	45,00€



IN 12 UNITS DISPLAY CASE



SHORT HINGED 72-TEETH RATCHET

REF.						€
51305	1/2" 175mm	0.31	12	48	816	28,90€
51306	1/4" 165mm	0.30	12	48	816	28,10€



IN 12 UNITS DISPLAY CASE



1/4" 72-TEETH SWIVEL HEAD RATCHET WITH T-HANDLE

REF.						€
51405	1/4" 145mm	0.58	12	24	-	21,10€
51406	1/2" 280mm	0.66	12	24	864	29,20€



IN 12 UNITS DISPLAY CASE



72-TEETH DRIVE EXTENDABLE RATCHET

REF.						€
51307	1/2" 305-445mm	0.92	6	12	360	29,70€
53346	1/4" 150-200mm	0.25	6	12	-	18,00€
54304	1/2" 450-610mm	1.15	-	6	480	26,00€



IN 6 UNITS DISPLAY CASE



72-TEETH FLEXIBLE EXTRA LONG DRIVE RATCHET

REF.	DESCRIPTION					€
53886	1/4" 305mm	0.27	10	40	1680	20,30€
53887	3/8" 457mm	0.68	10	20	700	30,30€
53888	1/2" 609mm	1.27	4	16	480	37,90€



SPARE SET

REF.	"					€
15147	3/8"	0.10	-	100	-	5,00€
15148	1/2"	0.20	-	100	-	5,00€

72-TEETH EXTRA LONG DRIVE RATCHET

REF.	DESCRIPTION					€
53883	1/4" 305mm	0.27	10	40	1680	18,40€
53884	3/8" 457mm	0.61	10	20	700	30,20€
53885	1/2" 609mm	1.25	4	16	480	35,70€



REF.	"					€
15149	1/4"	0.05	-	100	-	5,00€

51801

62,00€

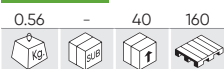

FLEXIBLE 72-TEETH RATCHET 3/8" 500MM



FOR PLACES THAT ARE DIFFICULT TO ACCESS

IT OPERATES ROTATING THE HANDLE

WITH ROTATING HEAD



53671

41,00€



3 PIECES STUBBY RATCHET SET



REPAIRING KIT FOR STUBBY RATCHET SET

REF.	DESCRIPTION					€
15138	1/4"	0.10	-	50	-	10,50€
15139	3/8"	0.15	-	50	-	12,00€
15140	1/2"	0.20	-	50	-	13,50€

54339

273,00€



DIGITAL TORQUE WRENCH 1/2" 10-200NM



N

52913

292,00€

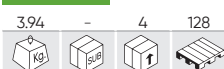

200NM TORQUE WRENCH WITH INTERCHANGEABLE HEAD

	x1	1/2"
	x9	13, 14, 15, 17, 19, 22, 24, 27, 30mm
	x1	40-200Nm

- Include factory calibration certificate.



1/2"

54269

56,00€



21 PCS SET WITH 1/4" DYNAMOMETRIC WRENCH

	x1	5-25Nm		x3	PH1, PH2, PH3
	x1	100mm		x8	H2, H2.5, H3, H4, H5, H6, H8, H10 (37mmL)
	x1	UNIVERSAL		x1	H5 (87mmL)
	x1	1/4" (F) - 3/8" (M)		x5	T10, T15, T20, T25, T30



1/4"

N

53972

550,00€



3/4" TORQUE WRENCH



200-800Nm
21.4-86.6M.Kg

1000-1210mm



- Include factory calibration certificate.

RATCHET TORQUE WRENCH

REF.	DESCRIPTION					€
53081	1/4" 4-20NM (36T) 375mm	1.10	5	25	350	115,00€
53082	1/2" 40-210NM (24T) 560mm	1.90	4	8	168	148,00€

- Include factory calibration certificate.



RATCHET TORQUE WRENCH

REF.	DESCRIPTION					€
51127	1/2" 28-210NM 470mm	1.70	4	8	256	56,00€
51262	1/4" 5-25NM 270mm	0.80	4	16	384	51,00€
51338	3/8" 19-110NM 365mm	1.05	4	16	384	53,00€



REPAIR KITS

REF.	"					€	REF.	"					€	REF.	"					€
51127R	1/2"	0.15	-	20	-	14,00€	51262R	1/4"	0.05	-	20	-	14,00€	51338R	3/8"	0.05	-	20	-	14,00€



51830

94,00€

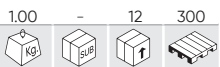

TORQUE SCREWDRIVER WITH WINDOW SCALE SET

- Exactness: CW: +/- 4%
- Operation range: 2-10 N-m
- Selection units: N-m, in-lb.
- Length (mm): 242
- Die: 1/4"
- Useful life: 2000 cycles

- Include factory calibration certificate.



SLIDING T BAR

REF.	DESCRIPTION					€
53468	1/2" 250mm	0.35	6	48	600	8,50€
53478	1/4" 115mm	0.50	5	100	1200	4,55€
53479	3/8" 200mm	0.15	5	50	300	6,40€
53480	3/4" 460mm	1.35	5	10	440	19,90€
53481	1" 550mm	2.85	-	5	300	27,40€



SWIVEL HEAD RATCHETED BREAKER BAR

REF.	DESCRIPTION						€
52524	3/4" 1020mm	3.60	3	6	144		51,00€
52526	1/2" 600mm	1.65	5	10	600		28,40€
52525	1/2" 430mm	0.85	10	20	1500		13,80€



SPARE SET

REF.	"					€
11945	1/2"	0.15	25	100	-	7,00€

FOR 52526

REF.	"					€
11946	1/2"	0.06	25	300	-	4,50€

FOR 52525

REF.	"					€
11947	3/4"	0.51	10	40	960	19,00€

FOR 52524



54343

31,00€

1.15	-	6	594
------	---	---	-----

1/2" 450-600mm

1/2" EXTENDABLE BREAKER BAR 450-600MM



51479

31,80€

0.65	12	24	1056
------	----	----	------

1/2" 260-410mm

1/2" EXTENDABLE BAR WITH ROUND END



IN 12 UNITS DISPLAY CASE



51805

17,00€

0.33	4	20	640
------	---	----	-----

5 PIECES 1/4" EXTENSION BAR WITH BALL END SET

1/4" 50, 75, 100, 152, 227mm



51447

16,00€

0.34	5	20	960
------	---	----	-----

5 PIECES 1/4" EXTENSION BARS SET

1/4" 50, 75, 100, 152, 227mm



51448

52,00€

2.38	-	5	300
------	---	---	-----

5 PIECES 1/2" EXTENSION BAR WITH BALL END SET

1/2" 50, 125, 250, 380, 510mm



SPARE PARTS AVAILABLE

REF.	mm				€
12995	50	0.03	5	100	7,00€
12996	75	0.04	20	100	7,00€
12997	100	0.06	20	100	7,50€
12998	152	0.08	5	100	9,00€
12999	227	0.11	5	100	9,50€

SPARE PARTS AVAILABLE

REF.	mm				€
14026	50	0.03	10	100	5,50€
14027	75	0.04	-	50	5,60€
10264	100	0.05	10	100	2,00€
14029	152	0.07	-	50	8,50€
14030	227	0.11	-	50	9,50€

SPARE PARTS AVAILABLE

REF.	mm				€
14978	50	0.10	5	100	7,50€
14979	125	0.20	5	50	9,00€
14980	250	0.40	5	25	13,00€
14981	380	0.60	5	20	22,50€
14982	510	0.60	5	10	27,50€

54302

11,50€

0.45	10	40	650
------	----	----	-----

SET OF 6 PRECISION SCREWDRIVERS

6 PCS CrV

x3 PH00, PH0, PH1
x3 SL2, SL3, SL4



HAND TOOLS

52500

19,00€



8 PIECES PRECISION SCREWDRIVER SET SHORT SHAFT

8 PCS



IT CONTAINS

- ⊕ x3 PH00x25, PH0x25, PH1x25
- ⊖ x5 SL0.4x2x25, SL0.4x2.5x25, SL0.5x3x.25, SL0.5x3.5x25, SL0.8x4x25

53917

9,00€

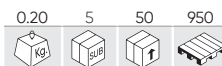

7 PIECES PRECISION SCREWDRIVER SET LONG SHAFT

7 PCS



IT CONTAINS

- ⊕ x3 PH00, PH0, PH1
- ⊖ x4 SL.1.4, SL2.0, SL.2.4, SL3.0

53694

18,40€

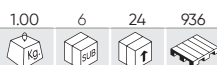

8 PIECES 1/2" IMPACT SCREWDRIVER SET

8 PCS CrV 1/2"



IT CONTAINS

- ⊕ x1 1/2"
- ⊖ x1 1/2" - 8mm
- ⊕ x3 PH 2x36mm, 3x36mm, 3x70mm
- ⊖ x3 SL 7x36mm, 8x36mm, 8x70mm

54126

39,00€



HAMMER CAP SCREWDRIVER SET

12 PCS GO-THROUGH



IT CONTAINS

- ⊕ x6 PH0x75mm, PH1x75mm, PH2x38mm, PH2x100mm, PH3x125mm, PH4x200mm
- ⊖ x6 SL3.2x75mm, SL5x75mm, SL6x38mm, SL6x100mm, SL8x150mm, SL9.5x200mm

53010

18,00€

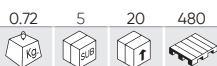

SCREWDRIVER SET WITH INTERCHANGEABLE HANDLE 20 IN 1

11 PCS



IT CONTAINS

- ⊕ x2 PH1, PH2
- ⊖ x2 4x6, 5x7mm
- ⊕ x3 T10x15, T20x25, T30x40
- ⊖ x3 H4x4mm, H5x5mm, H6x6mm
- x1

50902

13,00€



4 UNITS FLAT SCREWDRIVER HAMMER HEAD SET

4 PCS 3", 4", 6", 8"



SCREWDRIVER EVA TRAY - CARBON FINISH

53943

21,50€

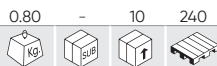

- ⊕ PH4x200, PH3x150, PH2x100, PH2x38, PH1x80, PH0x120, PH1x100

53944

19,50€

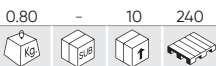

- ⊖ SL9x200, SL4x125, SL5x100, SL5x80, SL6x38, SL6x100, SL8x150mm

53945

18,90€

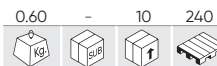

- ⊕ T8x75, T9x75, T10x75, T15x75, T20x75, T25x100, T27x100

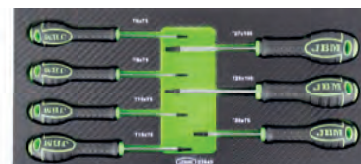
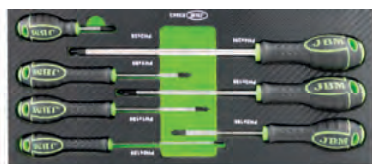

54060 6,00€

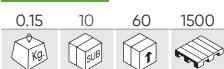

REVERSIBLE DOUBLE END SCREWDRIVER 6X150MM



54061 6,00€



REVERSIBLE DOUBLE END SCREWDRIVER 6X100MM

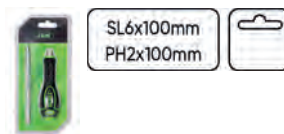

54071 26,50€



6 PIECES GO-THROUGH SCREWDRIVER SET (3 PHILIPS + 3 FLAT)



IT CONTAINS

- ⊕ x3 PH3x150, PH2x100, PH1x75mm
- ⊖ x3 SL8x150, SL6.5x100, SL5.5x75mm

54070 18,00€

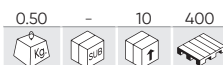

6 PIECES SCREWDRIVER SET (2 PHILIPS + 4 FLAT)



IT CONTAINS

- ⊕ x2 PH1x80, PH2x100mm
- ⊖ x4 SL6.5x150, SL5.5x125, SL4x100, SL3x80mm

52170 16,00€

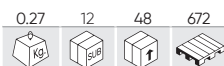

FLEXIBLE SCREWDRIVER

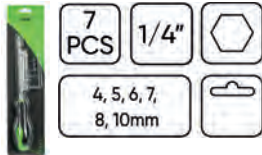

52169 25,00€



3 PIECES FLEXIBLE SCREWDRIVER SET



53575 16,00€



LONG FLEXIBLE SCREWDRIVER



- x3 1/4" 4 mm
- 5 mm
- 7 mm

HAND TOOLS

53225

3,50€

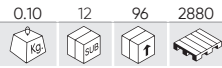

MAGNETIZER/DEMAGNETIZER



51812

46,00€

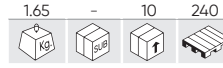

5 PIECES PLIER SET



IT CONTAINS

A	x1	160mm
B	x1	160mm
C	x1	180mm
D	x1	200mm
E	x1	250mm

STRAIGHT NOSE INTERNAL CIRCLIP PLIER



INTERNAL

REF.	DESCRIPTION					€
51018	7" 180mm	0.14	5	100	1800	7,05€
52964	9" 225mm	0.23	6	60	1440	9,45€
53549	13" 330mm	0.45	5	30	-	14,30€



EXTERNAL

REF.	DESCRIPTION					€
51017	7" 180mm	0.17	5	100	1800	6,80€
52966	9" 225mm	0.28	6	60	1800	9,45€
53547	13" 330mm	0.50	5	30	-	14,70€



CIRCLIP PLIER - 90 DEGREE BEND



INTERNAL

REF.	DESCRIPTION					€
51021	7" 180mm	0.16	5	100	-	7,05€
52965	9" 225mm	0.24	6	60	1440	9,20€
53550	13" 330mm	0.45	5	30	-	14,70€



EXTERNAL

REF.	DESCRIPTION					€
51020	7" 180mm	0.13	5	100	1600	6,65€
52967	9" 225mm	0.24	6	60	1440	9,40€
53548	13" 330mm	0.50	5	30	-	15,60€



SIDE CUTTER PLIER

REF.	DESCRIPTION					€
53905	6" 160mm	0.20	6	60	1440	7,30€
53906	7" 180mm	0.20	6	60	1560	8,65€



LONG NOSE PLIERS

REF.	DESCRIPTION					€
53908	6" 160mm	0.15	6	60	1440	7,25€
53909	8" 200mm	0.20	6	60	1440	9,70€



COMBINATION PLIER

REF.	DESCRIPTION						€
53911	6" 160mm	0.20	6	60	1440		8,80€
53967	8" 200mm	0.30	6	60	1440		10,20€
54015	7" 180mm	0.20	6	60	1920		10,20€



15454

35,40€

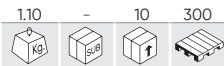

8"

4 PIECES 8" CIRCLIP PLIER SET

REF.	DESCRIPTION						€
10526	8" INTERNAL CIRCLIP PLIERS (STRAIGHT TIPS)	0.21	5	50	-		10,00€
10642	8" EXTERNAL CIRCLIP PLIERS (STRAIGHT TIPS)	0.22	5	50	-		10,00€
10643	8" INTERNAL CIRCLIP PLIERS (CURVED TIPS)	0.21	5	50	-		10,00€
10644	8" EXTERNAL CIRCLIP PLIERS (BENT TIPS)	0.22	5	50	-		10,00€



53389

31,50€

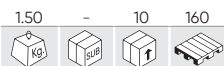

CIRCLIP PLIER SET WITH 16 REPLACEMENT TIPS



WATERPUMP PLIERS

REF.								€
52052	515mm	140mm	1.88	5	10	400		53,00€
50567	250mm	40mm	0.34	10	60	1500		9,60€



52846

37,80€

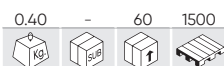

STRAIGHT NOSE EXTRA LONG PLIER

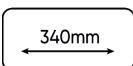

52847

41,00€



45° BENT EXTRA LONG PLIER

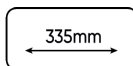

52272

24,60€



3 PIECES LONG REACH PLIER SET 0°, 45°, 90°



HAND TOOLS

53390

34,50€

1.00 10 20 480

HOSE CLAMP PLIERS

MAX 50mm
 630mm



REF.	DESCRIPTION					€
14180	SPARE PARTS SET FOR 53390	0.01	-	100	-	7,90€

51995

24,50€

0.53 5 40 480

HOSE CLAMP PLIERS

630mm
 47mm



REF.	DESCRIPTION					€
14179	SPARE PARTS SET FOR 51995	0.01	-	100	-	8,50€

53396

18,30€

0.50 5 50 450

EXHAUST PIPE CLAMP PLIERS

310mm



52791

18,00€

0.25 5 50 1500

HOSE CLAMP PLIERS CLIC-R

175mm



54376

12,00€

0.20 5 20 540

CV JOINT BANDING TOOL WITH CUTTER

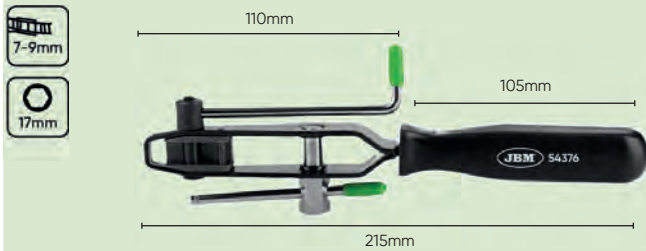

54311

13,00€

0.30 5 20 880

CV JOINT BOOT CLAMP PLIERS

0,55 Kg
 33mm



54330

12,50€

0.40 10 40 -

VALVE STEM SEAL PLIERS

280mm
 OPEL, VW, FORD



54279

6,00€

0.50 5 50 2800

BULB REMOVAL PLIERS



54479

36,50€

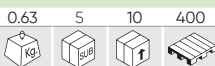

N

PLIERS FOR SELF LOCKING METAL BANDS



52412

5,00€

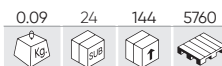

9-IN-1 MULTI TOOL 105MM

CONTAINS

- x2 Screwdriver
- x1 Phillips screwdriver
- x1 Can opener
- x1 Bottle opener
- x1 25mm lime
- x1 Saw with tape 40mm
- x1 Drop point blade 40mm



52050

98,00€



7 PIECE HOSE CLAMP PLIER SET

SPARE PARTS AVAILABLE

REF.	DESCRIPTION	Kg	Sub	Units	€
A 13707	SWIVEL JAW SPRING WIRE CLIP PLIERS	0.25	10	40	14,00€
B 13708	SWIVEL JAW BAND CLIP PLIERS	0.24	6	48	14,00€
C 13709	FLAT BAND CLIP PLIERS	0.24	6	48 576	14,00€
D 13710	45° CIRCLIP PLIERS	0.70	6	48 1536	14,00€
E 13712	HOSE REMOVER PLIERS	0.21	10	40	14,00€
F 51995	HOSE CLAMP PLIERS	0.53	5	40 480	24,50€
G 52791	HOSE CLAMP PLIERS CLIC-R	0.25	5	50 1500	18,00€



52619

23,10€

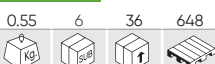

CLIC-R COLLAR PLIERS



Holes of 1/2" on the handles to use as keys
Opening: 0-20mm



52812

65,00€



CV JOINT BOOT CAMP PLIERS



3/8" Female socket for tightening with ratchet.
Max. clamping width: 34mm



53487

16,70€



FUEL LINE PLIERS



52508

38,40€



HOSE CLIP PLIER



LOCKING TAB

52509

36,20€



HAND TOOLS

52625

9,00€

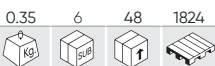

BRAKE SHOE SPRING PLIERS



51355

19,00€

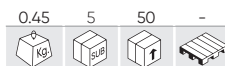

WHEEL WEIGHT PLIERS



52982

53,00€



3 PIECES EXTRA-LONG LOCKING PLIERS SET



53445

17,10€

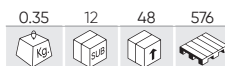

FUEL LINE DISCONNECT PLIER SET



- x1 ■ 5/16" ∅ 8mm
- x1 ■ 3/8" ∅ 10mm
- x1 ■ SPECIAL APPLICATION



51972

12,00€

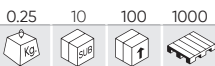

AUTOMATIC SELF ADJUSTING WIRE STRIPPER



52152

13,50€

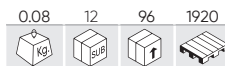

CABLE CUTTER SCISSORS

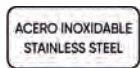

ACERO INOXIDABLE
STAINLESS STEEL

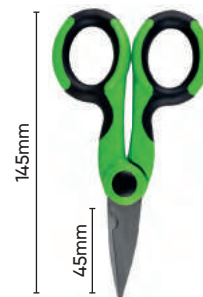

53411

5,00€

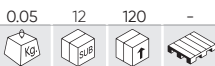

MINI WIRE CUTTER



53412

4,00€

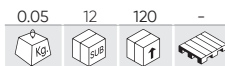

MINI WIRE CUTTER



HEAVY DUTY CABLE CUTTER

REF.	DESCRIPTION					€
53602	360mm - Ø 125mm ²	0.60	-	5	300	30,50€
53603	550mm - Ø 250mm ²	1.75	-	5	300	45,00€
53604	800mm - Ø 500mm ²	3.70	-	5	120	118,00€



BOLT CUTTER

REF.	DESCRIPTION					€
52955	12" - 300mm	0.77	-	20	200	19,80€
52956	14" - 350mm	0.95	-	20	200	19,60€
52957	18" - 450mm	1.47	-	10	360	23,80€
52958	24" - 600mm	2.40	-	8	210	28,20€
52959	30" - 750mm	3.78	-	5	100	42,00€
52960	36" - 900mm	5.15	-	5	105	46,00€



53385 19,30€

0.15	6	54	1026
------	---	----	------



TRIM CLIP REMOVER



53976 9,00€

0.20	6	60	1440
------	---	----	------



LONG NOSE PLIER 6" - 160MM



52761 8,00€

0.25	12	72	1800
------	----	----	------



CRIMPING TOOL FOR INSULATED AND NON-INSULATED TERMINALS 9"

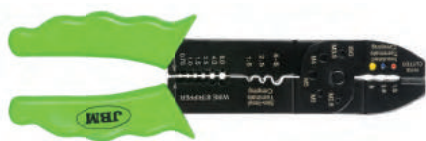

53932 8,00€

0.25	12	72	1296
------	----	----	------



CRIMPING TOOL FOR INSULATED AND NON-INSULATED TERMINALS 9"



52762 9,00€

0.25	12	72	1800
------	----	----	------



CRIMPING TOOL FOR NON-INSULATED TERMINALS 8-3/4"

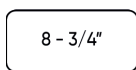

16111 19,20€

0.61	-	10	200
------	---	----	-----



WIRE STRIPPER + TERMINAL EVA TRAY FOR CABINET



HAND TOOLS

54254

43,00€

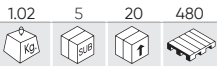

CRIMPING PLIER RATCHET SET WITH 4 JAWS

7
PCS

CONTAINS

- 9" pliers
- 0.15-6mm^o tip
- 10-35mm^o tip
- 0.5-6mm^o tip
- 0.5-10mm^o tip
- 0.5,4mm^o bit
- Screwdriver PH2x150



54112

18,00€

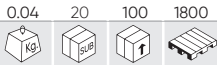

TERMINAL EXTRACTOR WITH 6 CONNECTORS

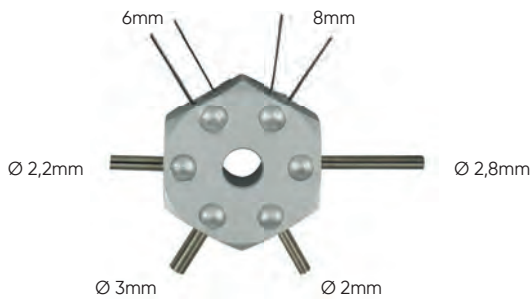

54142

15,20€



NON-MARRING HOOK, PICK AND PRY BAR SET (6 PCS)

6
PCS

CONTAINS

- 2 hook tips
- 2 straight tips
- 2 angled tips
- 6 tips with levers



FLEXIBLE PICK-UP TOOL

REF.	DESCRIPTION	Ø	—					€
51525	FLEXIBLE MAGNETIC PICK-UP TOOL	A	7mm	500mm	0.14	10	60 960	9,80€
51526	FLEXIBLE 4-CLAW PICK-UP TOOL	B	20mm	500mm	0.10	12	144 2016	9,80€
52473	FLEXIBLE MAGNETIC PICK-UP TOOL WITH LED	C	15mm	545mm	0.18	10	60 960	9,90€

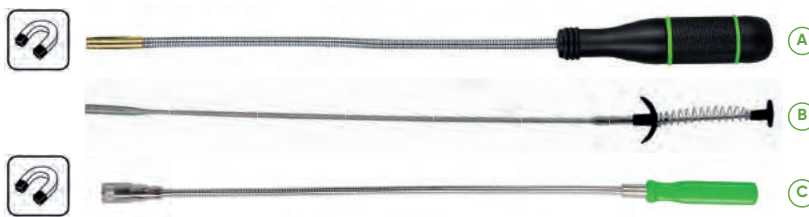

INSPECTION TOOLS

REF.	DESCRIPTION	Ø	—					€
51272	MAGNETIC PICK-UP TOOL WITH LED	A	18mm	90-810mm	0.05	12	72 1512	7,50€
52472	TELESCOPIC MAGNETIC PICK-UP TOOL	B	10mm	135-600mm	0.15	12	108 4320	4,90€
52468	TELESCOPIC INSPECTION MIRROR	C	50mm	280-445mm	0.09	12	48 1536	5,90€



15706

31,00€

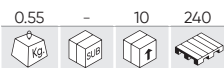

5 PIECES MAGNETIC PICK-UP TOOL SET



15799

28,30€

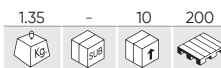

ASSORTED HAMMERS - EVA CARBON FIBRE MODULE



SLEDGE HAMMER FIBREGLASS SHAFT

REF.	DESCRIPTION					€
52182	2Kg - 297mm	2.20	6	12	504	24,00€
52184	4Kg - 880mm	4.31	-	4	128	43,00€
52185	6Kg - 895mm	6.97	-	4	72	55,00€
52186	8Kg - 900mm	8.68	-	2	72	72,00€



SOFT FACED HAMMER - NYLON HEAD

REF.	DESCRIPTION					€
52425	Ø 40mm	0.70	6	12	768	33,30€
52426	Ø 60mm	1.50	2	12	288	52,00€
52427	Ø 70mm	2.02	2	12	204	64,00€



REPLACEMENT HEAD

REF.	mm					€	REF.	mm					€	REF.	mm					€
11212	Ø 40	0.02	5	100	-	5,00€	11213	Ø 60	0.08	5	50	-	10,60€	11214	Ø 70	0.11	5	50	-	12,50€



LOCKSMITH HAMMER

REF.	DESCRIPTION					€
51674	505g	0.60	6	36	864	7,75€
52565	1000g	1.13	6	24	720	11,50€



BALL-PEIN HAMMER

REF.	DESCRIPTION					€
51504	454g	0.55	4	40	800	8,50€
51918	1000g	1.25	6	18	648	12,50€



DEAD BLOW HAMMER

REF.	DESCRIPTION					€
52180	1,35Kg - 355mm	1.45	6	12	432	19,00€
52181	1,80Kg - 370mm	1.81	6	12	300	22,50€
52183	2,20Kg - 405mm	2.30	6	12	288	26,20€



AXE

REF.	DESCRIPTION					€
52188	360mm	0.82	4	24	875	15,50€
52460	410mm	1.17	4	24	864	16,60€
52461	700mm	2.00	4	12	240	25,70€



HAND TOOLS

52830

24,00€

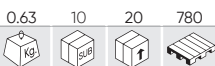

HACKSAW WITH ERGONOMIC HANDLE



IN 10 UNITS
DISPLAY CASE

52831

18,00€

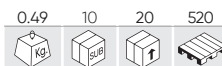

HACKSAW



IN 10 UNITS
DISPLAY CASE

REF. DESCRIPTION

12060 BLADE FOR HACKSAW FOR REF.52830 + 52831 + 51675

				€
0.02	100	800	-	2,50€

53591

5,50€

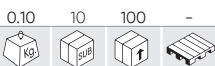

CABLE STRIPPING KNIFE

- Cutting range: 8-28mm.
- Product length: 170mm.
- Blade length: 20mm.
- Hook depth: 5mm.



52786

14,60€

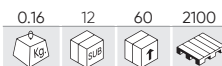

FOLDING KNIFE WITH SEATBELT CUTTER AND WINDOW BREAKING HAMMER



IN 12 UNITS
DISPLAY CASE

TUBE CUTTER

REF.	DESCRIPTION					€
52878	3-32mm	0.22	10	50	1500	11,20€
52879	3-35mm	0.24	10	50	1500	10,10€
52877	Ø MAX: 42mm	0.43	6	48	624	15,80€
53517	Ø MAX: 30mm	0.13	10	60	600	9,50€



52885

18,00€

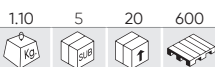

12 PIECE HOLLOW PUNCH SET - METRIC



3, 4, 5, 6, 7, 8, 9, 10,
12, 14, 16, 19mm



54331

27,00€

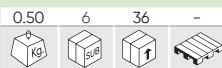

N

SET OF 3 PROFESSIONAL CUTTERS



	BLADE	BLADE SIZE	LENGTH	WEIGHT
A	x4	60x19mm	175mm	115,5g
B	x1	100x10mm	160mm	129,7g
C	x4	60x19mm	175mm	115,5g



SPARE PARTS AVAILABLE

REF.	DESCRIPTION	kg	6	36	€
16342	SET OF 10 CUTTING BLADES FOR REF.54331	0.01	10	100	2,50€
16343	SET OF 10 TRAPEZOID CUTTING BLADES FOR REF.54331	0.01	10	100	2,50€

51909

2,46€

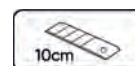
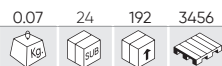

PROFESSIONAL CUTTER



SPARE PARTS AVAILABLE

REF.	DESCRIPTION	kg	6	36	€
16642	SET OF 10 CUTTING BLADES FOR REF.51909	0.01	10	100	1,00€

CHISEL WITH HAND GRIP

REF.	DESCRIPTION	kg	6	36	€	
53120	150mm	0.35	6	24	1200	6,00€
53121	250mm	0.55	6	24	864	7,35€
53122	350mm	0.90	6	12	720	9,50€



ACERO 45C

53083

64,00€

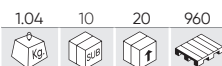

4 PIECES CHISEL SET

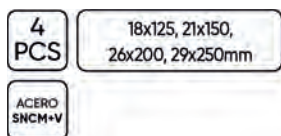

54089

17,50€



5 PIECES LONG COLD CHISEL SET

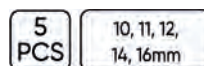

SPARE PARTS AVAILABLE

REF.	mm	kg	6	36	€
15783	155x10	0.09	6	24	3,50€
15784	155x11	0.09	6	24	3,50€
15785	155x12	0.09	6	24	3,50€
15786	155x14	0.09	6	24	3,50€
15787	155x16	0.09	6	24	3,50€



HAND TOOLS

53095

20,50€

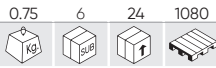

6 PIECES PARALLEL PIN PUNCH SET



54099

13,80€

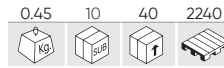

5 PIECES PARALLEL PIN PUNCH SET

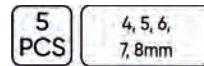

15737

45,00€

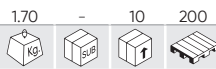

CHISEL AND PIN PUNCH SET

9 PCS

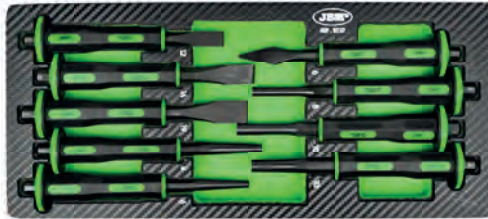

52049

14,00€

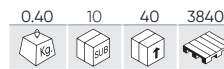

CENTER PUNCH SET



13667

17,60€

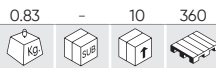

RIVETING PLIERS EVA TRAY FOR CABINET



53993

77,00€

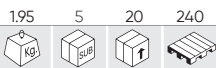

SWIVEL HEAD HAND RIVETER

- 360° rotating head
- Compact, makes it easy to work in small spaces
- One-handed design

CONTAINS

- Standard rivet nose bits 2.4mm (3/32") - 3.2mm (1/8") - 4.0mm (5/32") - 4.8mm (3/16")
- Punches for rivet nuts M3x0.5 - M4x0.7 - M5x0.8 - M6x1
- Punches for rivets M6x1 - M5x0.8 - M4x0.7
- 3 wrenches of 5,5x8,5mm - 12x17mm - 15x19mm
- Spindle holder M6x1 - M5x0.8 - M4x0.7 - M3x0.5



52596

114,00€

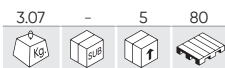

TWO-HANDED RIVET NUT GUN 400MM / 16"



52597

146,00€



AUTOMATIC RIVET NUT GUN 440MM / 17"



SPARE PART FOR 52595, 52596, 52597

REF.	DESCRIPTION				€
13226	M3	0.03	-	100	4,50€
13227	M4	0.04	20	100	4,50€
13228	M5	0.04	20	100	4,50€
13229	M6	0.04	20	100	4,50€

REF.	DESCRIPTION				€
13230	M8	0.04	20	100	4,50€
13231	M10	0.05	-	100	4,50€
13232	M12	0.05	-	100	4,50€



52463

26,10€

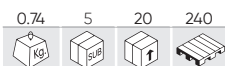

TWO-HANDED RIVETER 300MM / 12"



52464

42,00€



TWO-HANDED RIVETER 400MM/16"

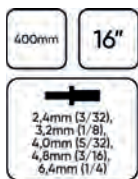

53331

31,80€

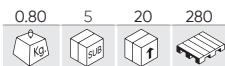

QUICK ACTION HAND RIVETER 10" 250MM

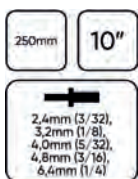

53332

34,50€

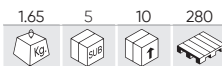

LAZY TONG RIVETER 8" 200MM



HAND TOOLS

52595

64,00€



NUT RIVETER KIT 200MM / 8"

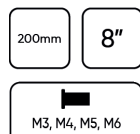

52462

25,30€



COMPACT RIVETER 200MM / 8"



52609

29,00€

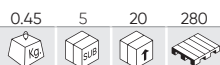

RIVETER + PLASTIC RIVET CASE

Ø 6,6mm x 17,2mm (10u.)
Ø 6,3mm x 25,2mm (10u.)
Ø 5mm x 17,2mm (10u.)
Ø 5mm x 15,8mm (10u.)



SPARE PARTS AVAILABLE

REF.	Ø					€
13674	6x19,3mm	0.04	25	2500	0,50€	
13675	6x17,8mm	0.01	25	500	0,50€	
13676	6x25,5mm	0.01	100	1000	0,50€	
13677	6x24,5mm	0.03	25	1000	0,50€	
13678	6x24mm	0.01	25	1000	0,50€	

52575

119,00€

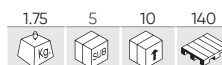

AIR RIVETER



- Traction: 1586LBS / 720 KGS.
- Length: 9/16" - 14MM.
- Max. 60FT IB / 23-69NM.
- Air consumption: 0.03CFM/0.86L/MIN.
- Air inlet size: 1/4".

CONTAINS

- O-Rings
- Safety cup to collect
- Spent rivets
- 2 Multi-tools
- Quick hitch



LEVEL

ALUMINIUM

REF.	DESCRIPTION					€
53613	500mm	0.55	5	30	1260	19,50€
53614	600mm	0.60	5	30	840	21,50€
53615	800mm	0.85	5	20	600	34,60€



MAGNETIC TUBULAR

REF.	DESCRIPTION					€
53616	500mm	0.30	5	60	1260	10,40€
53617	600mm	0.30	5	60	840	9,25€
53618	800mm	0.35	5	30	600	13,90€

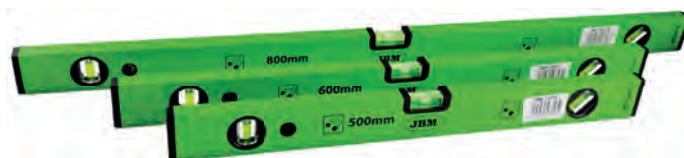

LEVEL DISPLAY

REF.					€
14183	0.80	-	10	-	31,00€



MEASURING TAPE

REF.	DESCRIPTION					€
53025	3m x 16mm	0.13	12	48	2016	3,50€
53026	5m x 25mm	0.26	12	48	2016	5,80€
53027	7,5m x 25mm	0.40	12	48	1500	9,00€



IN 12 UNITS DISPLAY CASE

52433 4,80€

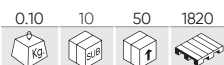

20 METRIC BLADE FEELER GAUGE 0.05-1.0 MM

0,05-1mm



52638 9,95€

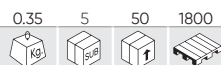

LEATHER PUNCH PLIERS

Ø 2, 2.5, 3, 3.5, 4, 4.5mm



52318 73,00€



MAGNETIC CAMBER GAUGE

-6° / +6°



52904

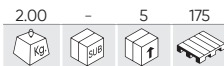

DIAL TEST INDICATOR GAUGE SET

REF.	DESCRIPTION					€
13704	DEPTH GAUGE FOR REF. 52904	0.10	-	50	1500	21,00€



61,00€

VERNIER CALIPER

REF.				€
50724	0.30	5	50	28,00€
50937	0.24	10	50	10,50€



150mm

50724 DIGITAL

50937 VERNIER

TYRE TREAD DEPTH GAUGE

REF.				€
52873	0.04	5	300	11,00€
53042	0.05	10	100	9,90€



52873 VERNIER

53042 DIGITAL

TORQUE ANGLE GAUGE

REF.				€
52583	0.20	4	48	8,50€
52794	0.48	6	24	28,00€



52583

52794 MAGNETIC

HAND TOOLS

51951

15,60€

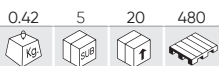

3 PIECES STEEL SCRAPER SET



53339

9,50€

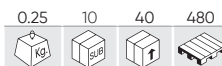

4 PIECES BODY FILLER APPLICATOR SET



53589

12,00€

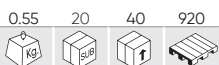

HEAVY DUTY STAPLER



STAPLES HEIGHT: 4-14mm



52700

20,50€

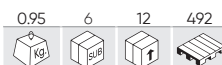

FLARING TOOL / PIPE BENDER / TUBE KIT

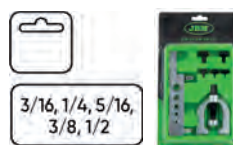

REF.	DESCRIPTION					€
14167	1000 PCS STAPLE PACK FOR REF.53589 (11.3X0.7X8MM)	0.10	50	100	-	2,50€

51853

18,00€



SET OF 5 STEEL FILES

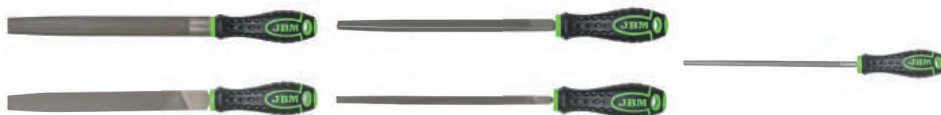

52760

4,10€



BRUSHES



52515

9,10€



BRUSHES



52905

28,00€



6-8-10 MM TUBE BENDER



MARKED DEGREES

ALUMINIUM, COPPER AND STEEL TUBES

WORKSHOP FURNITURE

- 72 TOOL TROLLEYS
- 83 TOOL SETS
- 90 ACCESSORIES FOR TROLLEY
- 93 WORK BENCHES
- 95 STORAGE
- 99 STOOLS / MECHANIC CREEPER
- 100 VICES/ANVILS



54327

2.788,00€

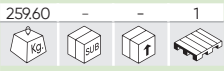

N

WORKSHOP MODULAR STORAGE SYSTEM (18 PCS)



MOBILE 6 TOOL TROLLEY WITH 6 DRAWERS WITH A RUBBER MAT

TOLL TROLLEY MEASURES

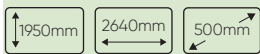

SQUARE HITCH

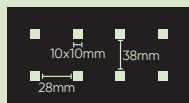

SPECIFIC MEASURES

	A	B	C	D	E	F	G
HEIGHT	1890mm	340mm	340mm	38mm	900-950mm	750-880mm	900-950mm
LENGTH	600mm	680mm	680mm	2040mm	680mm	666mm	680mm
WIDTH	500mm	280mm	25mm	500mm	500mm	460mm	500mm

INNER MEASURES

	A1	B1	E1	E2	E3	F1	F2	G1
HEIGHT	1890mm	340mm	58mm	136mm	216mm	58mm	137mm	715mm
LENGTH	600mm	680mm	567mm	567mm	567mm	567mm	567mm	596mm
WIDTH	500mm	280mm	408mm	408mm	408mm	408mm	408mm	475mm

TOOL PANELS ARE COMPATIBLE WITH OUR HOOKS: REF.16354, 16355, 16356, 16357

WORKSHOP FURNITURE

TOOL TROLLEY WITH 12 DRAWERS

53939 1.280,00€

98.70 - 1 4

FULL
172 PCS

INNER MEASURES 1ST COLUMN

A SMALL DRAWERS (X4)



B MEDIUM DRAWERS (X1)



C BIG DRAWER (X1)



TOLL TROLLEY MEASURES



53868 1.090,00€

83.50 - 1 4

EMPTY
172 PCS

INNER MEASURES 2ND COLUMN

D SMALL DRAWERS (X4)



E MEDIUM DRAWERS (X1)



F BIG DRAWER (X1)



SQUARE HITCH

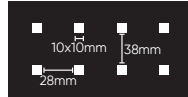

EVA TOOL SETS:

53708 325,00€

15.20 - 1 20

4 TRAY EVA TRAY IN CARBON FIBER FINISH SET

IT CONTAINS

REF.	Box	Box	Box	€
14296	6.05	4	80	118,00€
14297	3.30	4	96	87,00€
14298	2.10	4	96	51,50€
14299	3.25	4	96	87,00€

14296



SPARE PARTS AVAILABLE



14297



SPARE PARTS AVAILABLE

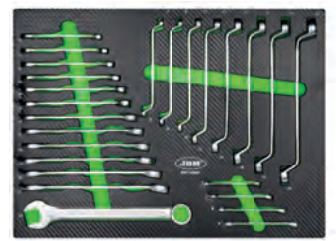

14298



SPARE PARTS AVAILABLE



14299



SPARE PARTS AVAILABLE



FOR FURTHER INFORMATION

PAGE 83

TOOL TROLLEY WITH 7 DRAWERS XL

53912 1.280,00€

74.50 - - 4

FULL

199 PCS XL

53869 990,00€

74.50 - 1 4

EMPTY

199 PCS XL

53913 1.280,00€

74.50 - - 4

FULL

199 PCS XL

53870 990,00€

74.50 - 1 4

EMPTY

199 PCS XL



INNER MEASURES

SMALL DRAWERS (X5)

74mm 705mm 400mm 25Kg

BIG DRAWERS (X2)

151,5mm 705mm 400mm 35Kg

SQUARE HITCH

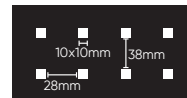

TOLL TROLLEY MEASURES

984mm 980mm 510mm



EVA TOOL SETS:

IT CONTAINS

REF.				€
14296	6.05	4	80	118,00€
14297	3.30	4	96	87,00€

REF.				€
14298	2.10	4	96	51,50€
14299	3.25	4	96	87,00€

REF.				€
15122	1.70	10	200	74,00€
15155	2.45	10	180	59,00€

REF.				€
15161	2.10	10	180	62,00€
15514	0.05	10	360	9,35€

14296

SPARE PARTS AVAILABLE

15122

SPARE PARTS AVAILABLE

14297

SPARE PARTS AVAILABLE

15161

SPARE PARTS AVAILABLE

14298

SPARE PARTS AVAILABLE

15155

SPARE PARTS AVAILABLE

14299

SPARE PARTS AVAILABLE

15514

7 DRAWER TOOL TROLLEY - GREEN

172 PCS 300Kg

N

54389 790,00€

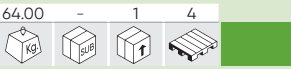

FULL

54503 490,00€

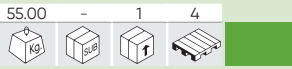

EMPTY

INNER MEASURES

SMALL DRAWERS (X5)



BIG DRAWERS (X2)

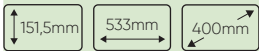

DRAWER LOADING CAPACITY: 35KG.
TOTAL LOADING CAPACITY: 300KG.

TOLL TROLLEY MEASURES



SQUARE HITCH

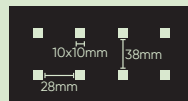

EVA TOOL SETS:

53708

325,00€

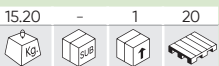

4 TRAY EVA TRAY IN CARBON FIBER FINISH SET

IT CONTAINS

REF.	Kg	Sub	Qty	Price
14296	6.05	4	80	118,00€
14297	3.30	4	96	87,00€
14298	2.10	4	96	51,50€
14299	3.25	4	96	87,00€

14296



SPARE PARTS AVAILABLE



14297



SPARE PARTS AVAILABLE

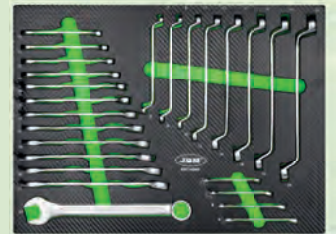

14298



SPARE PARTS AVAILABLE



14299



SPARE PARTS AVAILABLE



FOR FURTHER INFORMATION

PAGE 83

TOOL TROLLEY WITH 7 DRAWERS

53661 790,00€

65.50 - 1 4

FULL

53761 490,00€

52.50 - 1 4

EMPTY

53767 790,00€

56.00 - 1 4

FULL

53768 490,00€

56.00 - 1 4

EMPTY

53686 790,00€

65.00 - 1 4

FULL

53762 490,00€

55.50 - 1 4

EMPTY

53904 790,00€

65.00 - 1 4

FULL

54006 490,00€

55.00 - 1 4

EMPTY

INNER MEASURES

SMALL DRAWERS (X5)



BIG DRAWERS (X2)



DRAWER LOADING CAPACITY: 30KG.
TOTAL LOADING CAPACITY: 70KG.

TOLL TROLLEY MEASURES



SQUARE HITCH

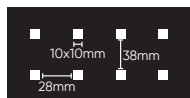

172 PCS 280Kg



EVA TOOL SETS:

53708 325,00€

15.20 - 1 20

4 TRAY EVA TRAY IN CARBON FIBER FINISH SET

IT CONTAINS

REF.	Kg	Box	Tray	€
14296	6.05	4	80	118,00€
14297	3.30	4	96	87,00€
14298	2.10	4	96	51,50€
14299	3.25	4	96	87,00€

14296



SPARE PARTS AVAILABLE



14297



SPARE PARTS AVAILABLE



14298



SPARE PARTS AVAILABLE



14299



SPARE PARTS AVAILABLE



FOR FURTHER INFORMATION

PAGE 83

WORKSHOP FURNITURE

7 DRAWER TOOL TROLLEY - SPECIAL FOR TRUCKS

54240 1.887,00€

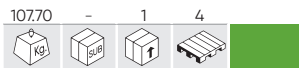

FULL

54237 1.887,00€



FULL

54238 1.887,00€

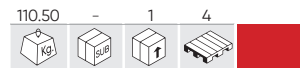

FULL

54239 1.887,00€

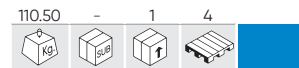

FULL

INNER MEASURES

SMALL DRAWERS (X5)



BIG DRAWERS (X2)



DRAWER LOADING CAPACITY: 30KG.
TOTAL LOADING CAPACITY: 70KG.

TOLL TROLLEY MEASURES



SQUARE HITCH

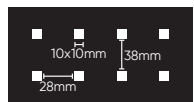

EVA TOOL SETS:

54134

1.415,00€

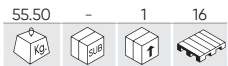

TRUCK REPAIR TOOL SET

IT CONTAINS

REF.	Box	Box	Pallet	€
15730	10.22	2	48	289,00€
15731	5.20	2	48	214,00€

REF.	Box	Box	Pallet	€
15732	6.40	2	48	293,50€
15733	3.55	2	48	113,00€

REF.	Box	Box	Pallet	€
15734	9.40	2	48	288,50€
15735	10.00	2	48	152,00€

REF.	Box	Box	Pallet	€
15736	14.80	2	40	488,50€

15730

SPARE PARTS AVAILABLE

15731

SPARE PARTS AVAILABLE

15732

SPARE PARTS AVAILABLE

15733

SPARE PARTS AVAILABLE

15734

SPARE PARTS AVAILABLE

15735

SPARE PARTS AVAILABLE

15736

SPARE PARTS AVAILABLE

FOR FURTHER INFORMATION
PAGE 84

TOOL TROLLEY WITH 7 DRAWERS - SPECIAL VDE

54236 1.856,00€

67.70 - 1 4

FULL

54233 1.856,00€

67.70 - 1 4

FULL

54234 1.856,00€

67.70 - 1 4

FULL

54235 1.856,00€

67.70 - 1 4

FULL

INNER MEASURES

SMALL DRAWERS (X5)



BIG DRAWERS (X2)



DRAWER LOADING CAPACITY: 30KG.
TOTAL LOADING CAPACITY: 70KG.

TOLL TROLLEY MEASURES



SQUARE HITCH

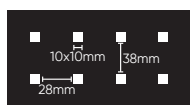

Trolley specifically designed to cover all basic needs derived from maintenance and service of hybrid and fully electric vehicles, as well as for high-tension jobs

24 PCS

CLASS CLASS 0 ENROLLABLE ROLLS

1000V IEC 60900 C



IT CONTAINS

REF.	DESCRIPTION	UNI.					€
52162	LASER THERMOMETER -50°C TO 550°C	1	0.17	6	72	576	38,00€
53940	YELLOW/BLACK PLASTIC POST	4	0.55	-	6	90	13,20€
54326	PLASTIC CHAIN - 7M YELLOW/BLACK	4	0.30	-	20	720	7,30€
53942	PLASTIC S-HOOK	8	0.01	50	5000	75000	0,50€
54093	26 PIECES INSULATED TOOL SET IN EVA TRAY	1	3.25	-	4	80	441,00€
54114	INSULATION TESTER	1	1.48	-	10	100	248,00€
54129	INSULATING MAT CLASS 0	1	0.03	10	50	-	110,00€
54130	INSULATING GLOVES FOR VOLTAGE WORK T.9	1	0.35	-	1	100	58,00€
54132	ELECTRICAL INSULATING FACE SHIELD FOR VOLTAGE WORK	1	0.70	-	1	72	190,00€
54241	INSULATED RESCUE HOOK - 45KV	1	1.10	-	1	50	120,00€

FOR FURTHER INFORMATION

PAGE 345

WORKSHOP FURNITURE

7 DRAWER TOOL TROLLEY - TIMING TOOL SET INCLUDED

53951 1.794,00€

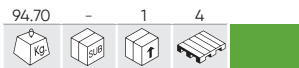

FULL

53952 1.794,00€



FULL

54501 1.794,00€



FULL

54502 1.794,00€

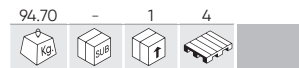

FULL

INNER MEASURES

SMALL DRAWERS (X5)

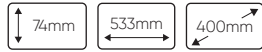

BIG DRAWERS (X2)



DRAWER LOADING CAPACITY: 30KG.
TOTAL LOADING CAPACITY: 70KG.

TOLL TROLLEY MEASURES



SQUARE HITCH

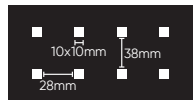

EVA TOOL SETS:

53775

1.109,00€

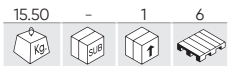

6 PIECES TIMING TOOL SET

IT CONTAINS

REF.	Kg	1	36	€
53769	5.90	3	36	178,00€
53770	6.15	3	36	198,00€

REF.	Kg	3	36	€
53771	4.05	3	36	158,00€
53772	6.40	3	36	229,00€

REF.	Kg	3	36	€
53773	6.60	3	36	298,00€
53774	6.95	3	36	190,00€

FOR FURTHER INFORMATION

PAGE 297



53769



RENAULT / NISSAN / OPEL / VOLVO

53770



FORD / SEAT / VOLKSWAGEN / MAZDA / VOLVO

53771



FIAT / FORD / CITROËN / PEUGEOT

53772



FORD / VAG / MAZDA / VOLVO

53773



FIAT / ALFA / LANCIA / OPEL / SUZUKI / FORD

53774



OPEL / CHEVROLET / SAAB / FIAT / LANCIA / SUZUKI / FORD

54295

500,00€

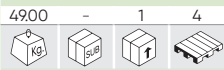

N

7 EQUAL DRAWERS CABINET - GREEN - EMPTY

TOLL TROLLEY MEASURES



SQUARE HITCH

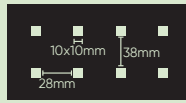

INNER MEASURES



54296

520,00€

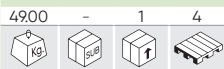

N

8 EQUAL DRAWERS CABINET - GREEN - EMPTY

TOLL TROLLEY MEASURES

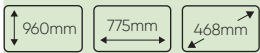

SQUARE HITCH

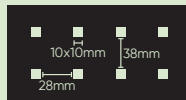

INNER MEASURES

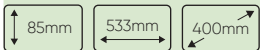

54297

540,00€

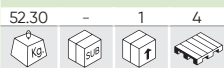

N

9 EQUAL DRAWERS EMPTY CABINET - GREEN - EMPTY

TOLL TROLLEY MEASURES

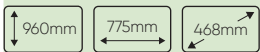

SQUARE HITCH

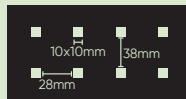

INNER MEASURES

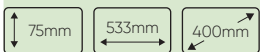

53672

440,00€

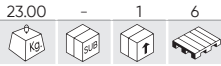

97 PCS

MODULAR TOOL BOX TROLLEY



3 INDEPENDENT MODULES EQUIPPED WITH:



	1/2"	x11	8,10,11,12,13,14,16,17,19,21,22mm
	1/4"	x13	4,4.5,5,5.5,6,7,8,9,10,11,12,13,14mm
	1/2"	x1	
	1/4"	x1	
	1/2"	x2	125,300mm
	1/4"	x2	50,100mm
		x1	180mm
		x1	160mm
		x2	160mm, 180mm
		x2	PH2x125, PH1x100mm
		x2	6x150mm, 5x100mm
		x9	8,9,10,11,12,13,14,17,19mm
		x1	250mm
		x1	300g
		x1	250mm
		x1	200mm
		x8	1,5x8mm
		x1	3mm
	1/4"	x32	
	1/4"	x1	
	1/4"	x1	
	1/4"	x1	
	1/2"	x1	
	1/4"	x1	

A TOOL BOX IN EVA MODULES + REMOVABLE UPPER TRAY

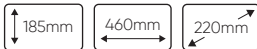

B 2 DRAWERS WITH TOOLS IN EVA MODULES



C FRONT OPENING COMPARTMENT



53867

1.095,00€

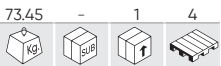

9 DRAWER TOOL TROLLEY WITH ORGANIZERS - GREEN

TOLL TROLLEY MEASURES

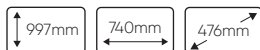

INNER MEASURES



REF.	mm	UNI.			€
15073	174x53mm	21	0.05	200	1,00€
15076	396x53mm	18	0.30	50	3,50€

YOU MAY ALSO LIKE...

REF.	mm			€
15070	67x53mm	0.05	200	0,50€
15071	103x53mm	0.05	200	0,60€
15072	138x53mm	0.05	200	0,70€
15074	210x53mm	0.10	200	1,00€
15075	280x53mm	0.10	200	1,20€



WITH SEPARATORS
FREE ORGANIZATION

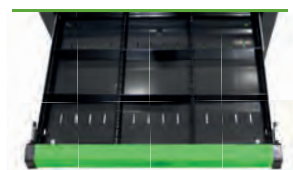

SQUARE HITCH

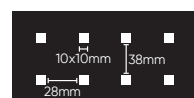



EVA MODULES SET WITH CARBON FIBER FINISH

53708 325,00€

15.20 - 1 20

4 TRAY EVA TRAY IN CARBON FIBER FINISH SET

IT CONTAINS

14296 118,00€

6.05 - 4 80

	1/2" x17	x10, 11, 12, 13, 14, 15, 16, 17, 18, 19, 20, 21, 22, 24, 27, 30, 32mm
	1/4" x13	4, 4.5, 5, 5.5, 6, 7, 8, 9, 10, 11, 12, 13, 14mm
	1/2" x5	14, 15, 17, 19, 22mm
	1/4" x8	6, 7, 8, 9, 10, 11, 12, 13mm
	1/2" x8	E10, E11, E12, E14, E16, E18, E20, E24
	1/4" x5	E4, E5, E6, E7, E8
	7/16" x2	1/2" - 1/4"
	1/2" x2	125, 250mm
	1/4" x2	50, 100mm
	x2	
	1/2" x1	
	1/2" x2	16, 21mm

	x2	PH1, PH2
	x2	PZ1, PZ2
	1/4" x4	3, 4, 5, 6mm
	x3	SL4, SL5.5, SL6.5
	x8	T8, T10, T15, T20, T25, T27, T30
	x2	PH3, PH4
	x2	PZ3, PZ4
	8mm x5	7, 8, 10, 12, 14mm
	x3	SL8, SL10, SL12
	x5	T40, T45, T50, T55, T60
	x1	1/4"
	x1	1/4"
	1/2" x1	8mm
	x3	1.5, 2, 2.5mm

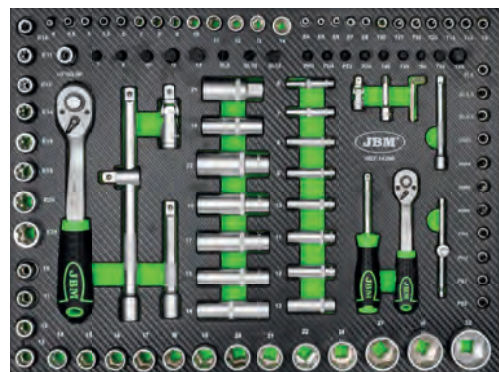

14297 87,00€

3.30 - 4 96

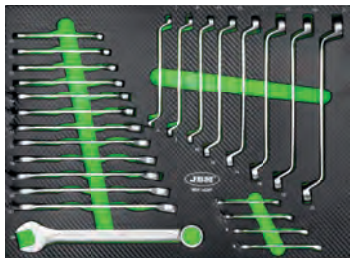

	6x7, 8x9, 10x11, 12x13, 14x15, 16x17, 18x19, 20x22mm
	6, 7, 8, 10, 11, 12, 13, 14, 15, 17, 19, 22mm

14298 51,50€

2.10 - 4 96



	PH0x75, PH1x100, PH2x100, PH3x150, PH4x200
	6, 7, 8, 10, 11, 12, 13, 14, 15, 17, 19, 22mm
	2x38mm
	6x38mm
	1.5, 2, 2.5, 3, 4, 5, 6, 8, 10mm
	10, 15, 20, 25, 27, 30, 40, 45, 50mm

14299 87,00€

3.25 - 4 96



	35mm		8"
	450g		10"
	10"		7.5"
	8"		3m
	8"		

54134

1.415,00€

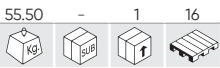

TRUCK REPAIR TOOL SET

IT CONTAINS

15730

289,00€

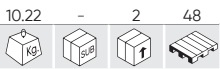

	55mm	H5, H6, H7, H8, H10, H12
	65mm	H14
	70mm	H16, H17, H18, H18, H20
	30mm	H4, H5, H6, H7, H8, H10, H12 T20, T25, T30, T40, T45, T50, T55
	75mm	H4, H5, H6, H7, H8, H10, H12 M5, M6, M8, M10, M12 T20, T25, T30, T40, T45, T50, T55
	1/2"	x9 E10, E11, E12, E14, E16, E18, E20, E22, E24
	1/2"	x10 10, 11, 12, 13, 14, 15, 16, 17, 18, 19mm

	1/2"	x3 50, 125, 250mm
	1/2"	x1 430mm
	1/2"	x1 10mm
	3/4"	x5 21, 24, 27, 34, 36mm
	3/4"	x4 24, 30, 32, 36 mm
		1/2x10, 3/8x10mm
		1/2x10, 3/8x10mm
	3/8"	10mm
	1/4"	300, 380, 450mm
	1/4"	
	1/2"	

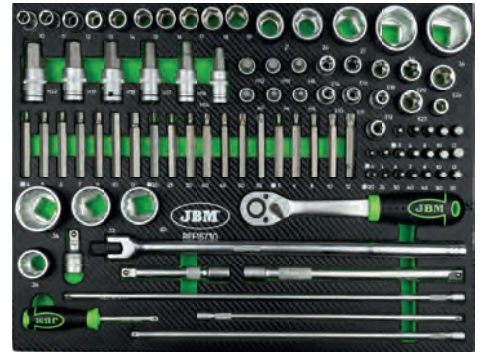

15731

214,00€

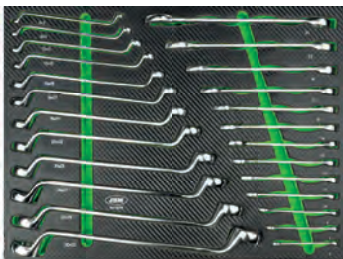
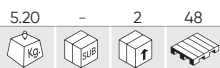

	6x7, 8x9, 10x11, 12x13, 14x15, 16x17, 18x19, 20x22, 21x23, 24x27, 25x28, 30x32mm
	6, 7, 8, 10, 11, 12, 13, 14, 15, 17, 19, 22, 24mm

15732

293,50€

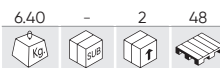

	10, 13, 17mm
	10x11, 12x13, 14x17mm
	E10xE12, E14xE18, E20xE24
	8x10, 11x13, 14x15, 16x17, 18x19mm
	27, 30, 32, 36mm
	10, 13, 17, 19mm

15733

113,00€

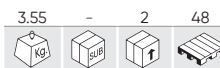

	PH0x75mmL, PH1x75mmL, PH2x100mmL, PH2x38mmL, PH3x150mmL, PH4x200mmL
	SL3.5x75mmL, SL5x75mmL, SL6x100mmL, SL6x38mmL, SL8x150mmL, SL9.5x200mmL
	10x11, 12x13, 14x15mm
	10x11, 12x13, 14x15, 16x17, 18x19mm

15734

288,50€



	1kg
	24, 27, 30, 32, 36, 41mm
	3/4" 500mm
	3/4" 500mm
	1.5, 2, 2.5, 3, 4, 5, 6, 8, 10mm

15735

152,00€

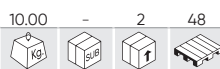

	220mm		250mm
	330mm		6" - 160mm
	330mm		7" - 180mm
	330mm		0°/45°/90°
	330mm		300mm

15736

488,50€



	1/2"	13, 14, 15, 16, 17, 18, 19, 21, 22, 24mm
	3/4"	78mm
	3/4"	22, 24, 27, 30, 32, 33, 36, 38, 46mm
	1/2"	51, 60mm
	1/2"	90mm
	1/2"	T40, T45, T50, T60, T70
	1/2"	78mm H6, H8, H14, H17
	3/4"	100mm T80, T90, T100
	1/2"	40mm M18
	1/2" (M)x3/4"(H)	- 3/4"(M)x1/2"(H)
	1/2"	- 3/4"
		125mm

15681

134,00€

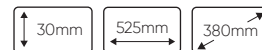
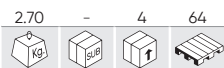

	H3, H4, H5, H6, H7, H8		7, 8, 10, 12, 14mm
	M8, M10, M12		PH3, PH4
	PH0, PH1, PH2, PH3		PZ3, PZ4
	PZ0, PZ1, PZ2, PZ3		8mm
	1/2" SL4, SL5.5, SL6.5, SL7		SL8, SL10, SL12
	T8, T9, T10, T15, T20, T25, T27, T30, T40		T40, T45, T50, T55, T60, T70
	T8, T9, T10, T15, T20, T25, T27, T30, T40		T40, T45, T50, T55, T60, T70
	TS10, TS15, TS20, TS25, TS27, TS30, TS40, TS45, TS50		H7 (230mmL), H10, H11, H13 (140mmL), H14, H17, H19, H22, H24 (55mmL)
	1/2" 8mm		M9 (100mmL), M10, M12, M14 (140mmL), M16 (53mmL), M16 (100mmL)
	3/8" 8mm		1/2" R7, R8 (240mmL), R9 (100mmL), R10 (140mmL)
	1/4" 6mm		T30 (300mmL), T40, T45, T50, T55, T60, T70 (140mmL), T80 (100mmL)
	1/2" M18		HT5 (160mmL)

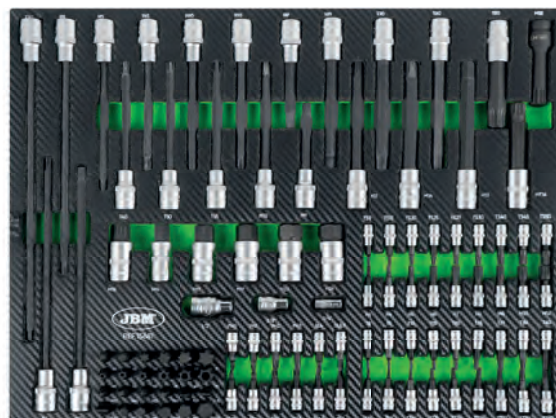

15122 74,00€

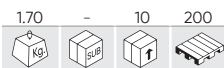

x12 8, 9, 10, 11, 12, 13, 14, 15, 16, 17, 18, 19mm

15155 59,00€

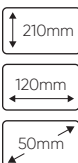
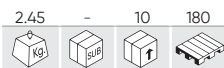

x11 8, 10, 11, 12, 13, 14, 15, 16, 17, 18, 19mm

15156 70,00€

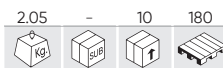

x4 21x23, 24x27, 25x28, 30x32mm

15157 42,00€

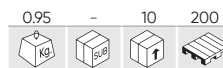

x7 6x8, 10x12, 13x14, 15x17, 19x21, 22x24mm

15158 59,00€

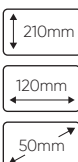
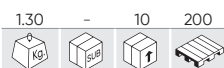

x7 8, 10, 11, 13, 14, 17, 19mm

15159 44,00€

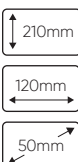
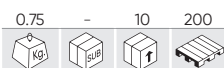

x5 8x10, 11x13, 14x15, 17x19, 20x22mm

15160 42,00€

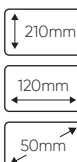
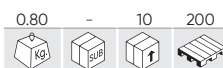

x6 8x9, 10x11, 12x13, 14x15, 16x17, 18x19mm

15161 62,00€

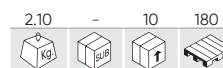

x4 27, 29, 30, 32mm

15316 58,00€

0.85 - 10 260

210mm
120mm
50mm

x3 8, 9, 10, 11, 12, 13, 14, 15, 16, 17, 18, 19mm

53943 21,50€

0.80 - 10 240

210mm
120mm
50mm

x7 PH4x200, PH3x150, PH2x100, PH2x38 PH1x80, PH0x120, PH1x100

53944 19,50€

0.80 - 10 240

210mm
120mm
50mm

x7 SL9x200, SL4x125, SL5x100, SL5x80, SL6x38, SL6x100, SL8x150mm

53945 18,90€

0.60 - 10 240

210mm
120mm
50mm

x7 T8x75, T9x75, T10x75, T15x75, T20x75, T25x100, T27x100

15454 35,40€

1.10 - 10 300

210mm
120mm
50mm

x1 8" x1 8"
x1 8" x1 8"

15541 27,60€

0.95 - 10 220

210mm
120mm
50mm

x1 7" - 180mm
x1 8" - 200mm
x1 8" - 200mm

15706 31,00€

0.55 - 10 240

210mm
120mm
50mm

x1 180 - 770mm x1 280 - 870mm
x1 130 - 640mm x1 170-580mm
x1 495mm

15737 45,00€

1.70 - 10 200

210mm
120mm
50mm

x1 6x180mm
x2 8x180, 10x180mm
x3 6x180, 8x180, 10x180mm
x3 2x160, 16x175, 19x180mm

15315 28,20€

1.05 - 10 260

210mm
120mm
50mm

x1 8" x1 8"
x1 8" x1 8"

15514 9,35€

0.05 - 10 360

210mm
120mm
50mm

EMPTY

54158 38,00€

1.70 - 10 200

210mm
120mm
50mm

3/8" x1 10mm
1/2" x1 10mm
30mm x7 4, 5, 6, 7, 8, 10, 12mm
75mm x7 4, 5, 6, 7, 8, 10, 12mm
30mm x8 T20, T25, T30, T40, T45, T50, T55, T60
75mm x8 T20, T25, T30, T40, T45, T50, T55, T60
30mm x5 M5, M6, M8, M10, M12
15mm x5 M5, M6, M8, M10, M12

15737 45,00€

1.70 - 10 200

210mm
120mm
50mm

x1 6x180mm
x2 8x180, 10x180mm
x3 6x180, 8x180, 10x180mm
x3 2x160, 16x175, 19x180mm

15162 30,20€

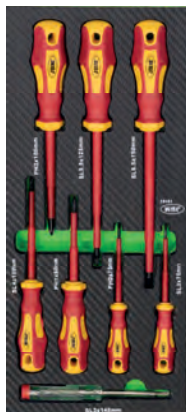
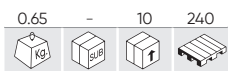

- ⊖ **x4** SL3x75, SL4x100, SL5.5x125, SL6.5x150mm
- ⊕ **x3** PH0x75, PH1x80, PH2x100mm
- ⌵ **x1** 140mm

54093



441,00€



- ⊖ **3/8"** x10 45mm 8, 10, 11, 12, 13, 14, 16, 17, 18, 19, 21, 22mm
- ⊖ **x2** 4x100, 5,5x125mmL
- ⊖ **x2** PH1x80, PH2x100mm
- ⊖ **x1** 185mm
- ⊖ **x1** 52mm
- ⊖ **x1** 185mm
- ⊖ **x6** 7x86, 8x99, 10x109, 12x127, 14x141, 17x156mm
- ⊖ **1/2"** x1 125mm
- ⊖ **3/8"** x1 200mm
- ⊖ **3/8"** x1 200mm

15799 28,30€



- ⌵ **x1** 450g
- ⌵ **x1** 35mm

16111 19,20€

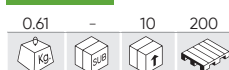

- ⌵ **x1** 220mm
- ⊖ BV1.25 ⊖ BV2
- ⊖ RV2-4 ⊖ RV2-4L
- ⊖ SV2-4 ⊖ SV5.5-6
- ⊖ MDD2-250 ⊖ FDD2-250

51805 17,00€

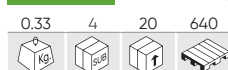

- ⌵ **x5** 50, 75, 100, 152, 227mm

51447 16,00€



- ⌵ **x5** 50, 75, 100, 152, 227mm

51448 52,00€

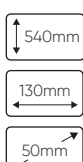

- ⌵ **x5** 50, 125, 250, 380, 510mm

52912 91,00€

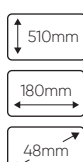

- x6** E6xE7 (200mmL), E8xE10 (235mmL), E11xE12 (290mmL), E14xE16 (370mmL), E18xE20 (410mmL), E22xE24 (420mmL)

54066 83,00€

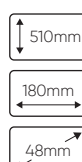

- x7** 8mm (23,5mmL), 10mm (29,3mmL), 12mm (32,8mmL), 13mm (34,9mmL), 14mm (36,7mmL), 17mm (41mmL), 19mm (42mmL)

51864 64,00€

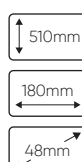

- x6** 10x11mm (290mmL), 12x14mm (330mmL), 13x15mm (368mmL), 16x18mm (407mmL), 17x19mm (407mmL), 22x24mm (430mmL)

WORKSHOP FURNITURE

54032 84,00€

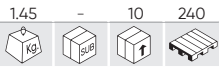

400mm
180mm
50mm



x12 8mm (89mmL), 9mm (94mmL), 10mm (95mmL), 11mm (99mmL), 12mm (102mmL), 13mm (107mmL), 14mm (114mmL), 15mm (117mmL), 16mm (123mmL), 17mm (125mmL), 18mm (130mmL), 19mm (135mmL)

15083 8,50€

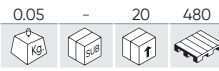

380mm
175mm
50mm



EMPTY

15084 68,00€

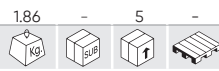

380mm
175mm
50mm

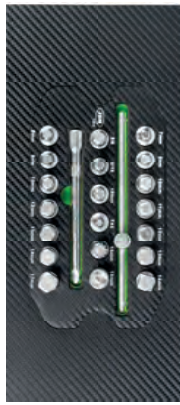

x2 5/16", 3/8"
x7 7, 8, 10, 11, 12, 13, 14mm
x1 10mm
x1 10mm
x7 8, 9, 10, 12, 13, 14, 17mm
x1 T45
x1 M16
x1 200mm
x1 150mm

53979 34,60€

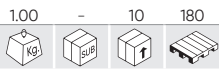

390mm
340mm
50mm

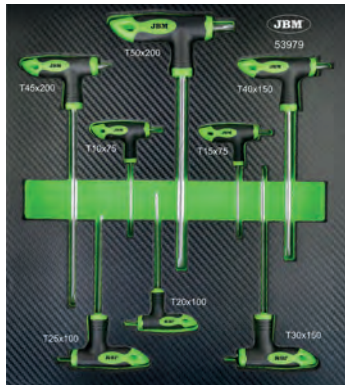

x8 T10x75, T15x75, T20x100, T25x100, T30x150, T40x150, T45x200, T50x200mm

53980 34,60€

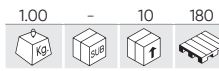

390mm
340mm
50mm



x8 H2x100, H2.5x100, H3x100, H4x150, H5x150, H6x200, H8x200, H10x200

EVA MODULES SETS

11996 48,00€

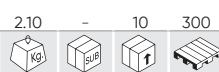

390mm
175mm
50mm



x10 6x7, 8x9, 10x11, 12x13, 14x15, 16x17, 18x19, 20x22, 24x27, 30x32mm

11997 39,00€

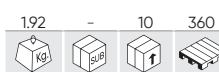

390mm
175mm
50mm



x8 6x7, 8x9, 10x11, 12x13, 14x15, 16x17, 18x19, 20x22mm

11998 49,00€

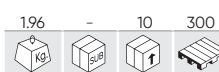

390mm
175mm
50mm



x17 6, 7, 8, 9, 10, 11, 12, 13, 14, 15, 16, 17, 18, 19, 20, 21, 22mm

13668 18,70€

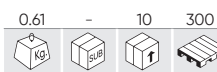

390mm
175mm
50mm



x1 3m
x1 230mm
x1 50mm
x1 250mm

11994 33,00€

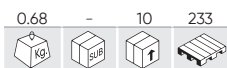

390mm
175mm
50mm



- x1 1/4" x1 250mm
- x1 1/4" x1 125mm
- x1 1/4"
- x13 4, 4.5, 5, 5.5, 6, 7, 8, 9, 10, 11, 12, 13, 14mm

14114 19,30€

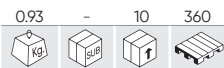

390mm
175mm
50mm



- x1 10"
- x1 10"

13667 17,60€

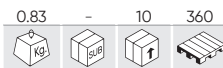

390mm
175mm
50mm



- x1 253mm
- 2x6, 3x7, 3x9, 6x10mm

13923 7,45€

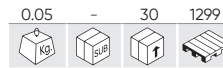

390mm
175mm
50mm

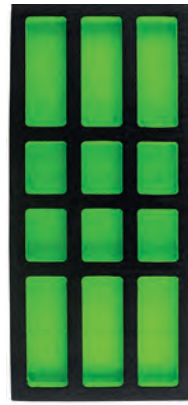

EMPTY

53671 41,00€

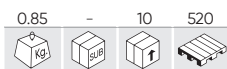

210mm
120mm
50mm



- x3 1/4" - 85 mm
- 1/2" - 135 mm
- 3/8" - 102 mm

53620 88,00€

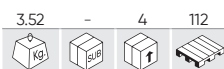

30mm 525mm 380mm



- x17 6, 7, 8, 9, 10, 11, 12, 13, 14, 15, 16, 17, 18, 19, 20, 21, 22mm
- x8 6x7, 8x9, 10x11, 12x13, 14x15, 16x17, 18x19, 20x22mm

PLASTIC TOOL SETS

10732 18,70€

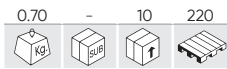

390mm
175mm
50mm



- x1 3m
- x1 230mm
- x1 50mm
- x1 250mm

10735 20,30€

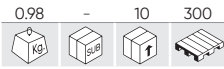

390mm
175mm
50mm



- x1 8"
- x1 8"
- x1 8"
- x1 8"

WALL PANEL

REF.	mm					€
52419	A 1000x600mm	7.07	-	1	30	80,00€
52420	B 1500x600mm	10.80	-	2	35	108,00€
52421	C 2000x600mm	14.00	-	1	38	172,00€

SQUARE HITCH

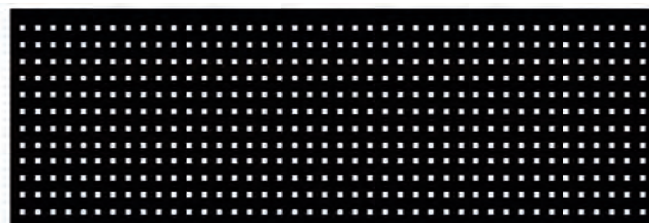

ACCESSORIES FOR TOOL TROLLEYS

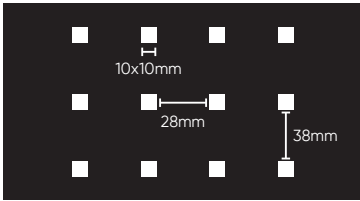

15068 15,20€

0.65	-	25	500



15069 32,80€

1.65	-	1	80



15313 14,00€

0.60	-	1	340

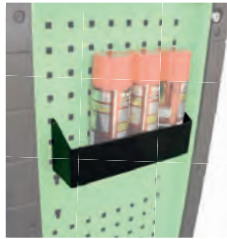

14354 14,00€

0.60	-	1	184



16359 10,00€

0.20	1	30	-	N

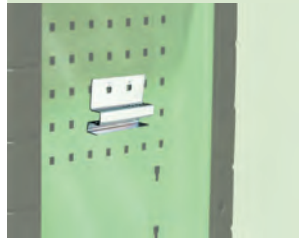

16361 16,50€

0.60	1	30	280	N



16362 20,00€

2.00	1	30	-	N

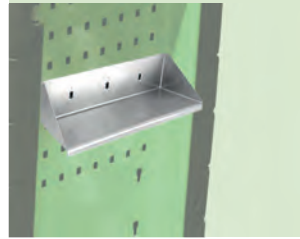

16363 14,50€

0.40	1	30	-	N



16344 43,00€

2.00	-	4	72	N

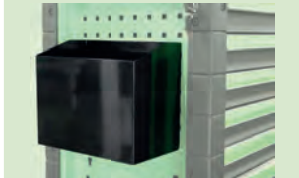

16358 12,00€

0.45	1	30	-	N

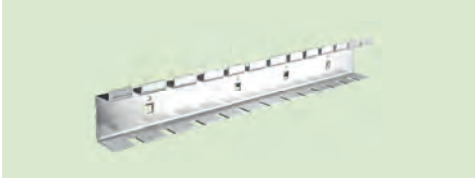

16360 12,00€

0.38	1	30	15	N



16354 1,50€

0.50	10	100	-	N

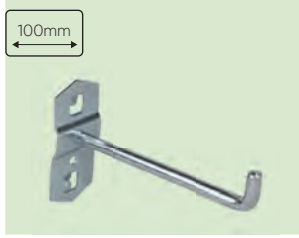

16355 2,00€

0.10	10	100	-	N

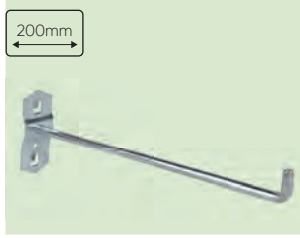

16356 2,50€

0.01	10	100	-	N

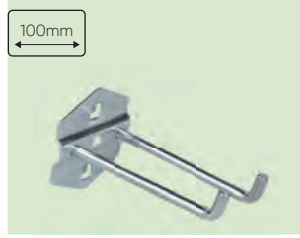

16357 2,50€

0.10	10	100	-	N

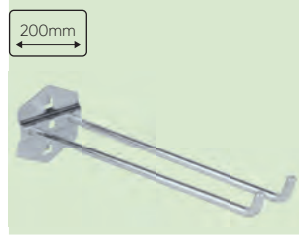

ACCESSORIES FOR TOOL TROLLEYS

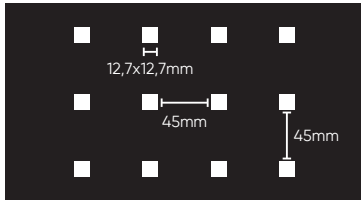

16161 17,50€

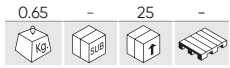

16162 35,10€

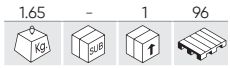

16163 10,20€

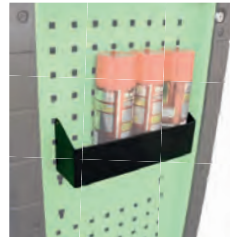
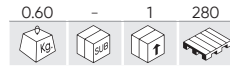

16188 39,60€

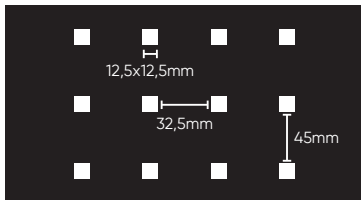

51655 4,10€

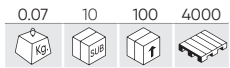

51976 1,63€

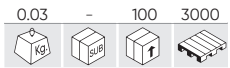

51658 4,50€

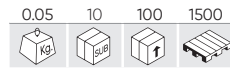

51422 2,97€



52634 5,25€

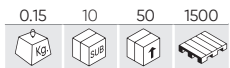

51975 2,27€

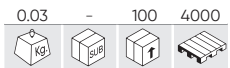

51419 2,79€

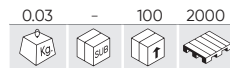

51656 3,65€



51654 4,80€

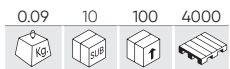

52635 4,80€

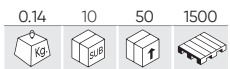

51657 5,85€

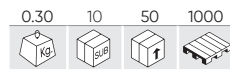

51653 5,10€



SPARE PARTS

REF.	DESCRIPTION					€
14578	SET OF 2 BIG BALL BEARING SLIDE FOR 53661 - 53686 - 54006	1.05	-	25	-	12,50€
14580	TOP CASE FOR REF. 53661 - 53686, 54006, 54389	2.60	-	3	39	41,00€
14783	RIGHT SIDE PROTECTOR FOR REF. 53686/53661/54006/54389	0.25	-	50	-	5,50€
15023	FIXED WHEEL FOR REF. 53765, 53766, 53870	0.65	-	10	-	12,50€
15024	SWIVEL WHEEL FOR REF. 53765, 53766, 53870	0.95	-	8	-	15,00€
15025	FIXED WHEEL FOR REF. 53900, 53901	0.65	-	10	-	12,50€
15026	SWIVEL WHEEL FOR REF. 53900, 53901	0.95	-	8	-	15,00€
15030	DRAWER HANDLE FOR REF. 53765, 53766	0.30	-	50	-	8,00€
15033	NARROW DRAWER HANDLE FOR REF. 53868	0.14	-	50	-	6,00€
15034	TOP COVER FOR REF. 53868	2.00	-	2	-	57,00€
15035	DRAWER HANDLE FOR REF. 53869	0.36	-	20	-	8,50€
15036	DRAWER HANDLE FOR REF. 53870	0.36	-	20	-	8,50€
15037	DRAWER HANDLE FOR REF. 53900, 53901	0.10	-	-	-	8,00€
15038	TOP COVER FOR REF. 53869, 53870	2.00	-	2	-	34,50€
15040	FIXED WHEEL FOR REF. 53904, 54006, 54389	0.66	-	10	-	12,50€
15041	SWIVEL WHEEL FOR REF. 53904, 54006, 54389	0.98	-	8	-	15,00€
15042	DRAWER HANDLE FOR REF. 53904, 54006	0.10	-	1	-	7,50€
15050	DRAWER HANDLE FOR REF. 53661, 53686	0.10	-	50	-	9,50€
15058	SIDE PROTECTOR FOR REF. 53868	0.36	-	-	-	7,50€
15065	SIDE PROTECTOR FOR REF. 53869, 53870	0.28	-	12	-	6,50€
16387	DRAWER HANDLE FOR REF. 54389	0.40	-	-	-	10,50€



PADLOCK

SHORT

REF.	DESCRIPTION					€
53403	38mm	0.15	8	96	3168	6,50€
53405	32mm	0.10	8	96	3168	5,30€
53406	50mm	0.30	8	48	1728	8,55€
53407	63mm	0.35	8	48	3168	12,70€
53408	75mm	0.48	3	24	840	19,30€

LARGE

REF.	DESCRIPTION					€
53404	38mm	0.15	8	96	3168	6,50€
53409	50mm	0.30	8	48	3168	9,00€



WATER RESISTANT PADLOCK

REF.	DESCRIPTION					€
53399	30mm	0.90	8	48	3168	3,50€
53400	40mm	0.20	8	48	499	5,70€
53401	50mm	0.35	8	48	499	7,40€
53402	65mm	0.05	10	40	499	9,60€



54388

366,00€

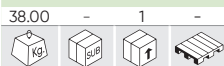

DIAGNOSTIC TROLLEY

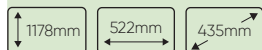

Multifunction workshop cart with four trays and a locked compartment. It is suitable for placing laptops, testers and battery chargers.

It has two handles and rotating wheels that facilitate transportation in a very comfortable way. It also includes a perforated panel, a paper roll holder and two side trays for storing tools.

TOP SHELF MEASUREMENTS	TOP SHELF	433x398mm
PERFORATED PANEL MEASUREMENTS		430x475mm
TOTAL SHELVES		4
CAPACITY		20Kg
WHEEL DIAMETER		101mm
WHEELS WITH BRAKES		2



N

REF. DESCRIPTION

REF.	DESCRIPTION	Kg	Sub	Qty	Wheels	€
16481	SWIVEL WHEEL WITH BRAKE (REF.54388)	11.60	-	20	-	14,00€
16482	WHEEL (REF.54388)	2.80	-	20	-	13,50€



51576

125,00€

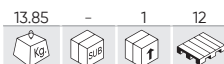

3-LEVEL WORKSHOP TROLLEY



52373

252,00€



LARGE 3-LEVEL WORKSHOP TROLLEY



51738

850,00€



WORKBENCH WITH 3 DRAWERS

GENERAL MEASURES



INTERIOR DRAWER MEASURES

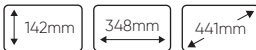

REF. DESCRIPTION

REF.	DESCRIPTION	Kg	Sub	Qty	Wheels	€
15144	RUBBER MAT FOR WORK TABLE REF. 51738	2.50	-	100	100	30,00€



51737

699,00€

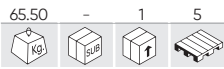

WORKBENCH WITH 2 DRAWERS



GENERAL MEASURES



INTERIOR DRAWER MEASURES



REF. DESCRIPTION

REF.	DESCRIPTION	Kg	Box	Drawer	Shelf	€
15145	SET OF 2 RUBBER MATS FOR WORK TABLE REF. 51737	1.90	-	100	100	20,45€

53674

447,00€

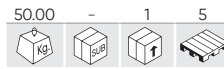

WORK TABLE WITH 1 DRAWER



GENERAL MEASURES



INTERIOR DRAWER MEASURES



REF. DESCRIPTION

REF.	DESCRIPTION	Kg	Box	Drawer	Shelf	€
15146	RUBBER MAT FOR WORK TABLE REF. 53674	1.35	-	100	100	16,20€

51035

799,00€

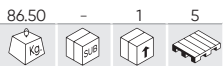

WORKBENCH WITH BACK PANEL



GENERAL MEASURES



SQUARE HITCH

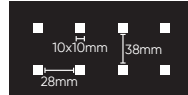

INTERIOR DRAWER MEASURES

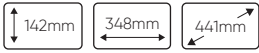

54328

199,00€



FOLDABLE WORKBENCH WITH BACK PANEL



N

GENERAL MEASURES

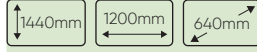

SQUARE HITCH

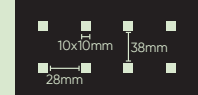

FOLDED MEASURES

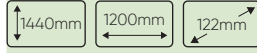

WORKING SURFACE

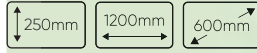

TOOLS NOT INCLUDED

50957

22,00€

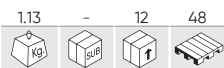

24 + 2 COMPARTMENT BOX



- 24 compartments (8 x 5.5 cm).
- 2 compartments (15 x 7.5 cm).
- Collapsible from 26 to 5 separations.

50959

14,00€

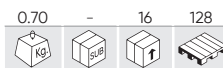

20 + 1 COMPARTMENT BOX



- 20 compartments (6 x 7 cm).
- 1 compartments (35 x 7 cm).
- Collapsible from 19 to 4 separations.

51051

34,80€

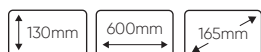
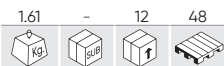

5 COMPARTMENT ORGANIZER



INSEPARABLE DRAWERS

51050

285,00€

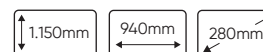

VERTICAL BIN RACK STORAGE WITH 47 COMPARTMENTS

LARGE COMPARTMENTS

Total: 15
Measurements: 24 x 14,5 x 13 cm
Shelf measurements: 84 x 14 x 24 cm
Total shelves: 3

SMALL COMPARTMENTS

Total: 32
Measurements: 16 x 10 x 7,5 cm
Shelf measurements: 84 x 16 x 8 cm
Total shelves: 4



51574

52,00€

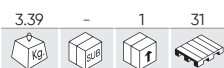

5 TRAY CANTILEVER TOOL BOX



GENERAL MEASURES



OPEN



CANTILEVER TOOL BOX

REF.						€
54393	750x200x220mm - 9Kg	7.70	-	1	15	92,00€
54394	530x200x220mm - 5,2Kg	5.70	-	1	22	64,00€
54395	450x200x220mm - 4,5Kg	6.20	-	1	24	53,00€



WORKSHOP FURNITURE

51575 317,00€

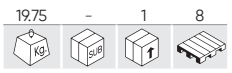

6 DRAWER TOOL CHEST BOX WITH SUPERIOR COMPARTMENT

GENERAL MEASURES



SMALL DRAWERS (X3)

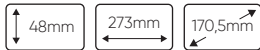

MEDIUM DRAWERS (X2)

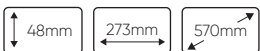

BIG DRAWER (X1)



51600 109,00€

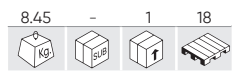

3 DRAWER TOOL CHEST BOX WITH SUPERIOR COMPARTMENT

GENERAL MEASURES



INTERIOR DRAWER MEASURES



53782 14,00€

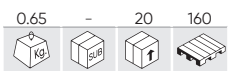

OPEN MOUTH TOOL BAG - LARGE

25 Kg 13L



53253 98,00€

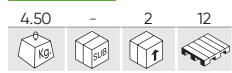

ROLLING TOOL BAG WITH TUBULAR HANDLE

20 Kg 18L



54080 53,50€



N

TOOLS BAG

20L



54374 75,50€



N

TOOL BAG

15 Kg





TOOL BAG

REF.	DESCRIPTION					€
53702	TOOL BAG - SMALL	1.00	-	5	180	28,50€
53703	TOOL BAG - MEDIUM	1.40	-	5	120	41,00€
53704	TOOL BAG - LARGE	1.65	-	5	120	42,00€

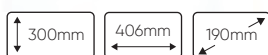

53903

59,00€

1.65	-	10	100

SUPER GRIP FLEXIBLE TOOL TRAY 3PCS SET

3
PCS



REF.	DESCRIPTION					€
15010	285x137x27mm	0.40	-	20	360	16,50€
15011	285x202x27mm	0.45	-	20	320	18,00€
15012	543x300x27mm	1.05	-	10	120	31,50€

FOLDABLE MAGNETIC TRAY

REF.	TOP Ø	BASE Ø	MAX DEPTH	MIN. DEPTH					€
52516	225mm	88mm	135mm	43mm	0.42	6	24	1152	28,00€
52517	135mm	53mm	90mm	31mm	0.10	12	72	1152	6,00€



50787 8,00€

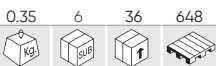

ROUND MAGNETIC TRAY Ø150MM



50788 14,50€

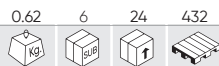

MAGNETIC RECTANGULAR TRAY



52466 11,00€

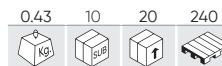

MAGNETIC TRAY

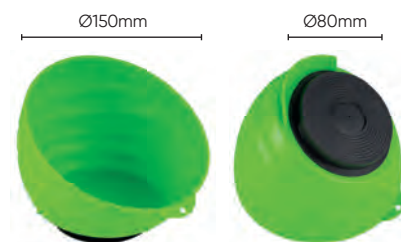

53958 6,50€

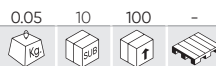

SET OF 5 MAGNETS



50789 29,00€

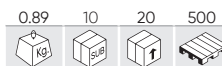

MAGNETIC BAR FOR TOOLS



53192 52,00€

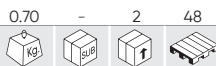

CLOSED-CELL EVA FOAM



GENERAL MEASURES



FOLDED SIZE

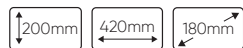

- EVA FOAM.

53191 14,80€



INDIVIDUAL FOAM MAT



GENERAL MEASURES



- EVA FOAM.

50843

79,00€

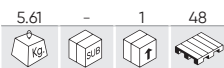

ADJUSTABLE WORK SEAT



MAX: 520mm
MIN: 390mm

Ø 295mm

Ø 380mm



50844

65,00€

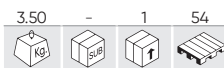

WORK STOOL



GENERAL MEASURES

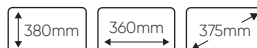

52148

65,00€

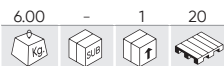

MECHANIC'S CREEPER



GENERAL MEASURES

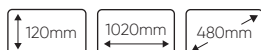

REF. DESCRIPTION

REF.	DESCRIPTION	kg	m³	units	€
11971	WHEEL FOR REF. 52148	0.20	5	50	3,60€

50808

77,00€

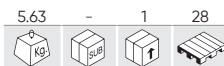

MECHANIC'S CAR CREEPER AND SEAT



GENERAL MEASURES



53211

75,00€

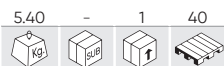

MECHANIC'S CAR CREEPER AND SEAT



GENERAL MEASURES



FOLDED SIZE



52542

109,00€



MECHANIC'S CAR CREEPER AND SEAT



GENERAL MEASURES

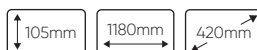

FOLDED SIZE



WORKSHOP FURNITURE

52869

52,00€

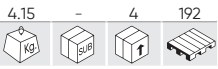

100MM WORKSHOP VICE



52870

100,00€

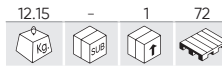

WORKSHOP VICE 150MM



53031

59,00€

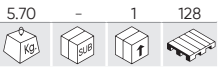

4" SWIVEL BASE VICE



53032

126,00€

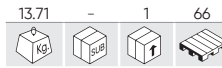

6" SWIVEL BASE VICE



52871

258,00€

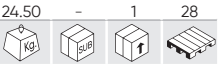

QUICK RELEASE 150MM VICE



FAST OPENING BY LEVER + ROTATING BENCH VISE

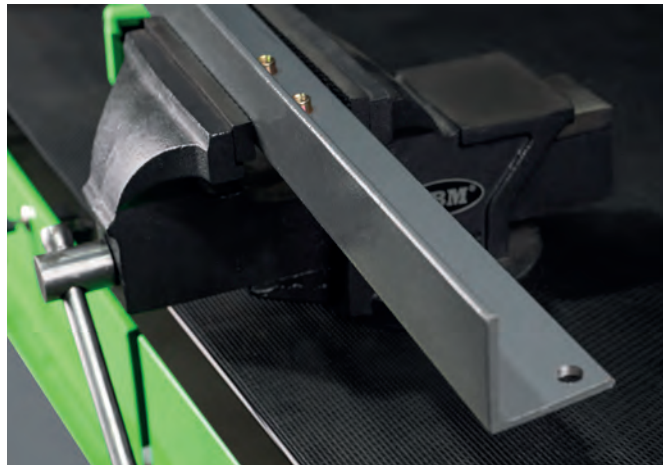

STEEL ANVIL

REF.	Kg.	mm					€
52308	50Kg	190x625x140mm	47.00	-	1	24	440,00€
52309	100Kg	245x790x180mm	100.00	-	1	8	941,00€

STEEL



POWER TOOLS CORDLESS

- 102 SCREWDRIVING
- 106 DRILLING
- 108 SANDING/POLISHING
- 110 SAWING
- 113 SPECIAL TOOLS
- 118 GARDENING POWER TOOLS
- 122 BATTERIES / CHARGERS
- 123 ACCESORIES / CONSUMABLES



**USE THEM WITH JBM BATTERIES:
A SINGLE BATTERY SUITABLE FOR ALL TOOLS**

THREE TYPES OF BATTERY AND TWO TYPES OF CHARGER.
CHOOSE THE ONE YOU PREFER!



60046C

339,00€

5.00 - 4 40



N

1/2" 550NM CORDLESS BRUSHLESS IMPACT WRENCH WITH CASE

IT INCLUDES

REF.	DESCRIPTION					€
60013	4.0 AH LI-ION BATTERY	0.75	-	5	700	80,00€
60016	20V CHARGER - 4A	0.80	-	5	210	49,00€
60046	1/2" BRUSHLESS IMPACT WRENCH 550NM	1.50	-	4	200	174,00€

This tool is designed for tightening and loosening nuts and bolts that require high torque. It comes equipped with an LED work light and a rotation direction selector that also allows locking the trigger and preventing accidental starting of the tool.

It has 5 different gears, 3 for tightening and 2 for loosening, allowing you to adjust the speed according to the operation to be performed. In addition, thanks to its ergonomic handle, a better grip and precision is achieved.

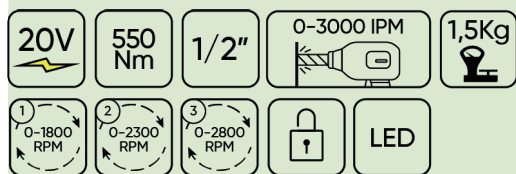

- BRUSHLESS MOTOR
- LED WORK LIGHT
- FORWARD/REVERSE SELECTOR
- ERGONOMIC HANDLE
- 5 DIFFERENT GEARS
- BELT HOOK

THE COMPARTMENTS IN OUR CASES ARE COMPATIBLE WITH 4.0AH AND 6.0AH BATTERIES.



60046

174,00€

1.50 - 4 200



N

1/2" BRUSHLESS IMPACT WRENCH 550NM

BATTERY NOT INCLUDED.



**USE THEM WITH JBM BATTERIES:
A SINGLE BATTERY SUITABLE FOR ALL TOOLS**

THREE TYPES OF BATTERY AND TWO TYPES OF CHARGER.
CHOOSE THE ONE YOU PREFER!



60044C

485,00€



1/2" 1300NM BRUSHLESS IMPACT WRENCH WITH STORAGE CASE

IT INCLUDES

REF.	DESCRIPTION	kg	L	QTY	€
60013	4.0 AH LI-ION BATTERY	0.75	-	5 700	80,00€
60016	20V CHARGER - 4A	0.80	-	5 210	49,00€
60044	1/2" 1300NM BRUSHLESS IMPACT WRENCH	3.25	-	5 90	330,00€

This tool has been designed to tighten and loosen lug nuts and screws which requires a high torque. It has a new generation X-TorQ brushless motor that allows you to unscrew stuck or very tight screws and nuts up to 2 times faster. Robust and durable. With aluminium casing protected with elastomer on the front.

It is equipped with a work LED light and a rotation selector which also allows you to lock off the trigger and prevent an accidental starting of the tool. It has 5 different gears, 3 for tightening and 2 for loosening, allowing a speed adjustment according to operation to be carried out. Its newly designed double hammer provides more IPM and less vibration.

New socket holding ring: faster socket changing, and more secure clamping. Perfect tool balance and weight, for jobs that require large sockets and high levels of torque. Large hook useful for hanging the machine on metal structures or on the work belt. Also, it has an ergonomic handle for an improved grip and precision.

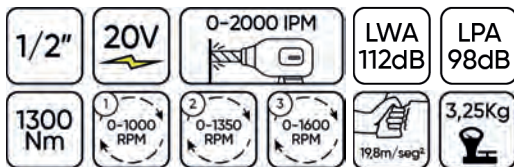

- BRUSHLESS MOTOR
- LED WORK LIGHT
- FORWARD/REVERSE SELECTOR
- ERGONOMIC HANDLE
- 5 DIFFERENT GEARS
- BELT HOOK

THE COMPARTMENTS IN OUR CASES ARE COMPATIBLE WITH 4.0AH AND 6.0AH BATTERIES.

60044

330,00€

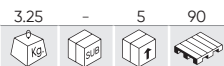

1/2" 1300NM BRUSHLESS IMPACT WRENCH

BATTERY NOT INCLUDED.



60048C

560,00€

7.15	-	4	32

N

3/4" 1300NM CORDLESS BRUSHLESS IMPACT WRENCH WITH CASE

IT INCLUDES

REF.	DESCRIPTION					€
60015	6.0AH LI-ION BATTERY	1.00	-	20	630	138,00€
60016	20V CHARGER - 4A	0.80	-	5	210	49,00€
60048	3/4" 1300NM BRUSHLESS IMPACT WRENCH	3.26	-	4	64	366,00€

This tool has been designed for tightening and loosening nuts and bolts that require high torque. It is equipped with an LED work light and a rotation selector that also allows you to lock the trigger and prevent accidental starting of the tool.

It has 5 different gears, 3 for tightening and 2 for loosening, allowing you to adjust the speed according to the operation to be carried out. In addition, it has an ergonomic handle for better grip and precision.

- BRUSHLESS MOTOR
- LED WORK LIGHT
- FORWARD/REVERSE SELECTOR
- ERGONOMIC HANDLE
- 5 DIFFERENT GEARS
- BELT HOOK

THE COMPARTMENTS IN OUR CASES ARE COMPATIBLE WITH 4.0AH AND 6.0AH BATTERIES.



60048

366,00€

3.26	-	4	64

N

3/4" 1300NM BRUSHLESS IMPACT WRENCH

BATTERY NOT INCLUDED.



60005

132,00€

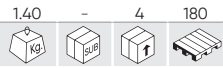

BRUSHLESS SCREWDRIVER

BATTERY NOT INCLUDED.

Brushless impact driver ref. 60005 designed to drive in screws and tighten nuts quickly, especially when working with long fasteners and tough materials. It is equipped with a LED working light to improve accuracy while working, a 1/4" hex quick change toolless chuck type for a fast bit's insertion and removal, and a trigger switch which can be locked to prevent an accidental starting of the tool.

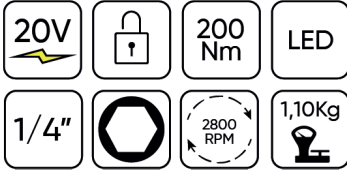

- A BRUSHLESS MOTOR
- B LED WORK LIGHT
- C FORWARD/REVERSE SELECTOR
- D ERGONIMIC HANDLE
- E 5 DIFFERENT GEARS
- F BELT HOOK
- G BATTERY NOT INCLUDED



ACCESSORIES AND SPARE PARTS

PAGE 126

60024

190,00€

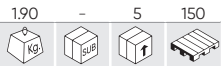

1/2" BRUSHLESS RATCHET - 12V

BATTERY NOT INCLUDED.

This tool is designed to tighten and loose screws in reduced spaces.

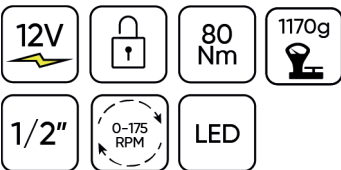

- A 1/2" SQUARE HEAD
- B DIRECTIONAL SWITCH: FORWARD/REVERSE TOGGLE
- C BUILT-IN LED WORK LIGHT
- D BATTERY DISPLAY
- E LOCK SWITCH
- F VARIABLE SPEED
- G OVERLOAD PROTECTION

IT INCLUDES

REF.	DESCRIPTION	kg	boxes	mm	€
60025	12V CHARGER – FOR REF. 60026	0.30	5	4 700	31,60€
60026	2.0 AH LI-ION SAMSUNG BATTERY – FOR REF. 60024	0.20	5	40 1400	37,90€



60023

212,00€



BRUSHLESS ROTARY HAMMER

BATTERY NOT INCLUDED.

This tool is designed to perform impact drilling and chiseling tasks in concrete and brick, as well as tasks in other materials such as steel, wood, metal, ceramic and plastic where normal drilling is required.

20V	3x SDS (8,10,12x150mm)	1350 RPM	LED	2,2J
Ø MAX.			2,10Kg	0-4750 IPM
WOOD 28mm	CONCRETE 22mm	STEEL 13mm		

- A BRUSHLESS MOTOR
- B DEPTH GAUGE
- C DUST PROTECTION CAP
- D SDS BIT HOLDER LOCKING SLEEVE
- E FUNCTION MODE SELECTOR SWITCH
- F FORWARD/REVERSE ROTATION SELECTOR
- G ERGONIMIC HANDLE
- H LED WORK LIGHT
- I BATTERY NOT INCLUDED



- IT INCLUDES**
- 1PC: DUST COVER
 - 1PC: DEPTH GAUGE
 - 1PC: AUXILIARY HANDLE
 - 1PC: POINT CHISEL
 - 1PC: FLAT CHISEL
 - SDS DRILL BITS: 8/10/12 X 150MM



ACCESSORIES AND SPARE PARTS

PAGE 123

60006

182,00€



2-SPEED IMPACT DRILL

BATTERY NOT INCLUDED.

This tool is designed to carry out drilling tasks in wood and metal, drilling impact tasks, more common in masonry, in concrete, stone and red brick, as well as to tighten, loosen or remove screws and nuts.

20V	80 Nm	1/2"	0-29750 IPM
1/2"	0-29750 IPM	0-500 RPM	0-1750 RPM
		LED	1,67Kg

- A BRUSHLESS MOTOR
- B LED WORK LIGHT
- C FORWARD/REVERSE SELECTOR
- D ERGONIMIC HANDLE
- E BELT HOOK
- F BATTERY NOT INCLUDED



AUXILIARY HANDLE



ACCESSORIES AND SPARE PARTS

PAGE 124

60047C

318,00€



N

DOUBLE SPEED IMPACT DRILL WITH STORAGE CASE

IT INCLUDES

REF.	DESCRIPTION					€
60013	4.0 AH LI-ION BATTERY	0.75	-	5	700	80,00€
60016	20V CHARGER - 4A	0.80	-	5	210	49,00€

This tool has been designed to drill holes on different types of materials. It can carry out drilling tasks in wood and metal and drilling impact tasks, more common in masonry, in concrete, stone and red brick.

Also, it can tighten, loosen or remove nuts and screws. To do this, it has an adjustment ring that allows you to choose among 20 different torque settings. It has a speed selector and a forward/reverse selector to set the rotation direction to left or right. This selector, if placed on its middle position, blocks the trigger switch to prevent an accidental starting of the tool. It is equipped with a LED light for better visualisation of the working area. As accessories it has a belt hook and an auxiliary handle for an improved grip.



- BRUSHLESS MOTOR
- LED WORK LIGHT
- FORWARD/REVERSE SELECTOR
- ERGONOMIC HANDLE
- 5 DIFFERENT GEARS
- BELT HOOK
- AUXILIARY HANDLE

THE COMPARTMENTS IN OUR CASES ARE COMPATIBLE WITH 4.0AH AND 6.0AH BATTERIES.



ACCESSORIES AND SPARE PARTS

PAGE 124



60009

168,00€



BRUSHLESS POLISHER

BATTERY NOT INCLUDED.

This tool has been designed for finishing processes such as polishing and rounding off corners and edges, as well as for achieving smooth surfaces by means of its wheel and polishing pad.



- A BRUSHLESS MOTOR
- B 9 STAGE SPEED SELECTION:
800, 1000, 1200, 1400, 1600, 1800, 2000, 2200, 2400 RPM
- C SAFETY SWITCH
- D SOFT GRIP HANDLE
- E AUXILIARY D HANDLE
- F SPINDLE LOCK
- G POLISHER PAD
- H BATTERY NOT INCLUDED



HEX WRENCH



SPARE PARTS AVAILABLE



60033

104,00€



BRUSHLESS ORBITAL SANDER

BATTERY NOT INCLUDED.

This tool is designed for sanding wood, iron, plastic and similar materials using suitable sandpaper. This sander is adjustable to three different speeds, has a comfortable grip and has a built-in dust collection bag.



- A BRUSHLESS MOTOR
- B ON SWITCH/SPEED CONTROL BUTTON
- C OFF SWITCH
- D DUST BAG
- E BASE
- F BATTERY NOT INCLUDED



SPARE PARTS AVAILABLE

60049C

329,00€

5.53	-	4	32

N

BRUSHLESS ANGLE GRINDER 125MM WITH STORAGE CASE

IT INCLUDES

REF.	DESCRIPTION					€
60013	4.0 AH LI-ION BATTERY	0.75	-	5	700	80,00€
60016	20V CHARGER - 4A	0.80	-	5	210	49,00€

BATTERY NOT INCLUDED.

The cordless angle grinder is designed to perform all types of cutting, polishing and sanding tasks. It includes a frontal handle and a protection cover.

20V
M14

Ø 125mm

1,79Kg

8000 min⁻¹

- WHEEL GUARD _____
- SIDE HANDLE _____
- BATTERY NOT INCLUDED _____

THE COMPARTMENTS IN OUR CASES ARE COMPATIBLE WITH 4.0AH AND 6.0AH BATTERIES.



ACCESSORIES AND SPARE PARTS

PAGE 127

SPARE PARTS AVAILABLE

60028

142,00€

1.95	-	4	144

BRUSHLESS ANGLE GRINDER - 125MM

BATTERY NOT INCLUDED.

The cordless angle grinder is designed to perform all types of cutting, polishing and sanding tasks. It includes a frontal handle and a protection cover.



20V
M14

8000 RPM

Ø 125mm

1,50Kg



ACCESSORIES AND SPARE PARTS

PAGE 127

SPARE PARTS AVAILABLE

60019

178,00€

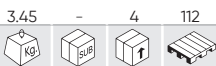

RECIPROCATING SAW

BATTERY NOT INCLUDED.

This tool is designed to perform cutting tasks in a wide variety of materials and can be used for multiple applications. Its design allows a fast and convenient blade change by means of its toolless collet sleeve, as well as a variable cutting speed to better adapt to the operation to be performed.



- A BRUSHLESS MOTOR
- B SAW BLADE
- C SHOE
- D TOOLLESS COLLET
- E TRIGGER SWITCH LOCK-OFF BUTTON
- F SOFT GRIP HANDLE
- G BATTERY NOT INCLUDED



ACCESSORIES AND SPARE PARTS

SPARE PARTS AVAILABLE

PAGE 128

IT INCLUDES
1PC: WOOD BLADE
1PC: METAL BLADE

60020

175,00€



BRUSHLESS PLANER

BATTERY NOT INCLUDED.

This tool is designed to perform woodworking tasks. It can be used to achieve a smooth finish in wood surfaces chamfering corners or marking rabbets.

This tool has an aluminum alloy base to provide accuracy while planing, a dust collection system to capture the woodworking dust, and a trigger switch lock-off button to prevent an accidental starting of the tool

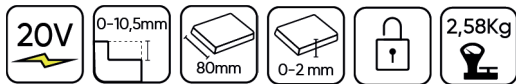

- A BRUSHLESS MOTOR
- B LOCK-OFF BUTTON
- C CUTTING DEPTH ADJUSTMENT KNOB
- D PARALLEL GUIDE
- E RABBETING DEPTH GUIDE
- F RABBETING GUIDE ADJUSTMENT KNOB
- G DUST EXTRACTION PORT
- H V-GROOVE
- I BATTERY NOT INCLUDED



IT INCLUDES
1PC: RABBETING DEPTH ADJUSTING KNOB
1PC: PARALLEL GUIDE
3PCS: LOCKING KNOB
1 PC: WRENCH
1PC: SCREW

SPARE PARTS AVAILABLE

60010

170,00€

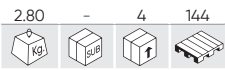

BRUSHLESS JIG SAW

BATTERY NOT INCLUDED.

This tool has been designed to carry out cutting tasks in different materials such as wood, steel, plastic and metal. It features 4 pendulum action positions: 3 orbital cutting actions and 1 straight cutting action, which allows to adapt the blade cutting speed according to the material hardness.

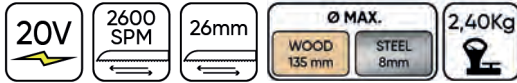

- A BRUSHLESS MOTOR
- B BLADE GUARD
- C TOOLLESS COLLET
- D SAW BLADE
- E PENDULUM CUTTING KNOB
- F SHOE ADJUSTMENT LEVER
- G TRIGGER SWITCH LOCK-OFF BUTTON
- H BATTERY NOT INCLUDED



SPARE PARTS AVAILABLE

ACCESSORIES AND SPARE PARTS

PAGE 128



IT INCLUDES

- 1PC: WOOD BLADE
- 1PC: EDGE GUIDE
- 1PC: DUST PIPE

60007

170,00€

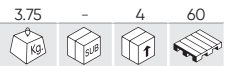

BRUSHLESS CIRCULAR SAW

BATTERY NOT INCLUDED.

This tool has been designed to perform wood cutting tasks. The saw of blade of 165mm in diameter and 24 teeth makes it ideal for carry out straight longitudinal and transverse cuts in wood panels and panels, as well as angle cuts of up to 45°.



- A BRUSHLESS MOTOR
- B LEVER FOR LOWER GUARD
- C SHOE
- D LOWER GUARD
- E ANGLE LOCKING KNOB
- F FRONT HANDLE
- G TRIGGER SWITCH LOCK-OFF BUTTON
- H BATTERY NOT INCLUDED



SPARE PARTS AVAILABLE

ACCESSORIES AND SPARE PARTS

PAGE 128



IT INCLUDES

- 1PC: 165MM 24T TCT BLADE
- 1PC: EDGE GUIDE
- 1PC: HEX KEY

60011

175,00€

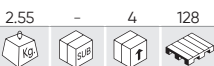

MINI CIRCULAR SAW

BATTERY NOT INCLUDED.

This tool has been designed to perform wood cutting tasks. The saw of blade of 115mm in diameter and 24 teeth makes it ideal for carry out straight longitudinal and transverse cuts in wood panels and panels, as well as angle cuts of up to 45°. This circular saw also features a trigger lock-off button to prevent an accidental starting of the tool, and an aluminum guard.



- A BRUSHLESS MOTOR
- B LOWER BLADE GUARD
- C LOWER GUARD LEVER
- D BASE PLATE
- E UPPER BLADE GUARD
- F RIP GUIDE
- G LOCK-OFF BUTTON
- H BATTERY NOT INCLUDED



- IT INCLUDES**
- 1PC: 115MM 24T TCT BLADE
 - 1PC: EDGE GUIDE
 - 1PC: DUST PIPE
 - 1PC: HEX KEY



SPARE PARTS AVAILABLE

ACCESSORIES AND SPARE PARTS

PAGE 128

60022

470,00€

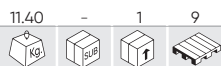

SLIDE MITRE SAW

BATTERY NOT INCLUDED.

This tool is designed to perform cutting tasks in wood and wood-like materials. It can be used to make bevel cuts, where an inclined cut over the workpiece surface is required, miter cuts, commonly used for joints that form an angle of 90°, as well as compound cuts, where a simultaneous angle cut on the edge and front surface of the workpiece is required.

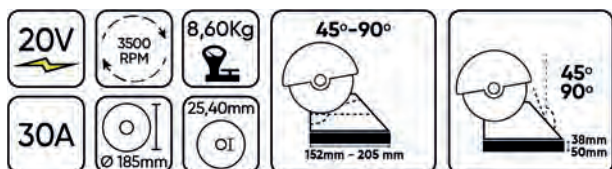

- IT INCLUDES**
- 1PC: CLAMP
 - 1PC: BLADE WRENCH
 - 1PC: DUST EXTRACTION BAG



SPARE PARTS AVAILABLE

ACCESSORIES AND SPARE PARTS

PAGE 128



60032

123,00€

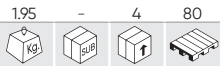

BATTERY CAULKING GUN

BATTERY NOT INCLUDED.

This tool is designed to seal up any gap or crack in a wide variety of materials such as metal, glass, wood and ceramic.



- A CARTRIDGE HOLDER
- B PLUNGER
- C PLUNGER ROD
- D PLUNGER ROD HANDLE
- E PLUNGER ROD RELEASE TRIGGER
- F VARIABLE SPEED DIAL
- G LED LIGHT
- H BATTERY NOT INCLUDED



SPARE PARTS AVAILABLE

60038

255,00€

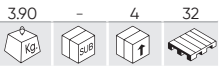

CORDLESS GREASE GUN

BATTERY NOT INCLUDED.

This tool has been designed for lubricating purposes and can be easily transported and manipulated wherever thanks to its cordless design.



- A GREASE FLOW RATE ADJUSTMENT WHEEL
- B LOCK-OFF BUTTON
- C SOFT ERGONOMIC HANDLE
- D FLEXIBLE HOSE
- E GREASE TUBE
- F SAFETY PURGE VALVE
- G BATTERY NOT INCLUDED



SPARE PARTS AVAILABLE

60041

77,00€



BRUSHLESS OSCILLATING MULTI TOOL UNIT

BATTERY NOT INCLUDED.

The oscillating electric multitool allows you to put different types of accessories so you can carry out a variety of tasks. It is especially useful for scraping, sanding and plunge cutting in narrow spaces.

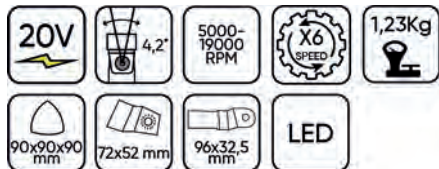

- A BRUSHLESS MOTOR
- B CLAMPING LEVER
- C LOCKING BRACKET
- D ADJUSTMENT WHEEL FOR SPEED SELECTION
- E WORK LIGHT
- F TOOL HOLDER
- G BATTERY NOT INCLUDED



- IT INCLUDES**
- 1PC: PLUNGE SAW BLADE
 - 1PC: SANDING SHEET
 - 1PC: SANDING PLATE
 - 1PC: SCRAPER
 - 1PC: WASHER
 - 1PC: HANDLE

60037

222,00€



NAIL GUN

BATTERY NOT INCLUDED.

This tool is designed for tacking of cardboard, insulating material, fabric, foils, leather and similar materials on surfaces of wood or wood-like materials by means of its high-power compressed air driven impact firing.



- A LED LIGHT
- B SAFETY CONTACT PIN
- C MAGAZINE
- D LED LIGHT INDICATOR
- E DRIVE SHIFT KNOB
- F LED LIGHT SWITCH
- G BATTERY NOT INCLUDED



ACCESSORIES AND SPARE PARTS

PAGE 127

18 GAUGE NARROW CROWN LIGHT DUTY STAPLES

MAX. LENGTH OF STAPLES	40 mm
MAX. STAPLE CROSS SECTION WIDTH	1.2 mm
MAX. STAPLE CROSS SECTION THICKNESS	1 mm
MAX. STAPLES CROWN	6 mm

18 GAUGE BRAD NAILS

MAX. LENGTH OF NAILS	50 mm
MAX. NAIL CROSS SECTION WIDTH	1.25 mm
MAX. NAIL CROSS SECTION THICKNESS	1.05 mm

60042

106,00€

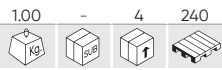

CORDLESS HEAT GUN

BATTERY NOT INCLUDED.

This cordless hot gun mainly usage purpose is: shrink PVC, soldering, curling plastic spare part and ordinary drying, melting and unfreezing.

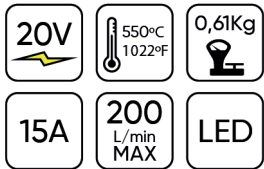

- A FRONT COVER
- B NOZZLE
- C LED LIGHT
- D POWER SWITCH LOCK
- E METAL HOOK
- F BATTERY NOT INCLUDED



SPARE PARTS AVAILABLE

60043

123,00€

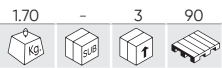

CORDLESS PAINT SPRAYER

BATTERY NOT INCLUDED.

This tool is designed for spraying paint on indoor and outdoor surfaces.



- A FLOW REGULATOR
- B TANK
- C TANK LOCKDOWN
- D AIR FILTER
- E BATTERY NOT INCLUDED



SPARE PARTS AVAILABLE

USE THEM WITH JBM BATTERIES: A SINGLE BATTERY SUITABLE FOR ALL TOOLS

THREE TYPES OF BATTERY AND TWO TYPES OF CHARGER. CHOOSE THE ONE YOU PREFER!

* Batteries and chargers NOT INCLUDED in the tools.



60001

88,00€



HANDHELD VACUUM CLEANER

BATTERY NOT INCLUDED.

This cordless electric vacuum cleaner has been designed to vacuum any material which is not harmful to one's health.

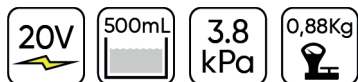

- A DUST CUP
- B RELEASE BUTTON FOR DUST CUP
- C ON/OFF SWITCH
- D MOTOR HOUSING
- E CREVICE NOZZLE
- F BRUSH NOZZLE
- G FLOOR NOZZLE
- H EXTENSION TUBE
- I BATTERY NOT INCLUDED



IT INCLUDES

REF.	DESCRIPTION					€
14950	EXTENSION TUBE FOR REF. 60001	0.08	5	10	-	6,50€
14951	CREVICE NOOZLE FOR REF. 60001	0.01	-	10	-	9,50€
14952	FLOOR NOZZLE FOR REF. 60001	0.15	-	5	-	19,00€
14953	BRUSH NOZZLE FOR REF. 60001	0.05	-	10	-	8,50€

60003

110,00€



ELECTRIC AIR COMPRESSOR PUMP

BATTERY NOT INCLUDED.

This inflator allows you to inflate car and bike tires, balls, rafts, air mattresses, swimming pool floats, etc.



- A LED LIGHT
- B LED LIGHT SWITCH
- C WORKING MODE SWITCH
- D PRESSURE SETTING BUTTONS
- E USB PLUG
- F HIGH PRESSURE HOSE
- G HIGH CAPACITY HOSE
- H 12V DC CIGARETTE PLUG
- I BATTERY NOT INCLUDED



IT INCLUDES



60004

79,00€

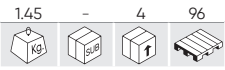

LED WORK LIGHT

BATTERY NOT INCLUDED.

This LED working light has been designed to ensure a perfect illumination of the working area and any other place. If the battery runs out, it is possible to connect the power cable provided into the slot at the rear side of the work light and plug it into the 230V power supply.

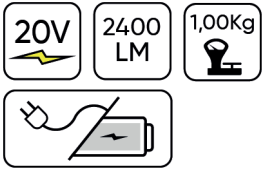

- A ON/OFF SWITCH
- B WORK LIGHT HEAD
- C LED'S LENTS
- D SIDE LOCKING KNOB
- E POWER CABLE
- F BATTERY NOT INCLUDED



REF.	DESCRIPTION					€
15049	TRIPOD FOR LED WORKING LIGHT (REF. 60004)	2.10	-	4	120	37,40€

60035

30,00€

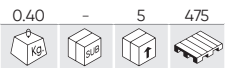

PORTABLE WORKING LED LIGHT

BATTERY NOT INCLUDED.

This LED work light has been designed to ensure a perfect illumination of the working area and any other place. Its operation with the portable lithium battery makes it ideal to move it freely all over the workplace, as well as in situations when there is no access to the electrical power supply.

The LED light lens provides an output which can be adjusted to 500 and 1000 lumens, and the work light head features a 90° adjustment angle to adapt the direction of the light bulb as appropriate. It also includes a soft grip handle for a better control and comfort, and a utility hook to attach it to any object.

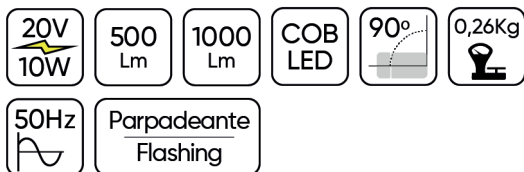

- A LED LENS
- B ROTATING LAMP HEAD
- C UTILITY HOOK
- D ON/OFF SWITCH
- E BATTERY NOT INCLUDED



60039

265,00€

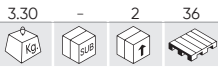

BRUSHLESS ELECTRIC PRESSURE WASHER GUN

BATTERY NOT INCLUDED.

The brushless electric pressure washer is designed to clean the workplace, home, tools and equipment, decks, boats, outdoor furniture and vehicles.



- A BRUSHLESS MOTOR
- B 5 POSITION ROTATING NOZZLE
- C QUICK-CONNECT NOZZLE COUPLING
- D WAND
- E PRESSURE INDICATOR
- F PRESSURE SELECTOR SWITCH
- G LOCK SWITCH
- H HOSE QUICK CONNECT ADAPTER
- I BATTERY NOT INCLUDED



SPARE PARTS AVAILABLE



60027

99,00€

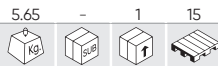

BACKPACK SPRAYER 15L REF. 60027

BATTERY NOT INCLUDED.

Suitable for environmental disinfection of houses, public spaces, livestock farms, gardens, etc., contributing to the eradication of all infectious particles and its spread, as well as the prevention of pests and diseases. Diaphragm pump smart handle switch which can be locked on for a continuous operation. Equipped with 4 different nozzles to adapt the spraying flow and power according to the spraying need required: 1 hollow cone nozzle, 1 dual hollow cone nozzle, 1 4-hole adjustable nozzle, 1 fan nozzle.

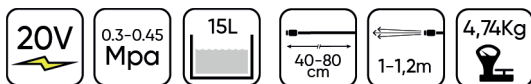

- A HANDLE FOR EASY CARRYING
- B BREATHABLE AND ERGONOMIC BACK PAD
- C REFILL CAP WITH ANTI-RELEASE DESIGN
- D EXTENSIBLE TELESCOPIC SPRAYING LANCE
- E BATTERY NOT INCLUDED

DOES NOT ACCEPT 6.0AH BATTERIES

IT INCLUDES



60029

240,00€

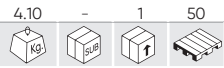

BRUSHLESSTO BATTERY CHAINSAW

BATTERY NOT INCLUDED.

This tool for forest service has been designed to perform wood-cutting tasks such as tree felling, limbing, bucking and cutting.

It is equipped with a knob to adjust the guide bar and chain tension, a chain brake to stop the chain if you get a kickback, and a chain catcher to catch it if it snaps or jumps off. Besides, it features an automatic system for chain lubrication and a trigger switch lock-off button to avoid an accidental starting of the tool. It also includes bar guide, a chain and a cover to protect both the bar and chain for storage and transportation.



- A BRUSHLESS MOTOR
- B SAW CHAIN
- C GUIDE BAR
- D CHAIN BRAKE/FRONT HAND GUARD
- E FRONT HANDLE
- F LOCK-OFF BUTTON
- G OIL RESERVOIR CAP
- H BATTERY NOT INCLUDED



IT INCLUDES



60030

112,00€

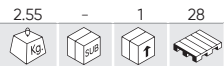

BATTERY BLOWER

BATTERY NOT INCLUDED.

This tool is designed to blow-sweeping leaves, grass, paper and similar materials. Powered with a lithium-ion battery, it is ideal to transport from one place to another thanks to its cordless design and light weight. It features a switch for a high or low air flow speed and volume configuration and a soft grip handle for a better control and grip.



- A BRUSHLESS MOTOR
- B BLOWER TUBE
- C BLOWER TUBE LUG
- D HOUSING
- E BATTERY NOT INCLUDED

DOES NOT ACCEPT 6.0AH BATTERIES

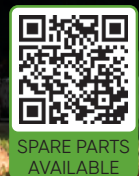

60031

142,00€



BATTERY HEDGE TRIMMER

BATTERY NOT INCLUDED.

This tool is designed to perform gardening tasks such as trimming, cutting or pruning hedges or bushes in a fast and convenient way. Powered with a lithium-ion battery, it is ideal to transport from one place to another thanks to its cordless design and light weight.

It comes equipped with a blade cover to help keep the trimmer in good conditions, a guard that helps to deflect chips or other debris away from the operator's hands and eyes, and an auxiliary handle for a better control and comfort. Besides, it features two switches and a lock-off button to prevent an accidental start-up of the tool.



- A BRUSHLESS MOTOR
- B CUTTING BLADE
- C BLADE SUPPORT ROD
- D GUARD
- E AUXILIARY HANDLE
- F AUXILIARY SWITCH
- G LOCK-OFF BUTTON
- H REAR HANDLE
- I BATTERY NOT INCLUDED



IT INCLUDES
BLADE COVER



60040

440,00€



ELECTRIC 4-IN-1 GARDEN MULTI FUNCTION TOOL

BATTERY NOT INCLUDED.

The electric multi-function 4 in 1 garden machine is designed for a multiple of outdoor tasks, such as clearing green spaces, trimming garden hedges, cutting branches, etc. It is an ideal product for all-round garden maintenance.

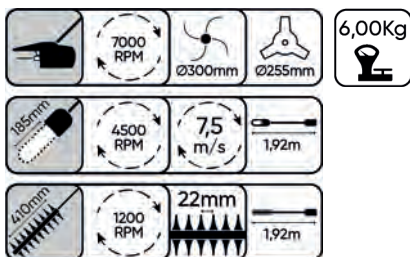

- A BRUSHLESS MOTOR
- B PROTECTOR
- C THREE-TOOTH BLADE
- D BLADE
- E SAW
- F HANDLES
- G BRUSH CUTTER
- H THREAD HEAD
- I HEDGE TRIMMER
- J POLE SAW
- K BATTERY NOT INCLUDED



52598

1.080,00€

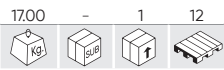

ROBOTIC LAWN MOWER

Modern and functional robotic lawnmower, perfect for the care and maintenance of your lawn and green spaces. It is equipped with a brushless motor, powered by a powerful 5200 Ah battery, for a range of approximately 150 minutes. The cutting deck with three steel blades that will perform a mulching cut. This cutting system shreds the grass very finely, and then drops it directly on the ground, giving the lawn an impeccable appearance without proceeding to remove the remains. In addition, with this cut, the grass deposited on the lawn will decompose and become a nutrient for the soil, creating a completely natural biological cycle. The perimeter wire and stakes supplied allow for easy, tool-free installation.

5200 mAh Capacidad de la batería battery capacity	1400m ² Superficie de corte mowing area	IP X4	DC 15-25.5V tensión de salida battery de salida	2,5h	22m/min
115,44W consumo de energía power consumption	AC 100-240V 50/60Hz tensión de entrada input voltage	7,5Kg	2h	70 dB(A)	50-35,5-24 cm



APP CONNECTION



- A BRUSHLESS MOTOR
- B STOP BUTTON
- C CHARGING STATION
- D REAR WHEEL
- E KNOB LID

60045

298,00€

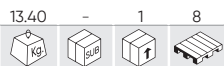

CORDLESS LAWN MOWER

BATTERY NOT INCLUDED.

This cordless mown mower helps you to keep your garden in perfect condition. It is equipped with a brushless motor which increases efficacy and reduces the noise level. It is also very light and easy to use.

40V	800W	35L	11,6 Kg.
3.300 RPM	6x 25-75mm	152 - 203mm Ø	370mm Ø
96 dB(A)	IP X1	4.0A	11,40Kg



- A BRUSHLESS MOTOR
- B LAWN MOWER
- C HANDLE
- D GRASS CATCHER BAG

WORKS WITH 2 4AH BATTERIES (NOT INCLUDED)



**USE THEM WITH JBM BATTERIES:
A SINGLE BATTERY SUITABLE
FOR ALL TOOLS**

THREE TYPES OF BATTERY AND TWO TYPES OF CHARGER. CHOOSE THE ONE YOU PREFER!

* Batteries and chargers NOT INCLUDED in the tools.



LI-ION BATTERIES

- POWER INDICATOR**
- SHORT CIRCUIT PROTECTION**
- OVER HEATING PROTECTION**
- OVER CHARGING PROTECTION**

60012	60013	60015	60026
0.45 - 5 920 	0.75 - 5 700 	1.00 - 20 630 	0.20 5 40 1400
48,00€	80,00€	138,00€	379,0€

CHARGERS

-
-
- POWER INDICATOR**
- SHORT CIRCUIT PROTECTION**
- OVER HEATING PROTECTION**
- OVER CHARGING PROTECTION**

60016	60017	60025
0.80 - 5 210 	0.80 - 5 290 	0.30 5 4 700
49,00€	64,00€	31,60€

ACCESSORIES



REF.	DESCRIPTION	mm						€
14622	TRAY FOR REF.60001, 60003, 60004, 60020	320x180	A	0.95	-	10	360	17,00€
14623	HOOK FOR REF.60005, 60006, 60018	70x84	B	0.10	-	10	800	8,00€
14624	TRAY FOR REF.60007, 60010, 60011	290x160	C	0.65	-	10	300	17,00€
14625	HANGER FOR REF.60008, 60009	40x200x100	D	0.50	-	10	700	14,00€
14626	HOOK FOR REF.60023	115x70	E	0.10	-	10	-	7,00€
16364	HOOK WITH ONE LONG TIP 280MM	280		0.20	-	200	-	3,50€

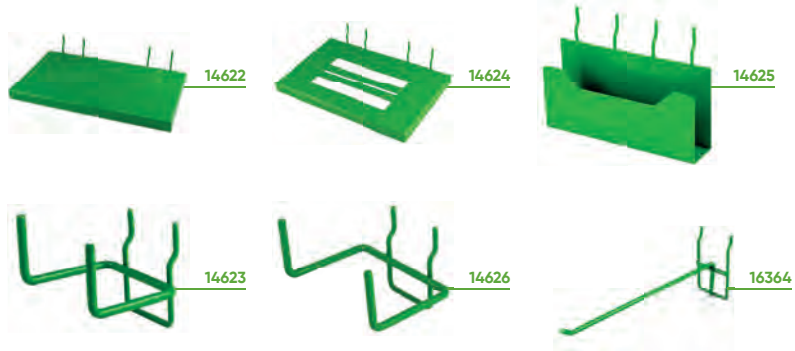

SPARE PARTS



SDS-PLUS CHISELS

REF.	DESCRIPTION				€
14837	SDS-PLUS CHISEL POINT 14X250MM	0.25	10	100	3,30€
14838	SDS-PLUS STRAIGHT CHISEL 20X250MM	0.25	10	100	3,40€
14839	SDS-PLUS FLAT CHISEL 40X250MM	0.29	10	50	4,70€
14840	SDS-PLUS GROOVE CHISEL 250MM	0.27	10	50	3,35€



53850 14,90€

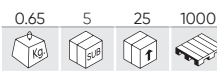

7 PIECES SDS PLUS HAMMER DRILL BIT SET



SPARE PARTS AVAILABLE

REF.	mm				€
14826	Ø 5x110mm	0.05	125	500	1,50€
14828	Ø 6x110mm	0.05	25	500	1,50€
14829	Ø 6x160mm	0.04	25	500	1,50€
14830	Ø 8x110mm	0.04	25	500	1,50€
14831	Ø 8x160mm	0.05	25	500	1,50€
14832	Ø 10x160mm	0.05	25	200	2,00€
14920	Ø 12x160mm	0.10	100	200	2,50€

YOU MAY ALSO LIKE...

REF.	mm				€
14825	Ø 4x110mm	0.05	100	200	1,50€
14827	Ø 5x160mm	0.04	25	500	2,00€
14833	Ø 10x210mm	0.10	20	200	2,05€
14834	Ø 12x210mm	0.10	100	200	2,50€
14835	Ø 14x210mm	0.10	20	125	3,00€
14836	Ø 16x210mm	0.14	20	120	3,50€



POWER TOOLS CORDLESS

14841

2,58€

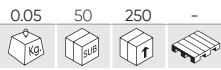

ADAPTER SDS PLUS TO DRILL CHUCK
ADAPTOR 1/2"



14842

9,50€

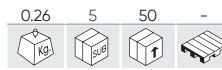

2-13MM 1/2"-20UNF KEYLESS DRILL CHUCK



53860

3,65€



MASONRY DRILL BIT SET 4-10MM



SPARE PARTS AVAILABLE

REF.	mm				€
14908	Ø 4x75mm	0.01	50	100	0,60€
14909	Ø 5x80mm	0.01	50	100	0,80€
14910	Ø 6x100mm	0.01	50	100	1,00€
14912	Ø 8x120mm	0.05	50	100	1,55€
14914	Ø 10x120mm	0.04	20	100	2,10€

YOU MAY ALSO LIKE...

REF.	mm				€
14915	Ø 11x150mm	0.05	20	100	2,65€
14916	Ø 12x150mm	0.06	20	100	2,95€
14917	Ø 13x150mm	0.10	20	100	3,45€



53861

5,45€

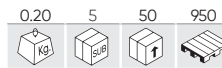

MASONRY DRILL BIT SET 3-10MM



SPARE PARTS AVAILABLE

REF.	mm				€
14907	Ø 3x60mm	0.01	50	100	0,50€
14908	Ø 4x75mm	0.01	50	100	0,60€
14909	Ø 5x80mm	0.01	50	100	0,80€
14910	Ø 6x100mm	0.01	50	100	1,00€
14911	Ø 7x100mm	0.01	50	100	1,30€
14912	Ø 8x120mm	0.05	50	100	1,55€
14913	Ø 9x120mm	0.05	50	100	1,90€
14914	Ø 10x120mm	0.04	20	100	2,10€



53859

67,00€

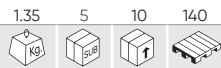

BI-METAL HOLE SAW SET WITH ADAPTERS



	x6	22, 29, 35, 44, 51, 68mm
	x2	14-30mm, 32-152mm



SPARE PARTS AVAILABLE

REF.	mm				€
14901	22mm	0.04	10	50	3,60€
14902	29mm	0.08	10	50	4,65€
14903	35mm	0.10	10	50	5,25€
14904	44mm	0.12	10	50	6,85€
14905	51mm	0.12	10	50	8,50€
14906	68mm	0.19	10	50	10,20€
14934	14-30mm	0.07	10	50	4,25€
14935	32-152mm	0.20	10	50	8,45€

METRIC HSS 4341 TWIST DRILL SET

53852 207,00€

4.20 - 4 192

170 PCS HSS-G 4341

METAL 1-10 mm



53856 62,00€

1.32 5 10 550

25 PCS HSS-G 4341

METAL 1-13 mm



53854 27,00€

0.63 5 20 192

19 PCS HSS-G 4341

METAL 1-10 mm



SPARE PARTS AVAILABLE

REF.	mm				€
14868	Ø 1x34mm	0.01	50	400	0,55€
14869	Ø 1.5x40mm	0.01	50	400	0,60€
14870	Ø 2x49mm	0.01	50	400	1,00€
14871	Ø 2.5x57mm	0.01	50	400	1,00€
14872	Ø 3x61mm	0.01	50	400	1,00€
14873	Ø 3.5x70mm	0.01	50	400	1,00€
14874	Ø 4x75mm	0.01	50	400	1,00€
14875	Ø 4.5x80mm	0.01	50	400	1,50€
14876	Ø 5x86mm	0.01	50	300	1,50€
14877	Ø 5.5x93mm	0.02	50	300	1,50€
14878	Ø 6x93mm	0.02	25	400	2,00€
14879	Ø 6.5x101mm	0.02	25	400	2,00€
14880	Ø 7x109mm	0.03	25	400	2,50€
14881	Ø 7.5x109mm	0.03	25	400	2,50€
14882	Ø 8x117mm	0.04	25	400	3,00€
14883	Ø 8.5x117mm	0.04	25	400	3,50€
14884	Ø 9x125mm	0.05	25	400	4,00€
14885	Ø 9.5x125mm	0.05	25	400	4,00€
14886	Ø 10x133mm	0.06	25	400	4,60€
14887	Ø 10.5x133mm	0.07	25	400	5,00€
14888	Ø 11x142mm	0.08	25	400	6,00€
14889	Ø 11.5x142mm	0.09	25	400	6,50€
14890	Ø 12x151mm	0.10	25	300	7,00€
14891	Ø 12.5x151mm	0.09	25	200	7,50€
14892	Ø 13x151mm	0.09	25	200	8,00€

1x34, 1.5x40, 2x49, 2.5x57, 3x61, 3.5x70, 4x75, 4.5x80, 5x86, 5.5x93, 6x93, 6.5x101, 7x109, 7.5x109, 8x117, 8.5x117, 9x125, 9.5x125, 10x133mm

1x34, 1.5x40, 2x49, 2.5x57, 3x61, 3.5x70, 4x75, 4.5x80, 5x86, 5.5x93, 6x93, 6.5x101, 7x109, 7.5x109, 8x117, 8.5x117, 9x125, 9.5x125, 10x133, 10.5x133, 11x142, 11.5x142, 12x151, 12.5x151, 13x151mm

1x34, 1.5x40, 2x49, 2.5x57, 3x61, 3.5x70, 4x75, 4.5x80, 5x86, 5.5x93, 6x93, 6.5x101, 7x109, 7.5x109, 8x117, 8.5x117, 9x125, 9.5x125, 10x133mm

HSS 4241 TWIST DRILL SET BLACK

53851 88,00€

3.80 - 4 192

170 PCS HSS-G 4241

METAL 1-10 mm



53855 24,80€

1.19 5 10 192

25 PCS HSS-G 4241

METAL 1-13 mm



53853 14,40€

0.58 5 20 192

19 PCS HSS-G 4241

METAL 1-10 mm



SPARE PARTS AVAILABLE

REF.	mm				€
14843	Ø 1x34mm	0.01	50	400	0,50€
14844	Ø 1.5x40mm	0.01	50	400	0,50€
14845	Ø 2x49mm	0.01	50	400	0,50€
14846	Ø 2.5x57mm	0.01	50	400	0,50€
14847	Ø 3x61mm	0.01	50	400	0,50€
14848	Ø 3.5x70mm	0.01	50	400	0,50€
14849	Ø 4x75mm	0.01	50	400	1,00€
14850	Ø 4.5x80mm	0.01	50	400	1,00€
14851	Ø 5x86mm	0.01	50	300	1,00€
14852	Ø 5.5x93mm	0.01	50	300	1,00€
14853	Ø 6x93mm	0.02	25	400	1,00€
14854	Ø 6.5x101mm	0.02	25	400	1,00€
14855	Ø 7x109mm	0.02	25	400	1,00€
14856	Ø 7.5x109mm	0.03	25	400	1,00€
14857	Ø 8x117mm	0.03	25	400	1,50€
14858	Ø 8.5x117mm	0.04	25	400	1,50€
14859	Ø 9x125mm	0.04	25	400	1,50€
14860	Ø 9.5x125mm	0.05	25	400	2,00€
14861	Ø 10x133mm	0.05	25	400	2,00€
14862	Ø 10.5x133mm	0.06	25	400	2,00€
14863	Ø 11x142mm	0.07	25	400	2,50€
14864	Ø 11.5x142mm	0.07	25	400	2,50€
14865	Ø 12x151mm	0.08	25	300	2,50€
14866	Ø 12.5x151mm	0.09	25	200	3,00€
14867	Ø 13x151mm	0.09	25	200	3,00€

1x34, 1.5x40, 2x49, 2.5x57, 3x61, 3.5x70, 4x75, 4.5x80, 5x86, 5.5x93, 6x93, 6.5x101, 7x109, 7.5x109, 8x117, 8.5x117, 9x125, 9.5x125, 10x133mm

1x34, 1.5x40, 2x49, 2.5x57, 3x61, 3.5x70, 4x75, 4.5x80, 5x86, 5.5x93, 6x93, 6.5x101, 7x109, 7.5x109, 8x117, 8.5x117, 9x125, 9.5x125, 10x133, 10.5x133, 11x142, 11.5x142, 12x151, 12.5x151, 13x151mm

1x34, 1.5x40, 2x49, 2.5x57, 3x61, 3.5x70, 4x75, 4.5x80, 5x86, 5.5x93, 6x93, 6.5x101, 7x109, 7.5x109, 8x117, 8.5x117, 9x125, 9.5x125, 10x133mm

SET OF TWIST DRILLS HSS-CO5 COBALT

N

54348 291,00€



170 PCS HSS CO5
METAL 1-10 mm

54314 82,00€

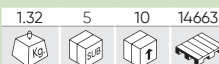

25 PCS HSS CO5
METAL 1-13 mm

54313 43,00€



19 PCS HSS CO5
METAL 1-10 mm

SPARE PARTS AVAILABLE

REF.	mm				€
16318	∅ 1x34mm	0.50	25	400	0,50€
16319	∅ 1.5x40mm	0.50	25	400	0,50€
16320	∅ 2x49mm	0.50	25	400	0,50€
16321	∅ 2.5x57mm	0.50	25	400	1,00€
16322	∅ 3x61mm	0.50	25	400	1,00€
16323	∅ 3.5x70mm	0.50	25	400	1,00€
16324	∅ 4x75mm	0.05	25	400	1,50€
16325	∅ 4.5x80mm	0.50	25	400	1,50€
16326	∅ 5x86mm	0.50	25	400	2,00€
16327	∅ 5.5x93mm	0.50	25	400	2,00€
16328	∅ 6x93mm	0.50	25	400	2,50€
16329	∅ 6.5x101mm	0.50	25	400	3,00€
16330	∅ 7x109mm	0.50	25	400	3,50€
16331	∅ 7.5x109mm	0.50	25	400	3,50€
16332	∅ 8x117mm	0.50	25	400	4,00€
16333	∅ 8.5x117mm	0.05	5	200	4,50€
16334	∅ 9x125mm	0.50	25	200	5,50€
16335	∅ 9.5x125mm	0.50	25	200	6,00€
16336	∅ 10x133mm	0.50	25	200	6,50€
16583	∅ 10.5x133mm	0.07	25	200	8,50€
16584	∅ 11x142mm	0.07	25	200	10,50€
16585	∅ 11.5x142mm	0.08	25	200	11,50€
16586	∅ 12x151mm	0.10	25	200	13,00€
16587	∅ 12.5x151mm	0.10	25	200	14,00€
16588	∅ 13x151mm	0.11	25	200	15,00€



1x34, 1.5x40, 2x49, 2.5x57, 3x61, 3.5x70, 4x75, 4.5x80, 5x86, 5.5x93, 6x93, 6.5x101, 7x109, 7.5x109, 8x117, 8.5x117, 9x125, 9.5x125, 10x133mm

1x34, 1.5x40, 2x49, 2.5x57, 3x61, 3.5x70, 4x75, 4.5x80, 5x86, 5.5x93, 6x93, 6.5x101, 7x109, 7.5x109, 8x117, 8.5x117, 9x125, 9.5x125, 10x133, 10.5x133, 11x142, 11.5x142, 12x151, 12.5x151, 13x151mm

1x34, 1.5x40, 2x49, 2.5x57, 3x61, 3.5x70, 4x75, 4.5x80, 5x86, 5.5x93, 6x93, 6.5x101, 7x109, 7.5x109, 8x117, 8.5x117, 9x125, 9.5x125, 10x133mm

53857 27,00€

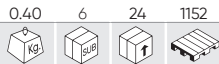

QUICK CHANGE DRILL BIT ADAPTOR SET - BLACK FINISH

57 PCS S2



IN 6 UNITS DISPLAY CASE



IT INCLUDES

	x9	PH	25mm	1x3, 2x3, 3x3
	x9	PZ	25mm	1x3, 2x3, 3x3
	x4	H	25mm	3, 4, 5, 6
	x6	SL	25mm	4x2, 5x2, 6x2
	x14	TX	25mm	10x2, 15x2, 20x2, 25x2, 27x2, 30x2, 40x2
	x7	T	25mm	10, 15, 20, 25, 27, 30, 40
	x7		65mm	PH2, PH3, PZ1, PZ2, T20, T25, SL6
	x1		60mm	

* ALSO SUITABLE FOR REF. 60005

53858 28,80€

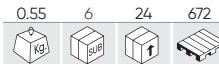

DRILL BIT ADAPTER SET S2 - BLACK FINISH

33 PCS S2



IN 6 UNITS DISPLAY CASE



IT INCLUDES

	x4	PH	25mm	1, 2x2, 3
	x3	PZ	25mm	1, 2, 3
	x4	H	25mm	3, 4, 5, 6
	x4	SL	25mm	3, 4, 5, 6
	x6	TX	25mm	10, 15, 20, 25, 30, 40
	x6		75mm	T15, T20, T25, PH2, PZ2, SL5
	x4		48mm	6, 7, 8, 10mm
	x1		60mm	
	x1		80mm	

* ALSO SUITABLE FOR REF. 60005

54346

11,50€

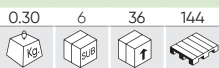

N

SET OF 3 PCS CLEANING BRUSHES FOR DRILL

3 PCS PP 1/4"

- A Ø 88mm
- B Ø 100mm
- C Ø 50mm



60037

18 GA BRAD NAIL SET

REF.	mm				€
53999	25x1,25mm	0.20	-	50	2,00€
54000	30x1,25mm	0.25	-	50	2,50€
54002	38x1,25mm	0.30	-	50	3,00€

1000 PCS

18 GA NARROW CROWN STAPLE SET

REF.	mm				€
54008	25x6mm	0.45	-	40	3,50€
54010	32x6mm	0.55	-	40	4,50€
54011	38x6mm	0.65	-	40	5,00€

1000 PCS



60028
60049C

15014

20,00€



M14 115-230 mm

M14 ANGLE GRINDER QUICK CHANGE FAST LOCKING NUT



POWER TOOLS CORDLESS

FOR METAL

REF.	FOR	DESCRIPTION					€
14893	60008	T42 - 115x2,5mm	0.05	50	100	-	2,00€
14894	60028	T42 - 125x2,5mm	0.05	50	200	-	1,20€
14895	60008	T27 - 115x6mm	0.15	25	100	-	1,90€
14896	60028	T27 - 125x6mm	0.78	25	100	-	2,10€

FOR STAINLESS STEEL

REF.	FOR	DESCRIPTION					€
14897	60008	T41 - 115x1mm	0.01	50	400	-	0,88€
14898	60028	T41 - 125x1mm	0.03	50	400	-	0,98€
14899	60008	T41 - 115x1,6mm	0.03	50	400	-	0,88€
14900	60028	T41 - 125x1,6mm	0.04	50	400	-	0,98€



14893

T27	80 m/s	13300 RPM
	Ø115mm	Ø22,23mm



14894

T42	80 m/s	12200 RPM
	Ø125mm	Ø22,23mm



14897

T41	80 m/s	13300 RPM
	Ø115mm	Ø22,23mm



14898

T41	80 m/s	12200 RPM
	Ø125mm	Ø22,23mm



14895

T42	80 m/s	13300 RPM
	Ø115mm	Ø22,23mm



14896

T27	80 m/s	12200 RPM
	Ø125mm	Ø22,23mm



14899

T41	80 m/s	13300 RPM
	Ø115mm	Ø22,23mm



14900

T41	80 m/s	12200 RPM
	Ø125mm	Ø22,23mm



FOR METAL (STAINLESS STEEL, ALUMINUM, COOPER)

REF.	FOR	DESCRIPTION					€
14988	60007	24T 165mm	0.25	20	40	2400	8,00€
14989	60011	24T 115mm	0.10	20	100	3600	6,00€
14990	60022	40T 185mm	0.30	20	40	2200	10,50€
14993	60010	T118A	0.05	20	200	7200	5,00€
14995	60019	150mm 24TPI	0.05	20	200	8400	8,00€

FOR WOOD

REF.	FOR	DESCRIPTION					€
14985	60007	24T 165mm	0.25	20	40	2400	6,00€
14986	60011	24T 115mm	0.10	20	100	3600	4,00€
14987	60022	40T 185mm	0.30	20	40	2200	8,50€
14991	60010	T244D	0.05	20	200	7200	2,00€
14994	60019	150mm 6TPI	0.05	20	200	8400	3,50€



14989

	x24	7000 RPM
	Ø115mm	Ø10mm



14988

	x24	7000 RPM
	Ø165mm	Ø20mm



14990

	x40	7000 RPM
	Ø185mm	Ø25,4mm



14955

	24TPI	10mm CORTE PARA MSA CUT
150mm		



14994

	6TPI	150mm CORTE PARA MSA CUT
150mm		



14991

	T244D	100mm CORTE PARA MSA CUT
100mm		



14993

	T118A	8mm CORTE PARA MSA CUT
76mm		



14986

	x24	7000 RPM
	Ø115mm	Ø10mm



14985

	x24	7000 RPM
	Ø165mm	Ø20mm



14987

	x40	7000 RPM
	Ø185mm	Ø25,4mm

LIGHTING

- 130 INSPECTION LAMPS
- 132 HEAD TORCHES
- 134 LED MAGNIFYING LAMP
- 135 FLOOD LED
- 136 BONNET LIGHTING
- 137 BEACONS
- 139 LED WORK LAMP
- 142 SIGNALLING
- 144 ACCESSORIES AND SPARE PARTS

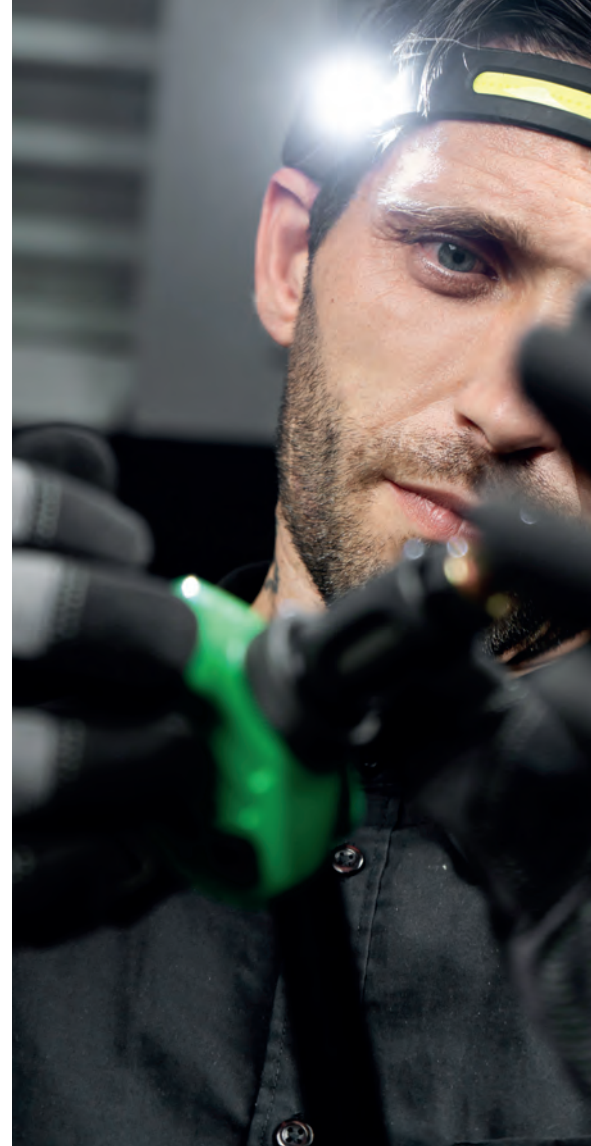

53734

23,70€

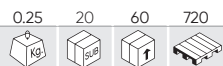

COB LED RECHARGEABLE INSPECTION LIGHT- 400LM



ROTATING BASE MAGNETIZED 360° LIGHT INTENSITY SELECTOR USB CHARGER WITH HANGER

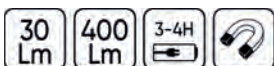

LED COB 400Lm - 2,5H LED COB 30Lm - 10H LI-ION 3.7V 2.600mah



IN 20 UNITS DISPLAY CASE



380mm 32mm

53519

42,00€

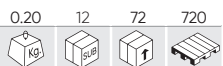

300mm 38mm 12mm

ULTRA SLIM COB LED RECHARGEABLE INSPECTION LIGHT



150Lm - 4H 300Lm - 2H

LI-POLI 3.7V 800mA LED 3W COB

100V 240V 50-60 Hz 6500± 400 KELVIN

IP 44 68-71 ICR 5V 0.6A



IN 12 UNITS DISPLAY CASE

52536

57,00€



360mm 50mm

SLIM COB LED RECHARGEABLE INSPECTION LIGHT



INTENSITY 1 3H INTENSITY 2 4H

LITHIUM 3.7V 1.900mA LED 2W COB



DISEÑO REGISTRADO REGISTERED DESIGN



51889

49,00€

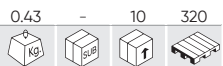

255mm 56mm

RECHARGEABLE INSPECTION LIGHT WITH DOUBLE BACK MAGNET AND IN THE FOLDABLE BASE



80Lm - 5H LED 24+6 LITHIUM 3.7V 2200mah



53216

49,00€

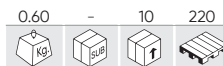

390mm 100mm

RECHARGEABLE COB LED INSPECTION LIGHT WITH MAGNETIC FOLDABLE BASE



170Lm - 4H LED 2W COB

LITHIUM 3.7V 2.000mA LITHIUM 5V 1000mA



RECHARGEABLE INSPECTION LIGHT WITH MAGNETIC FOLDABLE BASE

54122 38,00€

0.39 12 24 384

300 Lm	3-4H		
LED 3W - 7H	COB 3W - 2,5H		
LITHIUM 3.7V 2.000mA	6500± 400 KELVIN		
IP 44	68-71 ICR	100V 240V	5V 1A

54123 40,00€

0.39 12 24 384

500 Lm	6-7H		
LED 3W - 14H	COB 5W - 3H		
LITHIUM 3.7V 4.000mA	6500± 400 KELVIN		
IP 44	68-71 ICR	100V 240V	5V 1A

54124 47,00€

0.39 12 24 384

1000 Lm	6-8H		
LED 3W - 14H	COB 10W - 3H		
LM 1000 5min	900 30min	700 145min	
LITHIUM 3.7V 4.000mA	6500± 400 KELVIN		
IP 44	68-71 ICR	100V 240V	5V 1A

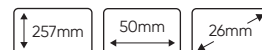

IN 12 UNITS DISPLAY CASE

REF. DESCRIPTION

14031 USB WALL CHARGER ADAPTER

0.10 10 100 1152 7,90€

54379

0.23 12 48 1440

28,00€

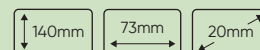

10W COB RECHARGEABLE WORKLIGHT WITH SOLAR

80-800 Lm	5,2V	0,5W	
3,5H	4-12H		BANCO DE ENERGIA POWER BANK
80Lm 3W COB	800Lm 10W COB		
x1 LI-POLI 3.7V - 4000mAh			

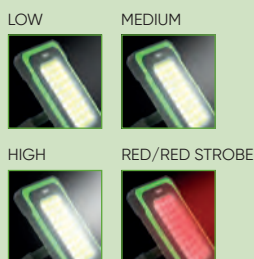

IN 12 UNITS DISPLAY CASE

53776

0.15 12 48 1872

19,10€

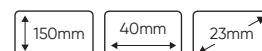

POCKET FLASHLIGHT WITH BATTERY

90 Lm	300 Lm	2,5H	
300Lm 5W COB - 3H	LI-ION 3.7V 1500mah		
250Lm 3W COB - 3,5H	ABS	TPR	
90Lm 3W LED - 6H			



IN 12 UNITS DISPLAY CASE



250LM 3W COB

300LM 5W COB

90LM 3W LED



LIGHTING

54344

10,50€

0,10	10	100	1200

LED HEADLAMP HAT

120 Lm	60 Lm	25 Lm
--------	-------	-------

LM	120 40min	60 6-8h	25 8-10h
----	--------------	------------	-------------

3.7V 250mAh	2H
-------------	----

LUZ DISPERSA SCATTERED LIGHT	1W
---------------------------------	----

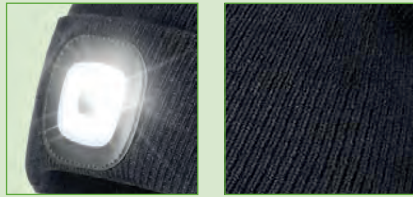

REMOVABLE LIGHT UNIT

POLYESTER (65%)
ACRYLIC (35%)



N

52987

20,00€

0,17	10	40	720

POCKET FLASHLIGHT WITH BATTERY

120 Lm	2,5H
--------	------

120Lm - 2,5H	
--------------	--

LITHIUM 3.7V 1.000mAh	LED 3W COB
--------------------------	---------------



IN 10 UNITS
DISPLAY CASE



160mm	30mm	20mm
-------	------	------



53780

14,50€

0,45	5	20	300

LED TUBE WORK LIGHT 400LM

400 Lm	6W	220V 240V
--------	----	--------------

IP 20	50 Hz
-------	-------

6000± 7000 KELVIN

H05RN-F 2x0.75mm ² - 5m

2,5M
POWER CORD



52384

29,00€

0,33	-	20	600

ULTRA-SLIM COB LED INSPECTION LIGHT

- Cable length: 5m
- DC Cable length: 0.1M
- DC cable length up tongs: 0.3M

200 Lm	12V 24V
--------	------------

LED 3W COB

75mm	325mm	90mm
------	-------	------



53217

47,00€

0,30	-	20	620

FLEXIBLE COB LED WORK LIGHT WITH MAGNETIC BASE

200 Lm	4H
--------	----

LED 2W COB	
---------------	--

LITHIUM 3.7V 2.200mah	LITHIUM 5V 1.000mah
--------------------------	------------------------

45mm	380mm
------	-------



54004

16,00€

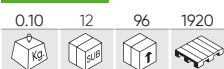

COB HEADLIGHT

COB 350Lm -5W COB	LED 90Lm -3W XPE
COB 350Lm - 2,5H 150Lm - 5 H Flash - 8 H	LED XPE 150Lm - 4H 60Lm - 8 H
LI-ION 3.7V 1.200mA	Gel de sílice Silica gel
2m	IP X4

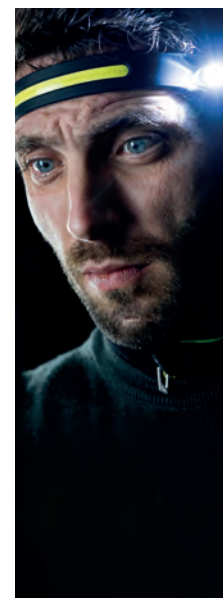

MOTION SENSOR BUTTON

Press to activate.
Press to deactivate.
Pass your hand in front of the button to turn the light on and off.

- Material: Silica gel.
- Power indicator, induction indicator.
- Motion sensor activation mode.
- USB charging cable included.



IN 12 UNITS DISPLAY CASE



53569

18,00€



HEADLIGHT 800LM (COB + CREE)

- FOCUS REGULATOR
- 3 LIGHT MODES
- RECHARGEABLE BATTERIES
- "LIGHT ON" INDICATOR



MAX 800 Lm	2,5H	150m
LED COB + CREE	x2 18650	
High Low Flash COB		



53568

12,00€

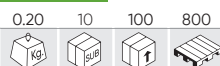

HEADLIGHT 350LM

- FOCUS REGULATOR
- 3 LIGHT MODES

MAX 350 Lm	2,5H	150m
High Low Flash SOS		
LI-ION 2000mAh		



54267

9,50€

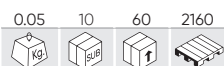

GLOVE WITH LED LIGHT

70 Lm	120 mAh	+20H
LED	DERECHA RIGHT	
x2 CR2016 INCLUIDAS / INCLUDED		
x2 LED 3.0V		



LIGHTING

53974

38,00€

0.75 5 20 240

RECHARGEABLE LED WORK LIGHT

1500 Lm
 5-6H 100% 50%
 2.5H 6H
 LED 20W COB ABS
 100% 50% SOS FLASH

4 LIGHTING MODES
 100% 50% SOS FLASH



MULTI-POSITION



37mm 240mm 225mm

52555

2,38€

0.03 48 192 3456

9 LED PLASTIC FLASHLIGHT



27 Lm x9 LED x3 AAA
 30mm 93mm IN 12 UNITS DISPLAY CASE

51326

4,40€

0.07 12 144 2880

21 LED FLASHLIGHT



63 Lm x21 LED x3 AAA
 95mm 35mm IN 12 UNITS DISPLAY CASE

BATTERIES

REF.	DESCRIPTION					€	
51258	"AAA" R03 1,5V	0.01	60	2400	134400	0,15€	

FOR REF. 51326, 52233, 52555, 52558

REF.	DESCRIPTION					€
10923	9V	0.05	10	500	-	1,10€

FOR REF. 52162, 52450, 51929, 50942



53427

5,00€

0.05 12 96 3456

6-LED MAGNETIC PEW FLASHLIGHT



IN 12 UNITS DISPLAY CASE

45 Lm x6 LED x3 AAA



51573

2,50€

0.07 12 96 3168

2 LED DYNAMO FLASHLIGHT



6 Lm x2 LED

PRESENTATION IN INDIVIDUAL BOX



53227 28,00€



DESKTOP LED MAGNIFYING LAMP

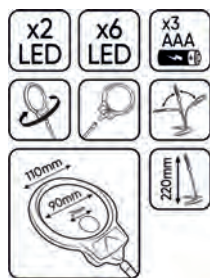

53085 30,00€



8 LED MAGNIFYING GLASS

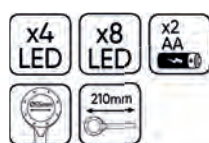

TRIPOD FOR LED FLOOD LIGHT

REF.	Max.	Min.	kg	sub	units	€
53506	1830mm	840mm	2.40	-	8	36,00€
52254	2770mm	1290mm	3.51	-	4	64,00€



53505 77,00€



50W LED FLOOD LIGHT



54039 154,00€



LED HIGH BAY LIGHT

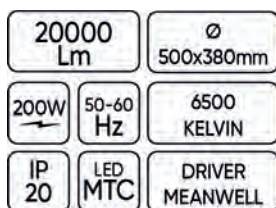

54133 547,00€



6 PIECES LED HIGH BAY LIGHT SET 54039



REF.	DESCRIPTION	kg	sub	units	€	
15385	SPARE LAMP SHADE FOR REF.54039	0.15	6	60	600	18,00€

54088 132,00€



UFO HIGH BAY LIGHT

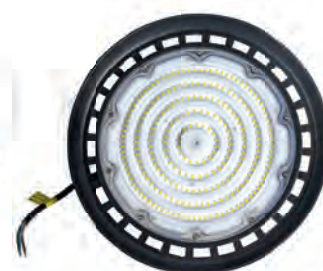
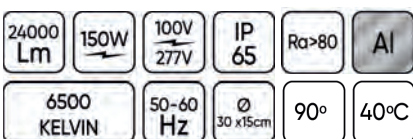

LIGHTING

54270

42,00€

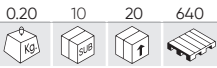

LED LAMP WITH MAGNETIC HOLDER

1000 Lm **3-4H**
LED 1000Lm- 2H **LED 400Lm- 5H**
x2 LI-ION 3.7V - 1200mAh **USB TYPE-C**



54271

54,00€

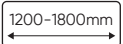
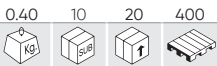

MAGNET LED BAR WITH BONNET STRAP

1000 Lm **3-4H**
LED 1000Lm- 2H **LED 400Lm- 5H**
x2 LI-ION 3.7V - 1200mAh **USB TYPE-C**



ARTICULATED

53707

153,00€

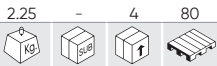

UNDER BONNET MAGNETIC INSPECTION LIGHT

1000 Lm
7-8H **6H** **ABS**
LED 3x5W COB **350Lm** **700Lm** **1000Lm**
x4 LI-ION 3.7V - 2600mAh



3 LIGHT MODES
RECHARGEABLE BATTERY
ILLUMINATED BATTERY STATUS INDICATOR

INCREASE NOTABLY VISIBILITY IN THE WORK AREA
DIRECT LIGHT EXACTLY WHERE YOU NEED IT
WITH MAGNETIC SUPPORT TO ADAPT TO ANY SITUATION



53570

154,00€

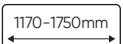
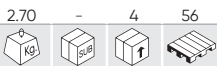

UNDER BONNET INSPECTION LIGHT

1000 Lm
7-8H **6H**
LED 3x5W COB **400Lm** **800Lm** **1200Lm**
x4 LI-ION 3.7V - 2600mAh



3 LIGHT MODES
RECHARGEABLE BATTERY
ILLUMINATED BATTERY STATUS INDICATOR

INCREASE NOTABLY VISIBILITY IN THE WORK AREA
DIRECT LIGHT EXACTLY WHERE YOU NEED IT



54173 87,00€

0.75 5 20 240

RECHARGEABLE LED BEACON MAGNETIC BASE

- FUNCTIONS:
FUNCTION 1: SINGLE FLASH
FUNCTION 2: DOUBLE FLASH
FUNCTION 3: ROTATION

20W 5V x45 LED

PC ABS 2-3H 2-3H

LI-ION 7.4V - 2200mA -30°C 50°C IP 65



REF. DESCRIPTION €

16053 USB CABLE A TYPE / ROUND PLUG 5.5MM 0.05 10 100 2,85€

54172 81,00€

0.80 5 20 240

RECHARGEABLE LED BEACON 9-30V SPIGOT BASE

- FUNCTIONS:
FUNCTION 1: SINGLE FLASH
FUNCTION 2: DOUBLE FLASH
FUNCTION 3: ROTATION

20W 5V x45 LED

PC ABS 2-3H 2-3H

LI-ION 7.4V - 2200mA -30°C 50°C IP 65



REF. DESCRIPTION €

16052 USB CABLE A TYPE / ROUND PLUG 3.5MM 0.05 10 100 2,09€

53691 36,00€

0.70 - 20 320

ROTATING LED BEACON MAGNETIC BASE

- FUNCTIONS:
FUNCTION 1: SINGLE FLASH
FUNCTION 2: DOUBLE FLASH
FUNCTION 3: ROTATION



x8 LED 18W 12V 24V IP 66

112mm 125cm -30°C 50°C

4m PC ECE R10 ECE R65



53690 34,00€

0.55 - 20 200

12-24V LED BEACON FLEXIBLE SPIGOT BASE

- FUNCTIONS:
FUNCTION 1: SINGLE FLASH
FUNCTION 2: DOUBLE FLASH
FUNCTION 3: ROTATION



x8 LED 18W 12V 24V IP 66

182mm 125cm -30°C 50°C

PC ECE R10 ECE R65



52375 38,00€

0.70 - 20 240

FLASH ROTATING LED BEACON 12-24V

- ABS-BAES LENS.
- ANTI SHOCK.
- CABLE: 2,5M WITH LIGHTER PLUG.
- CONSUMPTION: 9W.

- FUNCTIONS:
FUNCTION 1: ROTATION
FUNCTION 2: DOUBLE FLASH
FUNCTION 3: 6 LIGHT

12V 24V 9W

170mm 140cm IP 56

2,5m PC/ABS ECE R10



MAGNETIC BASE

52456 36,00€

0.60 - 20 160

LED BEACON 12-24V FLEXIBLE SPIGOT BASE

- PC LENS.
- ANTI SHOCK.
- CONSUMPTION: 8W.

- FUNCTIONS:
FUNCTION 1: ROTATION
FUNCTION 2: DOUBLE FLASH
FUNCTION 3: 6 LIGHT

12V 24V 8W PC/ABS

240mm 128cm IP 56



ABS - BAES FLEXIBLE BASE

LIGHTING

51964

28,00€

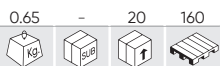

ROTATING BEACON H1 12V 55W SPIGOT BASE



Anti-shock
PC lens
Lens thread with durable seal
RPM: 40
Pinion/worm system
Bulb H1, 12V 55W
With threaded base
Current consumption: 3.0 Amp



**ABS - BAES
FLEXIBLE BASE**

51965

29,50€

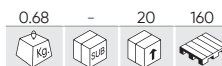

ROTATING BEACON H1 24V 70W SPIGOT BASE



Anti-shock
PC lens
Lens thread with durable seal
RPM: 40
Pinion/worm system
Bulb H1, 24V 70W
With threaded base
Current consumption: 3.0 Amp



**ABS - BAES
FLEXIBLE BASE**

51962

25,00€



ROTATING BEACON WITHOUT CABLE H1 12V 55W



Anti-shock
ABS - BAES lens
Lens thread with durable seal
RPM: 40
Pinion/worm system
Bulb H1, 12V 55W
Current consumption: 3.0 Amp



51963

29,00€

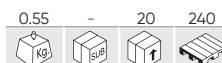

ROTATING BEACON CORDLESS H1 24V 70W



Anti-shock
ABS - BAES lens
Lens thread with durable seal
RPM: 40
Pinion/worm system
Bulb H1, 24V 70W
Current consumption: 3.0 Amp



51960

34,00€

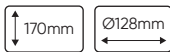

MAGNETIC BASE ROTATING BEACON WITH COILED CABLE H1 12V-55W

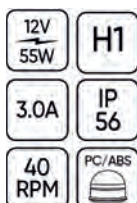

ABS - BAES lens
Lens thread with durable seal
RPM: 40
Pinion/worm system
Bulb H1, 12V 55W
Cable:
4 m spiral with cigarette lighter plug
Current consumption: 3.0 Amp



51961

34,00€

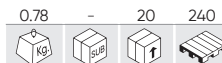

ROTATING BEACON WITH MAGNETIZED CABLE H1 24V 70W



ABS - BAES lens
Lens thread with durable seal
RPM: 40
Pinion/worm system
Bulb H1, 24V 70W
Cable:
4 m spiral with cigarette lighter plug
Current consumption: 3.0 Amp



LOW PROFILE LED FLASHING ROTATING BEACON

REF.						€
52827		0.50	-	20	400	46,00€
52828		0.54	-	20	320	43,00€
52910		0.50	-	20	320	39,00€

- 3 FUNCTION SWITCHES.
- 3 FLASHING MODES:
ROTATING
6 FLASHING
DUAL FLASH



51966

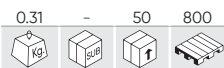

18,00€

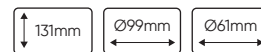

FLASHING BEACON 12V-110V



- ABS - BAES lens.
- XENON.
- Current consumption: 3.0 A.



THREADED TULIP-SHAPED BASE

ACCESSORIES FOR TOOL TROLLEYS

REF.	DESCRIPTION					€
11103	ROTATING BEACON LAMP FOR 51966	0.01	-	100	-	6,00€
10766	SPARE LAMP FOR 51960, 51962	0.01	-	200	-	1,59€
10750	POLE CONNECTORS FOR ROTATION BEACON REF. 51964, 51965, 52456	0.25	-	50	-	13,00€
10751	POLE CONNECTOR FOR ROTATION BEACON REF. 51964, 51965, 52300 AND 52456	0.30	-	50	-	15,00€
52843	EXTENDABLE BAR FOR ROTATING BEACON	0.90	-	20	1500	31,60€
51969	BEACON REPLACEMENT AMBER LENS FOR REF. 51960, 51961, 51964	0.12	-	50	1000	14,00€
11324	BEACON REPLACEMENT BLUE LENS FOR REF. 51960, 51961, 51964	0.13	-	100	-	17,50€
11325	BEACON REPLACEMENT RED LENS FOR REF. 51960, 51961, 51964	0.12	-	50	451	17,50€



LED WORK LIGHT SCATTERED LIGHT

53428

18,00€

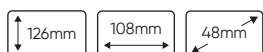
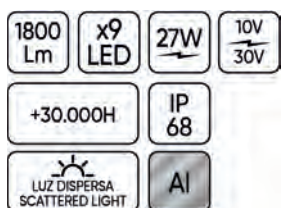
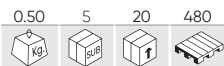

53429

18,00€

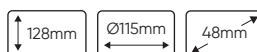
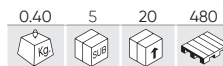

LIGHTING

52566

28,00€

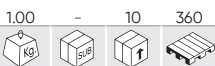

1450 Lm x9 LED 27W 10V/40V
 +30.000H IP 68
 LUZ DISPERSA SCATTERED LIGHT AI



52567

29,00€

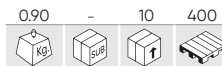

1450 Lm x9 LED 27W 10V/40V
 +30.000H IP 68
 LUZ DISPERSA SCATTERED LIGHT AI

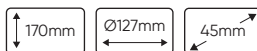

52302

25,40€

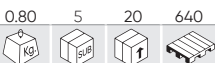

1450 Lm x9 LED 27W 10V/40V
 +30.000H IP 68
 LUZ DISPERSA SCATTERED LIGHT AI

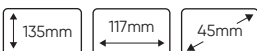

52303

26,40€

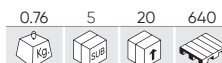

1450 Lm x9 LED 27W 10V/40V
 +30.000H IP 68
 LUZ DISPERSA SCATTERED LIGHT AI



53049

89,00€



3600 Lm x4 LED 40W 9V/36V
 +30.000H IP 68
 LUZ DISPERSA SCATTERED LIGHT AI



53052

158,00€



7200 Lm x8 LED 80W 9V/36V
 +30.000H IP 68
 LUZ DISPERSA SCATTERED LIGHT AI

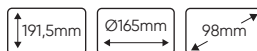

53045

35,00€

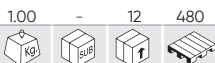

2800 Lm x16 LED 48W 10V/40V
 +20.000H IP 67
 LUZ DISPERSA SCATTERED LIGHT AI



53046

39,00€



2272 Lm x16 LED 24W 9V/36V
 +20.000H IP 68
 LUZ DISPERSA SCATTERED LIGHT AI



LED WORK LIGHT SPOTLIGHT

52568 28,00€

0.75 - 10 400



1450 Lm x9 LED 27W 10V/30V

+30.000H IP 68

LUZ CONCENTRADA SPOTLIGHT AI



165mm 117mm 45mm

52569 28,00€

0.70 5 20 320



1450 Lm x9 LED 27W 10V/30V

+30.000H IP 68

LUZ CONCENTRADA SPOTLIGHT AI



170mm Ø127mm 45mm

53048 89,00€

1.50 - 10 1000



3600 Lm x4 LED 40W 9V/36V

+30.000H IP 68

LUZ CONCENTRADA SPOTLIGHT AI



118mm 123mm 87mm

53051 158,00€

2.75 - 6 468



7200 Lm x8 LED 80W 9V/36V

+30.000H IP 68

LUZ CONCENTRADA SPOTLIGHT AI



191,5mm Ø165mm 98mm

52415 19,00€

0.60 5 20 640



1450 Lm x9 LED 27W 10V/40V

+30.000H IP 68

LUZ CONCENTRADA SPOTLIGHT AI



127mm 110mm 50mm

52414 19,00€

0.55 5 20 600



1450 Lm x9 LED 27W 10V/40V

+30.000H IP 68

LUZ CONCENTRADA SPOTLIGHT AI



127mm Ø110mm 55mm

53047 330,00€

3.51 - 4 40



3200 Lm x10 LED 50W 12V/24V

6500 KELVIN 280cm IP 67

LUZ CONCENTRADA SPOTLIGHT AI

ROTARY

ADJUSTABLE SPEED OF MOVEMENT

REMOTE DISTANCE 100M





230mm 185mm 150mm

LIGHTING

54161

90,00€



TRAILER BOARD METAL 1.4-2.1M TELESCOPIC

DYNAMIC LIGHTS



REGULATION	HOMOLOGATION NUMBER
3	E9*3R02/17*23444*00
4	E9*4R00/19*23444*00
6	E9*6R01/29*23444*00
7	E9*7R02/27*23444*00
10	E9*10R06/00*22232*02

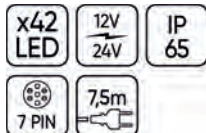

54163

80,00€



RING TRAILER LIGHTING BOARD WITH REAR LIGHTS AND 2 TRIANGULAR REFLECTORS

DYNAMIC LIGHTS

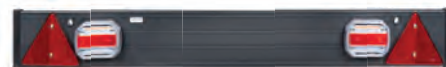

REGULATION	HOMOLOGATION NUMBER
3	E9*3R02/17*23444*00
4	E9*4R00/19*23444*00
6	E9*6R01/29*23444*00
7	E9*7R02/27*23444*00
10	E9*10R06/00*22232*02

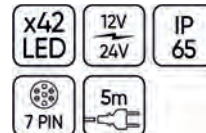

50910

45,00€



TRAILER TOWING BAR WITH 2 REAR LIGHTS AN 2 TRIANGULAR REFLECTORS 1100X140MM



REGULATION	HOMOLOGATION NUMBER
4	E4*4R-0024080
6	E4*6R-0124080
7	E4*7R-0224080
10	E9*10R06/02*23498*00



52838

56,00€

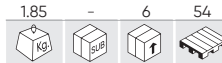

TRAILER TOWING BAR WITH 2 REAR LIGHTS AN 2 TRIANGULAR REFLECTORS 1100X140MM



HOMOLOGATION NUMBER
E4*7R-0218756



MAGNETIC REAR LIGHTS AND TRIANGULAR REFLECTORS SET

PLAIN CABLE: 7,5M
SPIRAL CABLE: 2,5M

54162

81,00€



HOMOLOGATION NUMBER
E9*7R02/27*23444*00

DYNAMIC LIGHTS



51886

44,00€



REGULATION	HOMOLOGATION NUMBER
3	E4*3R-023749
4	E4*4R-0024080
6	E4*6R-0124080
7	E4*7R-0224080
10	E9*10R06/02*23498*00

52839

64,00€

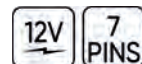

REGULATION	HOMOLOGATION NUMBER
3	E4*3R-0218756
4	E4*4R-0018756
6	E4*6R-0118756
7	E4*7R-0218756
10	E9*10R06/02*23199*01

54044 99,00€

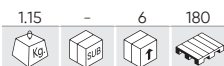

SET OF 2 WIRELESS MAGNETIC LED REAR LIGHTS



HOMOLOGATION NUMBER

E9*10R05/01*16210*02

53151 14,00€

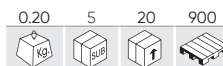

REAR LIGHT FOR TOWING LIGHT BAR



- 4 functions:
- Blue: Position and registration.
- Red: Brake light.
- Yellow: Slide direction indicator.
- White: Mass.

LED LIGHT FOR TOWING LIGHT BAR

REF.					€
54160L	LEFT	0.20	5	20	17,50€
54160R	RIGHT	0.20	5	20	17,50€

- 4 functions:
- Black: Position and registration.
- Red: Brake light.
- Green: Slide direction indicator.
- White: Mass.

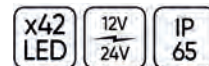

HOMOLOGATION NUMBER

E9*7R02/27*23444*00

E9*10R06/01*23199*00

DYNAMIC LIGHTS



53536 34,00€

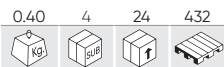

TOWLINE LIGHT TESTER 7/13 POLE



REF. DESCRIPTION

REF.	DESCRIPTION				€
14753	7-PIN EXTENSION FOR REF. 53536	0.20	-	50	13,00€

51929 22,00€

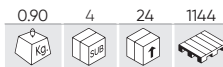

TOWLINE LIGHT TESTER 7 POLE



TOWAGE INLET

VEHICLE OUTLET

LIGHTING

ACOUSTIC ALARM 12V-80V

REF.	DB	IP	V	°C				€
51967	97DB	IP65	12V-80V	-30/70°C	0.20	50	1200	16,00€
51968	107DB	IP65	12V-80V	-30/70°C	0.23	50	1000	16,00€



- Resistant to different climatic conditions.
- Can be washed with pressurized water.
- Protected from inverse polarities.
- Sealed with epoxy resins.



51967



51968

54078

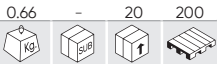

68,00€

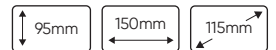

FORKLIFT SAFETY LIGHT

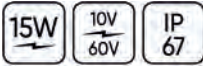

Oval security light with 2 blue LEDs. The light is projected on the ground with a blue concentrated light as a warning for pedestrians in the area.

This warning light allows to avoid collisions and accidents between forklifts and people, and increases safety in work environments, especially in blind spots. Perfect for noisy environments.



CIGARETTE LIGHTERS AND VOLTAGE CONVERTER

REF.	DESCRIPTION					€
10961	CHARGER FOR REF. 51889 AND 52257	0.08	-	50	-	13,00€
11107	CIGARETTE LIGHTER PLUG FOR REF 51889	0.06	-	250	-	4,50€
11989	CIGARETTE LIGHTER PLUG FOR REF. 52536	0.04	-	200	-	2,00€
13839	USB ADAPTOR PLUG 110V/60HZ	0.04	-	200	-	8,50€
14031	USB WALL CHARGER ADAPTER	0.10	10	100	1152	7,90€
14032	USB CIGARETTE LIGHTER ADAPTER	0.10	10	100	1200	12,00€
14033	USB CABLE TYPE A / MICRO-B	0.10	10	100	500	4,50€
16052	USB CABLE A TYPE / ROUND PLUG 3.5MM	0.05	10	100	-	2,09€
16053	USB CABLE A TYPE / ROUND PLUG 5.5MM	0.05	10	100	-	2,85€



10961



11107



11989



13839



14031



14032



14033



16052

16053

PNEUMATIC TOOLS

- 147 SCREWDRIVING
- 151 DRILLING
- 152 CUTTING / SAWING
- 153 SANDING/POLISHING
- 156 AIR BLOW GUNS
- 158 TYRE MAINTENANCE
- 160 OTHER
- 163 AIR HOSE REEL
- 165 CONNECTOR HOSES
- 166 ACCESSORIES AND CONSUMABLES





JBM RECOMMENDS THE USE OF ITS LUBRICANT OILS TO OPTIMIZE PERFORMANCE AND EXTEND LIFESPAN OF AIR TOOLS

REF.14534 REF.14560

PAGE 161

53520

228,00€

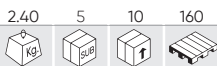

AIR IMPACT WRENCH 1/2" (1756NM) - COMPOSITE



COMPOSITE
1756Nm

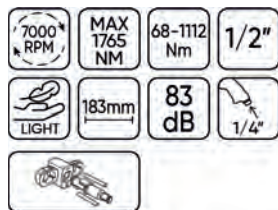

REF. DESCRIPTION

14121 AIR TOOL REPAIR KIT FOR - 51207 / 53520 0.75 - 20 26,00€

51207

289,00€

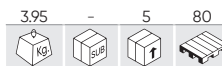

1/2" COMPOSITE IMPACT GUN SET + SOCKETS



COMPOSITE
1756Nm

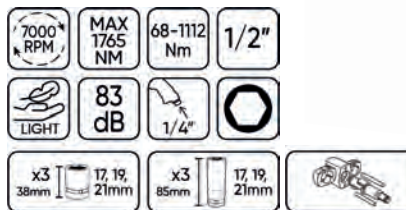

REF. DESCRIPTION

14121 AIR TOOL REPAIR KIT FOR - 51207 / 53520 0.75 - 20 26,00€

51206

228,00€

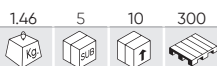

MINI AIR IMPACT WRENCH 1/2" COMPOSITE



COMPOSITE
1302Nm

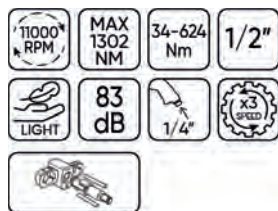

REF. DESCRIPTION

14120 AIR TOOL REPAIR KIT FOR 51206 0.15 - 5 22,00€

53588

178,00€

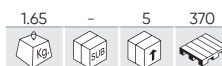

NANO AIR IMPACT WRENCH 1/2" (1302NM)



1302Nm

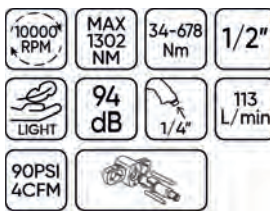

REF. DESCRIPTION

14165 AIR TOOL REPAIR KIT FOR 53588 0.05 - 20 26,50€

JBM RECOMMENDS THE USE OF ITS LUBRICANT OILS TO OPTIMIZE PERFORMANCE AND EXTEND LIFESPAN OF AIR TOOLS

REF.14534 REF.14560

PAGE 161



53733 238,00€

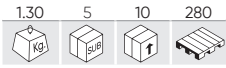

ANGLE IMPACT WRENCH 1/2"



650Nm

8500 RPM	8500 RPM 350Nm	8500 RPM 650Nm	X4 SPEED
MAX 650 NM	27-231 Nm	1/2"	1/4"
113 L/min	90PSI 4CFM	LIGHT	88mm

REF.	DESCRIPTION	kg	L	cm	mm	€
14633	AIR TOOL REPAIR KIT FOR - 53733	0.03	-	20		22,50€

54340 296,00€



N

1/2" ARTICULATED IMPACT WRENCH



813 Nm

8000 RPM	MAX 813 NM	1/2"
1/4"	210 L/min	4m/seg
90 PSI	8 CFM	6,2 BAR
		92 dB

REF.	DESCRIPTION	kg	L	cm	mm	€
16341	AIR TOOL REPAIR KIT FOR 54340	0.07	-	15		32,50€

54397 249,00€

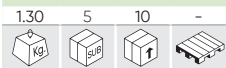

N

1/2" AIR PALM IMPACT WRENCH



1004Nm

7500 RPM	MAX 1004 NM	1/2"	1/4"
6.3 BAR	90 PSI	8.4 CFM	764(m/s²)
92,9 dB(Lp)	103,9 dB(Lw)	96 L/min	
141mm	85mm	64mm	

REF.	DESCRIPTION	kg	L	cm	mm	€
16564	AIR TOOL REPAIR KIT FOR 54397	0.10	-	20		17,00€

53689 238,00€

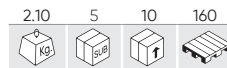

AIR IMPACT WRENCH 1/2" (1950NM) - COMPOSITE



COMPOSITE 1950Nm

8600 RPM	MAX 1950 NM	95-936 Nm	1/2"
169mm	1/4"	X4 SPEED	90PSI 4CFM

REF.	DESCRIPTION	kg	L	cm	mm	€
14618	AIR TOOL REPAIR KIT FOR 53689	0.01	-	20		19,00€

PNEUMATIC TOOLS

53608

98,00€

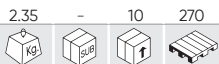

IMPACT WRENCH 1/2" 1200NM

1200Nm

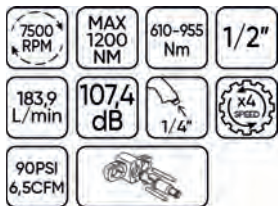

REF. DESCRIPTION



14583 AIR TOOL REPAIR KIT - 53608 0.01 - 20 6,00€

53726

128,00€

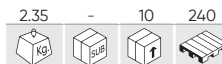

IMPACT WRENCH 1/2" 1650NM

1650Nm

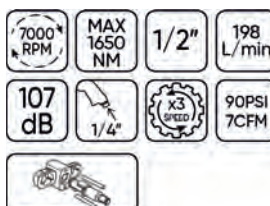

REF. DESCRIPTION



15564 AIR TOOL REPAIR KIT - 53726 0.05 - - 11,90€

51212

488,00€



AIR IMPACT WRENCH 3/4" COMPOSITE

2034Nm

COMPOSITE



REF. DESCRIPTION



14122 AIR TOOL REPAIR KIT FOR 51210 / 51212 1.12 - 50 34,00€

51211

560,00€



AIR IMPACT WRENCH 1" COMPOSITE

2034Nm

COMPOSITE

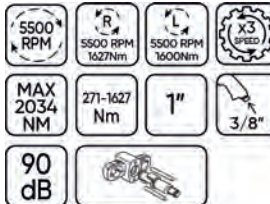

REF. DESCRIPTION



14123 AIR TOOL REPAIR KIT FOR 51211 / 51213 1.16 - 20 33,00€

51210

650,00€



AIR IMPACT WRENCH 3/4" + LONG ANVIL 15CM

2034Nm

COMPOSITE

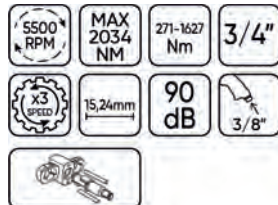

REF. DESCRIPTION



14122 AIR TOOL REPAIR KIT FOR 51210 / 51212 1.12 - 50 34,00€

51213

690,00€



AIR IMPACT WRENCH 1" WITH 19 CM EXTENDER

2034Nm

COMPOSITE

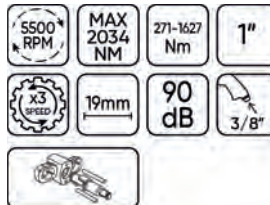

REF. DESCRIPTION



14123 AIR TOOL REPAIR KIT FOR 51211 / 51213 1.16 - 20 33,00€

53681 743,00€

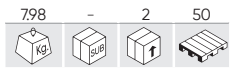

1" LIGHT WEIGHT LONG NOSE AIR IMPACT WRENCH FOR TRUCKS



2441Nm



REF. DESCRIPTION	kg	Box	Pallet	€
14336 AIR TOOL REPAIR KIT FOR 53681	1.17	10	10	58,00€

52814 528,00€

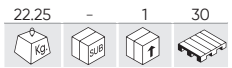

1" LIGHT WEIGHT AIR IMPACT WRENCH SPECIAL FOR TRUCKS 3260NM



3260Nm



REF. DESCRIPTION	kg	Box	Pallet	€
14153 AIR TOOL REPAIR KIT FOR 52814	0.05	-	15	20,50€

53343 285,00€

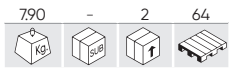

IMPACT WRENCH 3/4"

1600Nm

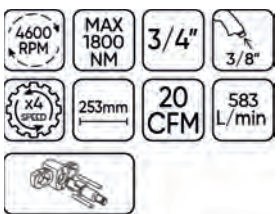

51222 128,00€

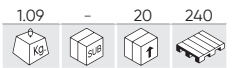

IMPACT WRENCH 1/2"

101Nm



REF. DESCRIPTION	kg	Box	Pallet	€
14131 AIR TOOL REPAIR KIT FOR 51222	0.01	-	10	24,00€

52156 140,00€

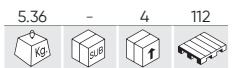

16 PIECES AIR WRENCH AND RATCHET SET

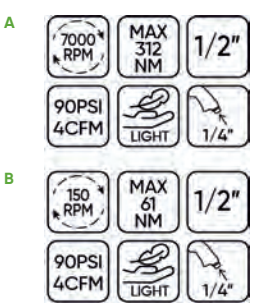

x10 9, 10, 11, 13, 14, 17, 19, 22, 24, 27mm

52165 118,00€

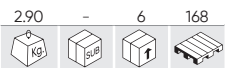

AIR IMPACT WRENCH 1/2"

680Nm



54336

259,00€



N

1/2" PNEUMATIC ARTICULATED RATCHET WRENCH

95Nm



REF. DESCRIPTION

16273 AIR TOOL REPAIR KIT FOR 54336

0.15 - 15 12,50€

51214

148,00€

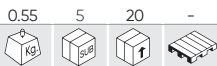

1/4" MINI AIR RATCHET COMPOSITE

40,7Nm

COMPOSITE



REF. DESCRIPTION

14124 AIR TOOL REPAIR KIT FOR - 51214

0.25 - 10 20,50€

51215

119,00€

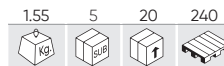

1/2" AIR RATCHET

14-68Nm



REF. DESCRIPTION

14125 AIR TOOL REPAIR KIT FOR 51215

0.03 - 10 19,50€

52167

48,00€

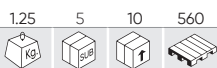

1/2" AIR RATCHET

61Nm



53784

148,00€



1/2" STUBBY RATCHET COMPOSITE

40,8Nm

COMPOSITE



REF. DESCRIPTION

14779 AIR TOOL REPAIR KIT FOR 53784

0.05 - 10 33,00€

51221 199,00€



90° ANGLED DRILL



REF. DESCRIPTION €

14130 AIR TOOL REPAIR KIT FOR 51221 0.40 - 10 21,00€

51220 240,00€



REVERSIBLE DRILL COMPOSITE



REF. DESCRIPTION €

14129 AIR TOOL REPAIR KIT FOR 51220 0.01 - 10 12,50€

53573 36,00€



3/8" STRAIGHT AIR DRILL



52527 82,00€



REVERSIBLE RIGHT ANGLE AIR PNEUMATIC DRILL 3/8" 90°



52159 64,00€

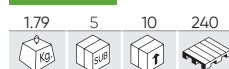

REVERSIBLE AIR DRILL 1/2"



52160 48,00€



REVERSIBLE AIR DRILL 3/8"



PNEUMATIC SPOT-WELD DRILL WITH DISPLACEMENT DRILL

52724 381,00€



REF. DESCRIPTION €

13817 6.5 MM SPOTWELD DRILL BIT FOR REF.52725 0.10 - 500 17,00€

52725 349,00€



REF. DESCRIPTION €

13818 8 MM SPOTWELD DRILL BIT FOR REF.52725 0.10 - 500 20,50€

52718

48,00€

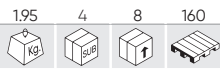

9 PIECES AIR CHISEL SET



- A 21mm
- B 1,8mm
- C 21mm
- D 21mm



52953

38,00€

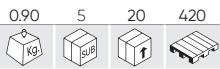

3" CUT-OFF TOOL



REF.	DESCRIPTION	kg	Sub	Units	€
12987	DISK FOR TYRE CUT OFF TOOL 3" (52953)	0.02	50	500	1,50€

53140

98,00€

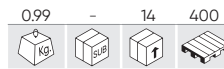

3" LONG REACH AIR CUT-OFF TOOL



REF.	DESCRIPTION	kg	Sub	Units	€
14013	SPARE DISC FOR REF. 53140	0.01	-	1000	3,50€

53541

168,00€

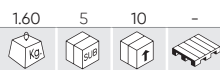

AIR POWER SHEAR



REF.	DESCRIPTION	kg	Sub	Units	€
14136	AIR TOOL REPAIR KIT FOR 53541	0.01	-	5	12,00€

52574

69,00€



AIR RECIPROCATING SAW



REF.	DESCRIPTION	kg	Sub	Units	€
11956	24 TEETH REPLACEMENT SAW FOR WOOD	0.03	10	300	5,50€
11957	32 TEETH REPLACEMENT SAW FOR IRON	0.01	10	250	5,50€

51216

650,00€

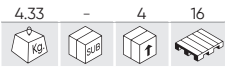

AIR SURFACE PREPARATION TOOL SET



ACCESSORIES

REF.	DESCRIPTION				€
51388	ANGLED BRUSH 23MM FOR 51216	0.10	100	800	22,00€
51389	ANGLED BRUSH 11MM FOR REF. 51216	0.05	1	800	22,00€
51390	23 MM FINE FLAT BRUSH FOR 51216	0.05	100	800	22,00€
51391	11 MM FINE BRUSH FOR 51216	0.04	1	800	22,00€
51392	PAINT SCRAPING BRUSH FOR 51216	0.20	100	800	34,00€
51393	WATER PAINT SCRAPING BRUSH FOR 51216	0.10	50	800	34,00€
51439	ADAPTER FOR 23MM WHEEL W/TOR	0.10	100	800	26,00€
51440	ADAPTER FOR 11MM WHEEL W/TOR	0.10	1	800	28,00€
51441	ADAPTER FOR DOUBLE BLACK WHEEL W/TOR + W	0.10	1	800	26,00€
51442	ADAPTER F/SIMPLE BLACK WHEEL	0.10	50	800	28,00€
REF.	DESCRIPTION				€
14126	AIR TOOL REPAIR KIT FOR 51216	0.01	-	10	54,00€

IT INCLUDES

- Different types of wheels (For preparation of metal surfaces)
- 11 mm wire brush (fine)
- 23 mm wire brush (fine)
- 11 mm wire brush (thick)
- 23 mm wire brush (thick)
- Rubber remover
- Water base paint remover
- 23 mm adapter for rubber remover and wire brush
- 11 mm wire brush adapter
- Black rubber polisher (up to 6 pieces)
- Rubber polisher single adapter
- Double strip rubber adapter

53576

189,00€

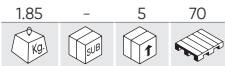

3" MINI AIR POLISHER KIT



REF.	DESCRIPTION				€
A	14162 WOOL PAD FOR ITEM 53576	0.05	-	50	25,50€
B	14163 SPONGE SOFT PAD FOR ITEM 53576 - WHITE	0.50	5	50	25,50€
C	14164 SPONGE HARD PAD FOR ITEM 53576 - YELLOW	0.50	5	50	25,50€
D	14330 VELCRO DISK FOR ITEM 53576	0.01	5	50	3,50€
14154	AIR TOOL REPAIR KIT FOR - 53576	0.05	-	10	42,00€

53646

69,00€

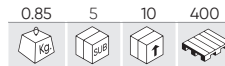

3" AIR POLISHER KIT



REF.	DESCRIPTION				€
A	14286 SPONGE SOFT PAD FOR ITEM 53646	0.01	10	200	2,99€
B	14287 SPONGE HARD PAD FOR ITEM 53646	0.00	10	200	2,99€
C	14288 WOOL PAD FOR ITEM 53646	0.01	10	200	6,00€
D	14289 VELCRO DISK FOR ITEM 53646	0.04	-	200	6,10€

53626

18,00€

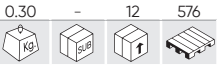

HEADLIGHT RESTORATION SET

14 PCS

IT INCLUDES

- x2 P800 Sanding Discs
- x2 P1200 Sanding Discs
- x2 P2000 Sanding Discs
- x2 3.0ml UV Protect Liquid
- x2 Adapter (3/8" & 1/4")
- x1 85gm Polish Paste
- x1 Masking tape
- x1 Wool Polish Disc
- x1 White Sponge Disc



IN 12 UNITS DISPLAY CASE

SERIE262

199,00€

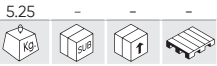

POLISHING KIT: 3" AIR POLISHER + 12 HEADLIGHTS RESTORATION KITS

53626

53646

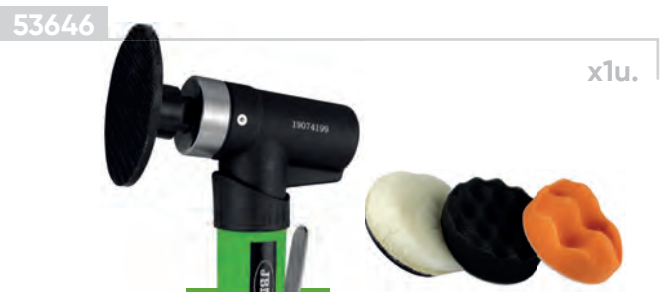

52676

98,00€

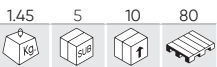

AIR ORBITAL SANDER SELF-CONTAINED DUST

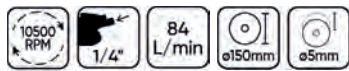

- Aluminium body with rubber grip.
- With tube and aspiration bag.



52675

84,00€

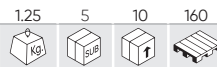

AIR ORBITAL SANDER WITH VACUUM ADAPTER



52758

88,00€

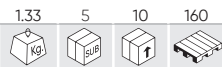

AIR ORBITAL SANDER WITH VACUUM ADAPTER



51226

233,00€

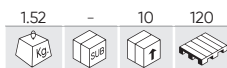

MINI AIR SANDER SET

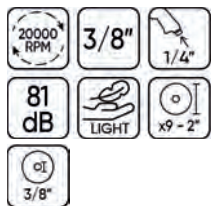

REF. DESCRIPTION

14133 AIR TOOL REPAIR KIT FOR 51226

0.01	-	10	16,50€
------	---	----	--------

52157

48,00€

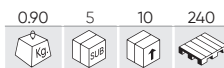

16 PIECES AIR DIE GRINDER SET



51245

99,00€



3/8" COMPACT AIR DIE GRINDER 6MM



REF. DESCRIPTION

14135 AIR TOOL REPAIR KIT FOR 51245

0.01	-	10	12,50€
------	---	----	--------

52171

39,00€



MINI AIR DIE GRINDER 1/4"



53141

68,00€

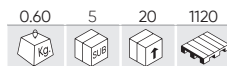

1/4" 90° AIR DIE GRINDER



52528

49,00€

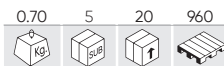

90° AIR ANGLE GRINDER



53137

38,00€

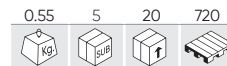

1/4" COMPACT AIR DIE GRINDER



51218

288,00€

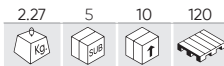

ORBITAL GRINDER COMPOSITE

COMPOSITE



REF. DESCRIPTION

14127 AIR TOOL REPAIR KIT FOR 51218

0.01	-	10	32,50€
------	---	----	--------

PNEUMATIC TOOLS

54255

68,00€

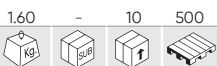

SET OF ACCESSORIES FOR GREASE GUN

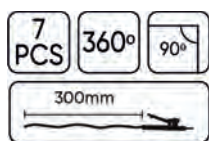

50751

43,00€

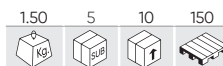

PNEUMATIC GREASE GUN

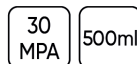

52490

6,65€

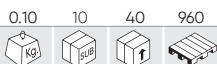

LONG AIR BLOW GUN 100MM

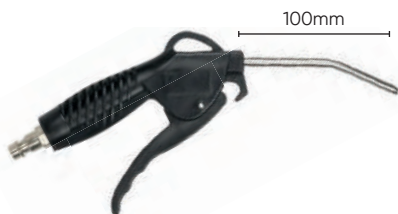

IN 10 UNITS DISPLAY CASE

52491

10,50€



AIR BLOW GUN 300MM



IN 10 UNITS DISPLAY CASE

53611

27,50€



EXTRA LONG AIR BLOW GUN



BIG AIR VOLUME

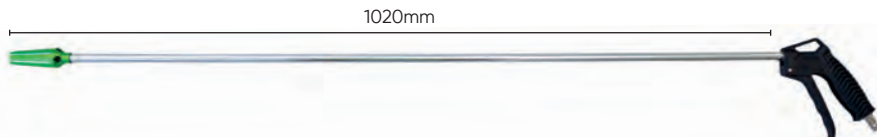

52798

18,00€

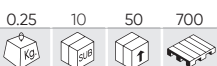

EXTENDABLE LONG LANCE AIR BLOW GUN

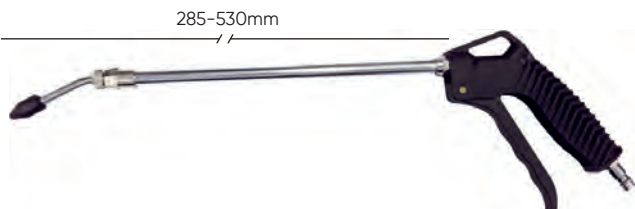

RUBBERIZED TIP TO AVOID SCRATCHES

51980

15,00€



GUN GRIP TYRE INFLATOR



51981 21,50€



AIR BLOW GUN + GUN GRIP TYRE INFLATOR



51277 64,00€



PNEUMATIC TOOLS SET



52787 9,00€

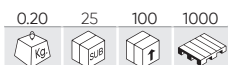

BLOWGUN IN INDIVIDUAL BLISTER



51383 11,10€

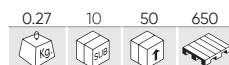

AIR BLOW GUN IN A BLISTER

- Air gun.
- Rapid European connection.
- Hose connection.
- 10cm tube extender.
- 20cm tube extender.



IN 10 UNITS
DISPLAY CASE



54251 43,00€



SUCTION AND BLOW GUN



IT INCLUDES



53205 19,00€

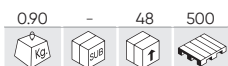

AIR BLOW GUN



BIG AIR VOLUME

- Air blow gun with big air volume nozzle.
- Body material: Aluminum-alloy.
- Surface: Nickel-plating.

52381 20,50€



AIR BLOW GUN 3/8" WITH RECOIL HOSES 5M

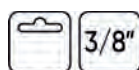

PNEUMATIC TOOLS

54248

58,00€

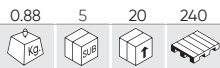

AIR SPRAY GUN

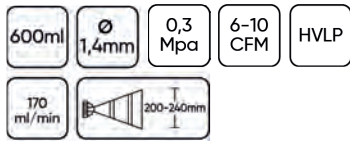

SPARE PARTS AVAILABLE

54249

103,00€

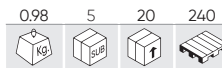

PROFESSIONAL AIR SPRAY GUN



SPARE PARTS AVAILABLE

53606

55,00€

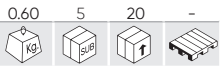

AIR DRYING GUN



AIR REGULATING VALVE



53449

16,40€

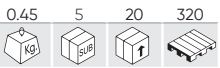

IN-LINE TYRE INFLATOR

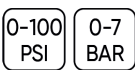

53450

28,30€

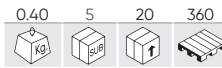

AIR INFLATOR WITH DIGITAL GAUGE



52648

9,00€



TYRE PRESSURE GAUGE



4,3 BAR

53416

14,10€



TYRE GAUGE WITH HOSE (0-10BAR)



0-10 BAR

53417

26,30€



DIGITAL TYRE GAUGE WITH HOSE (0-15BAR)

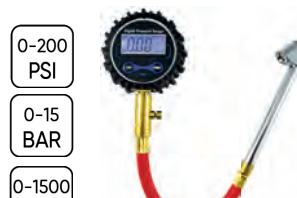

0-200 PSI
0-15 BAR
0-1500 KPA

53418

16,90€

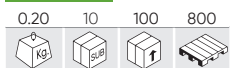

DIGITAL TYRE GAUGE (0-15BAR)

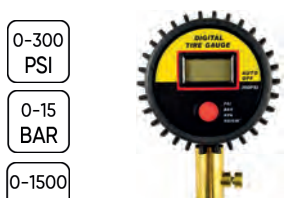

0-300 PSI
0-15 BAR
0-1500 KPA

51861 199,00€

4.00 - 2 32

PNEUMATIC CV JOINT EXPANDER

- Material: Aluminum.
- Aperture 20 to 100mm.

125 PSI 9 BAR

53542 980,00€

6.35 - 4 40

PNEUMATIC TYRE BEAD BREAKER

REF.	DESCRIPTION					€
14137	AIR TOOL REPAIR KIT FOR 53542	0.65	5	5		131,00€

52540 221,00€

4.36 - 1 72

PNEUMATIC SUCTION CUP DENT PULLER

160 L/min 70-110 PSI

620mm
ø 75mm
ø 100mm
ø 125mm

52331 201,00€

790 - 2 48

AIR TOOLS SET

AIR IMPACT WRENCH + AIR HUMMER + AIR RACHET + MINI AIR GRINDER + AIR GUN + STRAIGHT AIR GUN + ACCESSORIES



PNEUMATIC TOOLS

52543

182,00€

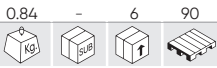

DPF FILTER CLEANING KIT

- Universal.
- Maximum capacity 650cc.
- Nylon hose 4x6x2.7m.
- Work pressure range: 3 bar - 7 bar.
- Aluminum body long duration warranty.



REF.	DESCRIPTION	Kg	Sub	Qty	Price	
90003	DESCARBONIZER	1.08	-	12	400	35,20€
90004	NEUTRALIZING	0.50	-	12	320	25,80€

53625

68,00€

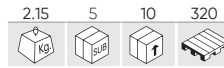

AIR NEEDLE SCALER



REF.	DESCRIPTION	Kg	Sub	Qty	Price
14188	NEEDLE FOR REF. 53625	0.01	50	500	0,50€

53593

41,00€

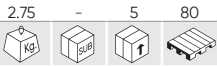

AIR SAND BLASTER GUN



- IT INCLUDES**
- 1x Air sand blasting gun.
 - 1x Blasting catcher.
 - 2x Blasting sand bottles.

- 4x Caps: Point blasting cap, Surface blasting cap, Blasting cap for outside corners, Blasting cap for inside corners.

REF.	DESCRIPTION	Kg	Sub	Qty	Price
14168	SAND BOTTLE (FOR REF.53593)	0.95	-	20	7,00€

53202

15,70€

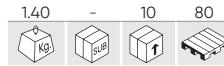

ENGINE WASHING GUN



- Engine cleaning gun.
- Pot material: Steel.
- Body material: Aluminum-alloy.
- Body surface: Powder painting.

53204

81,00€

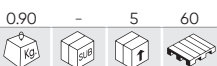

BLACK CLEANING GUN



- Car cleaning gun.
- Pot material: PE.
- Body material: Aluminum-alloy.
- Body surface: Polished.

52575

119,00€



AIR RIVETER

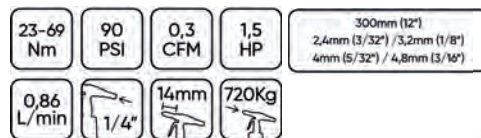

53567

43,00€

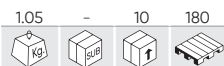

AIR CAULKING GUN



- Working pressure: 2,5-5 BAR.
- Air inlet: 1/4 ".
- Cartridge capacity: 310ml.

52533

10,00€

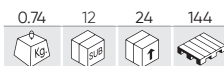

SILICONE CAULKING GUN 300ML

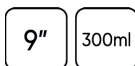

53572

348,00€



AIR VALVE LAPPER SET - PERCUSSION AND ROTATION

CONTENTS

- 1x Valve Lapper.
- 5x Suction Pads (16, 20, 30, 35 and 40 mm).
- 5x Valve Stem Adaptors.
- 1x 3 mm Allen Key.



54033

49,00€

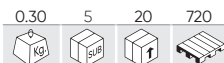

VALVE LAPPING TOOL FOR DRILL

- Suction pad diameter: 16, 20, 30, 35, 40mm
- Drill connection: 8mm
- Length: 128mm
- Maximum working speed: 1250rpm



REF.	mm	Kg	L	mm	€
14157	16	0.01	-	50	8,30€
14158	20	0.01	-	50	9,95€
14159	30	0.01	-	50	12,60€
14160	35	0.01	-	50	12,80€
14161	40	0.10	-	50	13,70€



REF.	mm	Kg	L	mm	€
14157	16	0.01	-	50	8,30€
14158	20	0.01	-	50	9,95€
14159	30	0.01	-	50	12,60€
14160	35	0.01	-	50	12,80€
14161	40	0.10	-	50	13,70€



14534

16,50€



AIR TOOL OIL - 600ML

- Relative density at 15°C: 0,845.
- Viscosity: 12,1 cSt at 40°C.
- Color: Colorless.



14560

8,80€



OIL FOR AIR TOOLS - 100ML

- Relative density at 15°C: 0,845.
- Viscosity: 12,1 cSt at 40°C.
- Color: Colorless.



PNEUMATIC TOOLS



CUTTING DISCS

REF.	DESCRIPTION					€
51385	4" X 1/32" CUTTING DISC FOR REF. 51219	0.01	10	300	800	4,55€
51387	3" CUTTING DISC	0.03	10	300	800	3,25€



SANDING DISCS

REF.	DESCRIPTION					€
51386	5" SANDING DISC FOR REF. 51218	0.10	-	25	800	5,95€
51443	60" SANDING DISC #60 FOR 51226	0.50	25	150	800	5,50€
51444	SANDING DISC #80 FOR REF. 51226	0.02	-	25	800	5,05€
51445	SANDING DISC #120 FOR REF. 51226	0.02	-	25	800	5,05€



DISKS FOR ORBITAL SANDERS

REF.	DESCRIPTION					€
13499	15 HOLES DISK FOR SANDERS	0.10	-	50	1500	12,50€
13500	66 HOLE POLISHING DISC BASE	0.65	5	50	-	12,90€
12009	6 HOLES DISK FOR SANDERS	0.14	-	50	-	11,00€



OIL FILTER AND REGULATOR

REF.	"					€
53063	1/4"	0.60	5	50	300	36,70€
53064	3/8"	0.63	5	50	300	37,40€
53065	1/2"	0.60	5	50	300	36,90€



AIR FILTER, REGULATOR & OIL LUBRICATOR

REF.	"					€
53066	1/4"	1.08	5	25	250	61,00€
53067	3/8"	0.50	5	25	250	61,00€
53068	1/2"	1.00	5	25	250	63,00€



53492

380,00€

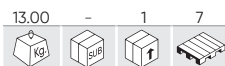

AIR TOOL DISPLAY STAND



TOOLS NOT INCLUDED



52378

10,00€

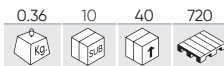

MAGNETIC HOOKS FOR PNEUMATIC TOOLS



53147

41,00€

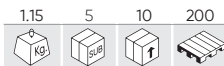

AIR TOOL DISPLAY STAND



TOOLS NOT INCLUDED

53594

54,00€



25M AIR LINE HOSE - 8MM



HYBRID POLYMER
POLÍMERO HÍBRIDO

- Work pressure: 300PSI / 20bar.
- Breakage pressure: 950PSI / 65bar.
- Work temperature: -40°C / 65°C

- Great flexibility.
- Return to its original form.
- Smooth surface, does not damage paint.
- Very resistant.

Inside diameter: 8mm
External diameter: 13mm

To use with:
REF. 52736 (M8)



53595

61,00€



10MM AIR HOSE - 25M



HYBRID POLYMER
POLÍMERO HÍBRIDO

- Work pressure: 300PSI / 20bar.
- Breakage pressure: 950PSI / 65bar.
- Work temperature: -40°C / 65°C

- Great flexibility.
- Return to its original form.
- Smooth surface, does not damage paint.
- Very resistant.

Inside diameter: 10mm
External diameter: 15mm

To use with:
REF. 52737 (M10)



REF. DESCRIPTION

14169 SET OF 10 CLAMPS 8-16MM

0.10 - 125 - 3,00€

PNEUMATIC TOOLS

RECOIL AIR HOSE

REF.	m			"					€
53629	10m	8mm	5mm	1/4"	0.55	-	6	360	14,30€
53630	15m	8mm	5mm	1/4"	0.65	-	6	240	18,80€
53631	15m	12mm	8mm	1/4"	1.25	-	6	120	33,50€
53632	15m	15mm	10mm	1/4"	2.20	-	6	78	46,00€
53633	15m	15mm	10mm	3/8"	2.10	-	6	78	46,00€
53634	15m	18mm	13mm	1/2"	2.60	-	6	66	63,00€



WITH 360 DEGREE SWIVEL ENDS FOR EASY MOVEMENT AND EASE OF USE

- HOSE MATERIAL: PU.
- THREAD MATERIAL: BRASS.

AIR HOSE REEL



AUTO GUIDE REWIND SYSTEM



WALL BRACKET INCLUDED

14772	8,50€
0.35	20

REF. 53582 / REF. 53583



WALL BRACKET INCLUDED

14771	10,50€
0.35	30

REF. 53532 / REF. 53581

20+2m

REF.	m	"				€
53582	22m	3/8"	10.85	-	14	174,00€
53583	22m	3/8"	10.75	-	14	174,00€



12+1m

REF.	m	"				€
53532	13m	3/8"	6.60	-	30	119,00€
53581	13m	3/8"	6.70	-	30	119,00€



10+1,5m

REF.	m	"				€
53881	11,5m	1/4"	4.50	-	48	79,00€
53882	11,5m	1/4"	4.50	-	48	79,00€



QUICK RELEASE AIR FITTINGS MALE THREADED

REF.	DESCRIPTION					€
14204	EUR - M6 M 1/4"	0.06	50	200	-	1,50€
14205	EUR - M8 M 3/8"	0.06	50	200	-	1,50€
14206	EUR - M10 M 1/2"	0.05	50	200	-	1,50€
14207	US - M6 M 1/4"	0.05	50	200	-	1,50€
14208	US - M8 M 3/8"	0.06	50	200	-	1,50€
14209	US - M10 M 1/2"	0.05	50	200	-	1,50€



SECURITY LOCK QUICK CONNECTOR HOSE CONNECTION

REF.	DESCRIPTION					€
14201	M6	0.10	25	100	-	4,00€
14202	M8	0.10	25	100	-	4,00€
14203	M10	0.10	25	100	-	4,50€



CONNECTOR / THREAD

REF.	DESCRIPTION				€
13930	US MALE QUICK CONNECTOR - 1/4" MALE THREAD	0.01	50	100	1,50€
13932	US MALE QUICK CONNECTOR - 3/8" MALE THREAD	0.10	50	100	2,50€
14076	US MALE QUICK CONNECTOR - 3/8" FEMALE THREAD	0.10	50	100	1,50€
13933	US MALE QUICK CONNECTOR - 1/2" MALE THREAD	0.10	50	100	2,00€
13935	US MALE QUICK CONNECTOR - 1/4" FEMALE THREAD (2 PCS)	0.05	50	100	2,50€
13936	US FEMALE CONNECTOR - 1/4" FEMALE THREAD	0.05	50	100	3,50€
13937	US FEMALE CONNECTOR - 1/4" MALE THREAD	0.05	50	100	4,00€
14078	US FEMALE QUICK CONNECTOR - 3/8" FEMALE THREAD	0.10	50	100	4,00€
14191	US MALE QUICK CONNECTOR - 1/2" FEMALE THREAD	0.05	50	100	2,00€
14193	US FEMALE QUICK CONNECTOR - 1/2" FEMALE THREAD	0.10	50	100	4,00€



REF.	DESCRIPTION				€
13931	EUR MALE CONNECTOR - 1/4" MALE THREAD (2 PCS)	0.05	50	100	2,50€
14075	EUR MALE QUICK CONNECTOR - 3/8" FEMALE THREAD	0.10	50	100	2,00€
13934	EUR MALE CONNECTOR - 1/4" FEMALE THREAD (2 PCS)	0.05	50	100	2,50€
13938	EUR FEMALE CONNECTOR - 1/4" FEMALE THREAD	0.10	50	200	3,50€
13939	EUR FEMALE QUICK CONNECTOR - 1/4" MALE THREAD	0.10	50	100	4,00€
14077	EUR FEMALE QUICK CONNECTOR - 3/8" FEMALE THREAD	0.10	50	100	4,50€
14190	EUR MALE QUICK CONNECTOR - 1/2" FEMALE THREAD	0.05	50	100	2,00€
14192	EUR FEMALE QUICK CONNECTOR - 1/2" FEMALE THREAD	0.10	50	100	4,00€



PNEUMATIC TOOLS

SECURITY LOCK QUICK CONNECTOR

REF.	DESCRIPTION					€
14195	FEMALE - 1/4" MALE THREAD	0.50	25	100	-	4,00€
14196	FEMALE - 3/8" MALE THREAD	0.10	25	100	-	4,00€
14197	FEMALE - 1/2" MALE THREAD	0.10	25	100	-	4,50€
14198	FEMALE - 1/4" FEMALE THREAD	0.10	25	100	-	4,00€
14199	FEMALE - 3/8" FEMALE THREAD	0.10	25	100	-	4,00€
14200	FEMALE - 1/2" FEMALE THREAD	0.10	25	100	-	4,50€



SWIVEL MALE AIR PLUG

REF.	DESCRIPTION					€
14314	EUR 1/4"	0.06	25	100	-	5,00€
14315	US 1/4"	0.06	25	100	-	4,50€



14561

0.05	25	50	-

1/4" OIL COUPLER



8,80€



QUICK RELEASE COUPLING

REF.	DESCRIPTION					€
52735	QUICK RELEASE COUPLING M6	0.05	25	200	4000	4,85€
52736	QUICK RELEASE COUPLING M8	0.10	25	200	4000	5,35€
52737	QUICK RELEASE COUPLING M10	0.10	25	200	4000	5,50€



SWIVEL AIR HOSE CONNECTOR

REF.	DESCRIPTION					€
12988	SWIVEL AIR HOSE CONNECTOR 1/2"	0.15	62	125	-	12,00€
13809	SWIVEL AIR HOSE CONNECTOR 1/4"	0.10	62	250	-	18,50€
13810	SWIVEL AIR HOSE CONNECTOR 3/8"	0.10	62	250	-	20,50€



IMPACT TOOLS

- 168 IMPACT SOCKETS SETS
- 173 SPECIAL TOOLS FOR TYRES
- 174 ADAPTERS
- 176 IMPACT SOCKETS SPARE PARTS
- 177 SPECIAL TOOLS FOR TRUCKS



IMPACT TOOLS

52694

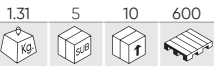

3 PIECE 1/2" XZN IMPACT SOCKET

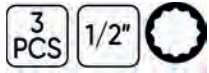

IT CONTAINS



49,00€

52337

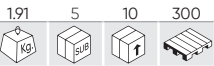

6 PIECE 1/2" HEX IMPACT TOOL SET



IT CONTAINS

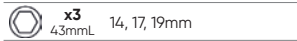

65,00€

52547

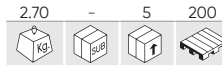

8 PIECE 1/2" XZN IMPACT SOCKET + BITS SET

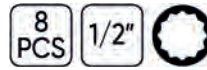

IT CONTAINS

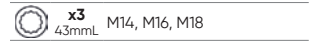

96,00€

52345

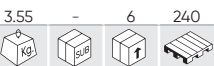

19 PIECE 1/2" IMPACT SOCKETS WITH 14 HEXAGONAL SOCKETS + ADAPTER SET



10, 11, 12, 13, 14, 15, 16, 17, 18, 19, 21, 22, 24, 27mm



SPARE PARTS AVAILABLE

REF.	mm				€
14728	10	0.10	5	20	3,80€
14729	11	0.05	10	100	3,80€
14730	12	0.05	10	100	3,80€
14731	13	0.10	5	20	3,80€
14732	14	0.10	5	20	3,80€
14970	15	0.08	5	20	2,50€
14971	16	0.07	5	20	2,50€

REF.	mm				€
11195	17	0.10	10	100	3,70€
14972	18	0.12	5	20	3,50€
11121	19	0.10	10	60	4,10€
14733	21	0.10	5	20	4,30€
14734	22	0.15	5	20	5,40€
11122	24	0.14	10	20	5,45€
11123	27	0.20	10	50	6,50€

REF.	DESCRIPTION				€
12937	1/2" 50MM DRIVE IMPACT EXTENSION BAR	0.11	10	100	9,50€
14973	150MM EXTENSION BAR 1/2"	0.27	5	20	11,50€
12075	1/2" 250MM DRIVE IMPACT EXTENSION BAR	0.45	10	50	15,50€
11962	IMPACT ADAPTER 1/2" F 3/4" M	0.17	10	100	7,50€
11990	UNIVERSAL JOINT IMPACT SOCKET 1/2"	0.15	10	100	15,30€

109,00€

53531

109,00€

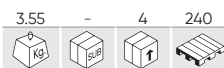

19 PIECE 1/2" IMPACT SOCKETS WITH 14 12-POINTS SOCKETS + ADAPTER SET

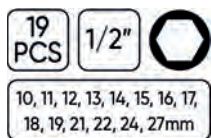

SPARE PARTS AVAILABLE

REF.	DESCRIPTION	kg	10	50	€
12937	1/2" 50MM DRIVE IMPACT EXTENSION BAR	0.11	10	100	9,50€
14973	150MM EXTENSION BAR 1/2"	0.27	5	20	11,50€
12075	1/2" 250MM DRIVE IMPACT EXTENSION BAR	0.45	10	50	15,50€

REF.	DESCRIPTION	kg	10	100	€
11962	IMPACT ADAPTER 1/2" F 3/4" M	0.17	10	100	7,50€
11990	UNIVERSAL JOINT IMPACT SOCKET 1/2"	0.15	10	100	15,30€

52341

58,00€

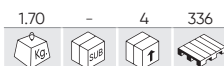

13 PIECE 1/2" HEX IMPACT SOCKET + ADAPTER SET



SPARE PARTS AVAILABLE

REF.	mm	kg	5	20	€
14728	10	0.10	5	20	3,80€
14729	11	0.05	10	100	3,80€
14730	12	0.05	10	100	3,80€
14731	13	0.10	5	20	3,80€
14732	14	0.10	5	20	3,80€

REF.	mm	kg	10	60	€
11195	17	0.10	10	100	3,70€
11121	19	0.10	10	60	4,10€
14733	21	0.10	5	20	4,30€
14734	22	0.15	5	20	5,40€
11122	24	0.14	10	20	5,45€

REF.	DESCRIPTION	kg	5	20	€
14735	1/2" IMPACT BIT HOLDER	0.05	5	20	6,50€
12074	1/2" 125MM DRIVE IMPACT EXTENSION BAR	0.23	10	60	11,50€
11990	UNIVERSAL JOINT IMPACT SOCKET 1/2"	0.15	10	100	15,30€

52346

103,00€



15 PIECE 1/2" HEX DEEP IMPACT SOCKETS SET



SPARE PARTS AVAILABLE

REF.	mm	kg	10	100	€
12061	10	0.14	10	100	9,50€
12062	12	0.15	10	100	9,50€
12063	13	0.15	10	50	9,50€
12064	15	0.17	10	100	9,00€
12065	16	0.30	10	20	9,00€
12066	17	0.20	10	100	9,00€

REF.	mm	kg	10	20 <th>€</th>	€
12067	18	0.22	10	20	9,50€
12068	19	0.21	10	50	9,50€
12069	21	0.25	10	50	9,50€
12070	22	0.27	10	100	10,50€
12071	24	0.30	10	50	11,00€
12072	27	0.36	10	20	12,00€

REF.	DESCRIPTION	kg	10	100	€
12074	1/2" 125MM DRIVE IMPACT EXTENSION BAR	0.23	10	60	11,50€
12075	1/2" 250MM DRIVE IMPACT EXTENSION BAR	0.45	10	50	15,50€
11990	UNIVERSAL JOINT IMPACT SOCKET 1/2"	0.15	10	100	15,30€

53060

34,90€

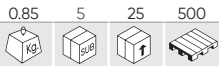

12 PCS LOW PROFILE HEXAGONAL IMPACT SOCKET SET 1/2"

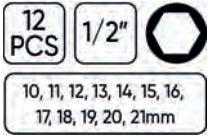

52342

63,00€

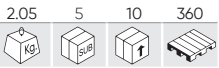

11 PIECE 1/2" HEXAGONAL IMPACT SOCKETS

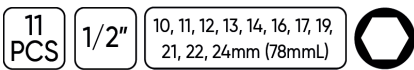

SPARE PARTS AVAILABLE

REF.	mm				€
12061	10	0.14	10	100	9,50€
14736	11	0.15	5	20	5,00€
12062	12	0.15	10	100	9,50€
12063	13	0.15	10	50	9,50€
14737	14	0.15	5	20	5,00€
12065	16	0.30	10	20	9,00€

REF.	mm				€
12066	17	0.20	10	100	9,00€
12068	19	0.21	10	50	9,50€
12069	21	0.25	10	50	9,50€
12070	22	0.27	10	100	10,50€
12071	24	0.30	10	50	11,00€

53744

63,00€

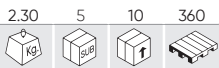

11 PIECE 12-POINT LONG IMPACT SOCKETS SET 1/2"

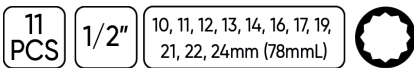

SPARE PARTS AVAILABLE

REF.	mm				€
14738	10	0.15	10	100	5,50€
14739	11	0.15	10	100	5,50€
14740	12	0.16	10	100	5,55€
14741	13	0.15	10	100	5,55€
14742	14	0.15	10	100	5,55€
14743	16	0.14	10	100	5,15€

REF.	mm				€
14744	17	0.18	10	50	5,35€
14745	19	0.22	10	50	6,25€
14746	21	0.24	10	50	6,40€
14747	22	0.27	10	50	7,10€
14748	24	0.30	10	50	8,30€

52810

9,00€

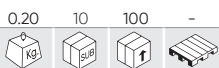

BIT SOCKET XZN TAMPERPROOF M16

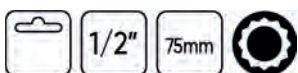

- Impact sockets 75mm long, squared 1/2" to extract the drain screw with impact wrench in transmissions of VAG, Porsche, Ford, etc.

52811

9,90€

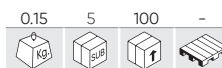

BIT SOCKET XZN TAMPERPROOF M18

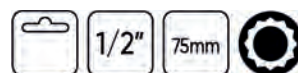

- To extract the vehicle steering arm of VAG vehicles.

52546

39,60€

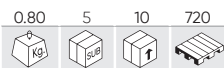

6 PIECE 1/2" XZN IMPACT SOCKET + BITS SET



SPARE PARTS AVAILABLE

REF.	43mmL	kg	SUB	mm	€	REF.	78mmL	kg	SUB	mm	€
12931	M14	0.08	10	200	7,50€	12934	M14	0.13	10	200	7,50€
12932	M16	0.08	10	200	7,50€	12935	M16	0.14	10	200	8,00€
12933	M18	0.09	10	200	8,00€	12936	M18	0.16	10	200	8,50€

52344

197,00€

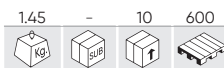

13 PCS. SET OF 1/2" IMPACT BITS HEXAGONAL AND TORX

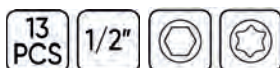

IT CONTAINS

	x5	5, 6, 8, 10, 12mm
	x8	T30, T40, T45, T50, T55, T60, T70, T80

52339

61,00€



8 PIECE SET OF 1/2" HEXAGONAL IMPACT SOCKET BITS



SPARE PARTS AVAILABLE

REF.	mm	kg	SUB	mm	€	REF.	mm	kg	SUB	mm	€
14004	5	0.30	10	240	9,50€	14008	10	0.11	10	240	9,50€
14005	6	0.09	10	120	10,50€	14009	12	0.12	10	240	9,50€
14006	7	0.09	10	240	9,50€	14010	14	0.14	10	120	11,00€
14007	8	0.10	10	240	9,50€	14011	17	0.18	10	60	11,00€

52340

58,00€



8 PIECE SET OF 1/2" TORX IMPACT SOCKET BITS



SPARE PARTS AVAILABLE

REF.	mm	kg	SUB	mm	€	REF.	mm	kg	SUB	mm	€
12938	T25	0.08	10	50	10,00€	12942	T50	0.10	10	60	10,00€
12939	T30	0.10	10	50	10,00€	12943	T55	0.10	10	50	10,00€
12940	T40	0.10	10	50	10,00€	12944	T60	0.12	10	50	10,00€
12941	T45	0.09	10	50	10,00€	12945	T70	0.15	10	50	10,50€

53470

176,00€

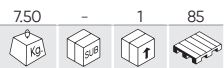

8 PIECE SET OF 3/4" DEEP IMPACT SOCKETS

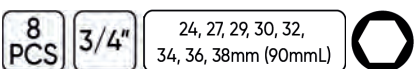

52347

158,00€

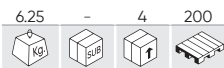

8 PIECE SET OF 3/4" IMPACT SOCKETS

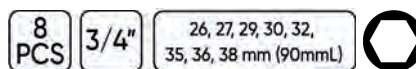

51028

163,00€

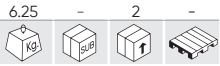

16 PIECES BITS SOCKET

16 PCS 3/4"

SPARE PARTS AVAILABLE

REF.	mm	kg	box	unit	€
14723	H17	0.35	-	10	18,00€
14724	T60	0.30	-	10	18,50€
14725	T70	0.30	-	10	18,50€
14726	T80	10.80	-	10	17,50€

	x4	E18, E20, E22, E24
	x5	T60, T70, T80, T90, T100
	x4	H17, H19, H22, H24
	x2	1 - 3/4"
	x1	4mm



54316

182,00€

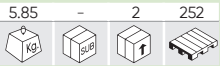

N

8 PIECE SET OF 1" LARGE IMPACT SOCKETS

8 PCS 1"



x6	90mmL	24, 27, 30, 32, 33, 36mm
x2	95mmL	38, 41mm



SPARE PARTS AVAILABLE

REF.	mm	kg	box	unit	€
16304	24	0.60	6	24	31,00€
16305	27	0.70	6	24	31,00€
16571	30	0.77	6	24	32,00€
16572	32	0.95	6	24	33,50€

REF.	mm	kg	box	unit	€
16574	33	0.94	-	-	34,00€
16575	36	1.00	6	24	34,50€
16576	38	1.25	6	24	35,50€
16577	41	1.32	6	24	36,00€

52348

179,00€

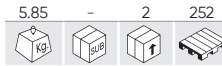

8 PIECE SET OF 1" IMPACT SOCKETS

8 PCS 1"



x2	58mmL	24, 27mm
x3	62mmL	30, 32, 33mm
x2	65mmL	36, 38mm
x1	68mmL	41mm



SPARE PARTS AVAILABLE

REF.	mm	kg	box	unit	€
13859	24	0.50	6	24	16,00€
13874	27	0.60	6	72	17,50€
13875	30	0.50	6	18	18,50€
13876	32	0.60	6	24	18,50€

REF.	mm	kg	box	unit	€
13877	33	0.60	6	96	18,50€
11153	36	0.70	6	18	23,40€
11155	38	0.90	6	12	24,40€
11158	41	0.95	6	18	28,50€

52969

20,70€



3 PIECE HEX. LONG IMPACT SOCKETS

3 PCS 1/2"

17, 19, 21mm (78mmL)

SPARE PARTS AVAILABLE

REF.	mm	kg	box	unit	€
12066	17	0.20	10	100	9,00€
12068	19	0.21	10	50	9,50€
12069	21	0.25	10	50	9,50€



53587

44,00€

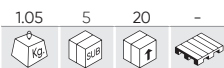

4 PIECES 1/2" DRIVE ALLOY WHEEL IMPACT SOCKET SET



SPARE PARTS AVAILABLE

REF.	mm	kg	5	20	€
14172	15mm	0.20	10	50	8,50€
14173	17mm	0.20	10	50	9,50€
14177	22mm	0.25	10	50	9,50€
14178	21mm	0.25	10	50	9,50€

52338

41,00€

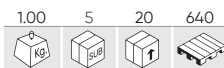

4 PIECE SET OF 1/2" DRIVE ALLOY WHEEL SET



SPARE PARTS AVAILABLE

REF.	mm	kg	5	20	€
11314	17	0.22	10	100	8,50€
11315	19	0.25	10	100	8,50€
11316	21	0.26	10	100	8,50€
11628	22	0.27	10	50	9,50€



51336

29,30€

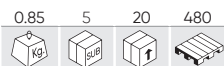

3 PIECES DRIVE ALLOY WHEEL IMPACT SOCKET SET



SPARE PARTS AVAILABLE

REF.	mm	kg	5	20	€
11314	17	0.22	10	100	8,50€
11315	19	0.25	10	100	8,50€
11316	21	0.26	10	100	8,50€

52343

52,00€



12 PIECE 1/2" HEX. IMPACT SOCKET & WHEEL NUT REMOVER SET

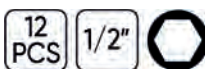

IT CONTAINS

Hexagon	x3	17, 19, 21mm
	85mmL	
Hexagon	x1	27mm
	42mmL	
Hexagon	x8	10, 11, 13, 14, 17, 19, 22, 24mm
	38mmL	

53988

101,00€



10 PIECE 1/2" IMPACT WHEEL SOCKET SET



IT CONTAINS

A	1/2"	15mm	F	1/2"	23mm
B	1/2"	17mm	G	1/2"	24mm
C	1/2"	19mm	H	7/8"	TESLA
D	1/2"	21mm	I	17mm	MERCEDES
E	1/2"	22mm	J	21mm	HYUNDAI / KIA



53197

46,00€

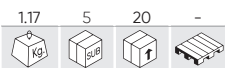

4 PCS ANTI-TWISTING WHEEL LUG IMPACT SOCKET SET



IT CONTAINS

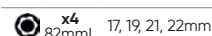

53077

62,00€



DRIVE TORQUE LIMITING EXTENSION BAR SET

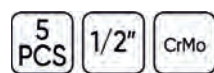

SPARE PARTS AVAILABLE

	REF.	Nm						€
A	13688	100	0.22	-	-	1500	15,50€	
B	13687	110	0.22	5	50	-	15,50€	
C	13686	120	0.23	5	50	1000	15,50€	
D	13685	135	0.25	5	50	1500	15,50€	
E	13684	150	0.28	-	50	-	15,50€	



YOU MAY ALSO LIKE...

	REF.	Nm						€
F	13680	200	0.36	50	50	-	15,50€	
G	13681	190	0.35	-	50	-	15,50€	
H	13682	175	0.32	-	50	-	15,50€	
I	13683	160	0.30	-	50	-	15,50€	
J	13689	90	0.20	5	50	1500	15,50€	



DRIVE IMPACT EXTENSION BAR

REF.	mm	"						€
12937	50	1/2"	0.11	10	100	1500	9,50€	
12074	125	1/2"	0.23	10	60	-	11,50€	
12075	250	1/2"	0.45	10	50	-	15,50€	

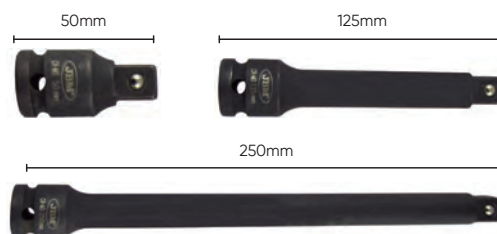

UNIVERSAL JOINT IMPACT SOCKET

REF.	"						€
11938	3/4"	0.62	10	50	-	47,00€	
11990	1/2"	0.15	10	100	-	15,30€	



53043

53,00€

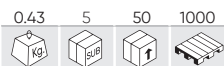

3-PCS UNIVERSAL JOINT IMPACT SOCKET WITH DOUBLE POSITION (FIXED/ARTICULATED)



53044

121,00€



8-PCS IMPACT SOCKET WITH DOUBLE POSITION (FIXED/ARTICULATED)

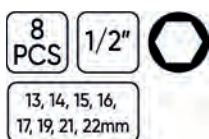

13, 14, 15, 16,
17, 19, 21, 22mm



52545

177,00€

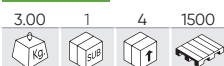

2PCS 1" 1/2" IMPACT ADAPTERS

1" 1/2" F - 1" M
1" F - 1" 1/2" M



53743

39,70€



6 PIECES IMPACT SOCKET ADAPTOR SET



SPARE PARTS AVAILABLE

REF.	mm				€
14749	1/4"H - 3/8"M	0.03	20	200	2,00€
14750	3/8"H - 1/4"M	0.05	20	100	2,00€
14751	3/8"H - 1/2"M	0.15	20	100	4,00€
14752	1/2"H - 3/8"M	0.16	10	100	4,00€
11962	1/2"H - 3/4"M	0.17	10	100	7,50€
11964	3/4"H - 1/2"M	0.35	10	100	12,50€

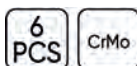

52544

93,00€



6 PCS IMPACT ADAPTERS



SPARE PARTS AVAILABLE

REF.	mm				€
11962	1/2"H - 3/4"M	0.17	10	100	7,50€
11963	1/2"H - 1"M	0.25	6	54	9,00€
11964	3/4"H - 1/2"M	0.35	10	100	12,50€
11965	3/4"H - 1"M	0.45	6	48	16,00€
11966	1"H - 1/2"M	0.54	6	36	18,00€
11967	1"H - 3/4"M	0.56	4	36	18,00€



IMPACT SOCKETS



1"

REF.	mm				€
11153	36	0.70	6	18	23,40€
11154	37	0.73	6	24	21,70€
11155	38	0.90	6	12	24,40€
11156	39	0.74	6	24	28,90€
11157	40	0.78	6	12	26,60€
11158	41	0.95	6	18	28,50€
11159	42	1.00	6	18	30,30€
11160	43	0.95	6	12	27,00€
11161	44	0.90	6	18	32,30€
11162	45	1.10	4	8	29,10€
11163	46	1.00	4	12	32,70€
11164	47	1.05	4	8	30,70€
11165	48	1.00	4	8	34,60€
11166	50	1.21	4	12	30,90€
11167	51	1.18	4	8	38,00€
11168	52	1.18	1	10	41,00€
11169	53	1.27	4	12	39,20€
11170	54	1.33	4	12	40,00€
11171	55	1.44	2	8	51,00€
11172	56	1.47	4	8	48,00€
11173	57	1.44	4	8	47,00€
11174	58	1.58	4	8	47,00€
11175	59	1.58	4	120	49,00€
11176	60	1.75	2	4	56,00€
11177	62	1.63	2	4	55,00€
11178	63	1.75	-	8	53,00€
11179	65	1.87	2	8	65,00€
11180	67	1.93	2	8	59,00€
11181	68	1.93	2	8	65,00€
11182	70	2.05	2	4	73,00€
11183	71	3.10	-	6	70,00€
11184	73	3.27	-	4	87,00€
11185	75	3.34	-	6	97,00€
11186	76	3.35	-	5	91,00€
11187	78	3.47	-	5	98,00€
11188	80	3.60	-	4	103,00€
11189	85	3.80	-	4	121,00€
11190	89	3.80	-	2	138,00€
11191	90	3.90	1	4	149,00€
11192	92	4.85	-	2	152,00€
11193	95	4.90	-	2	183,00€
11194	100	4.43	1	4	176,00€
11621	105	8.50	-	2	290,00€
11622	110	8.13	1	2	399,00€
11623	115	8.62	-	2	489,00€

1" (90mmL)

EXTRALARGE

REF.	mm				€
13745	28	0.77	6	24	25,20€
13746	30	0.95	6	12	25,40€
13747	32	0.92	6	12	25,40€
13748	33	0.88	6	12	24,90€

1/2"

REF.	mm				€
14728	10	0.10	5	20	3,80€
14729	11	0.05	10	100	3,80€
14730	12	0.05	10	100	3,80€
14731	13	0.10	5	20	3,80€
14732	14	0.10	5	20	3,80€
11195	17	0.10	10	100	3,70€
11121	19	0.10	10	60	4,10€
14733	21	0.10	5	20	4,30€
14734	22	0.15	5	20	5,40€
11122	24	0.14	10	20	5,45€
11123	27	0.20	10	50	6,50€
11124	30	0.20	10	50	7,65€
11125	32	0.23	10	50	8,50€

1/2" (78mmL)

LARGE

REF.	mm				€
12061	10	0.14	10	100	9,50€
14736	11	0.15	5	20	5,00€
12062	12	0.15	10	100	9,50€
12063	13	0.15	10	50	9,50€
14737	14	0.15	5	20	5,00€
12064	15	0.17	10	100	9,00€
12065	16	0.30	10	20	9,00€
12066	17	0.20	10	100	9,00€
12067	18	0.22	10	20	9,50€
12068	19	0.21	10	50	9,50€
12069	21	0.25	10	50	9,50€
12070	22	0.27	10	100	10,50€
12071	24	0.30	10	50	11,00€
12072	27	0.36	10	20	12,00€

3/4"

REF.	mm				€
11126	19	0.25	-	10	11,20€
11127	21	0.30	6	24	13,80€
11128	22	0.35	6	24	14,10€
11129	24	0.32	6	54	14,10€
11130	25	0.45	6	24	13,10€
11131	26	0.32	6	36	14,10€
11132	27	0.30	6	54	13,70€
11133	28	0.40	6	12	12,00€
11134	30	0.41	6	24	15,00€
11135	32	0.45	6	48	17,20€
11136	33	0.50	6	12	15,30€
11137	34	0.50	6	24	18,20€
11138	35	0.50	6	12	18,00€
11139	36	0.50	6	24	18,80€
11140	38	0.55	6	24	20,40€
11141	40	0.55	6	12	18,60€
11142	41	0.60	6	12	21,30€
11143	46	0.75	6	18	26,40€
11144	50	1.00	6	24	33,30€
11145	51	1.10	4	12	35,30€
11146	55	1.23	4	12	37,30€
11147	57	1.25	4	12	41,00€
11148	60	1.40	4	12	47,00€
11149	63	1.32	4	12	45,00€
11150	65	1.35	-	8	55,00€
11151	67	1.49	4	12	57,00€
11152	70	1.49	4	12	57,00€

3/4" (90mmL)

LARGE

REF.	mm				€
13723	19	0.43	6	12	18,50€
13724	21	0.50	6	12	19,20€
13725	22	0.61	6	18	19,20€
13726	24	0.56	6	24	19,00€
13727	26	0.51	6	18	18,70€
13728	27	0.50	6	18	18,50€
13729	29	0.70	6	12	22,00€
13730	30	0.70	6	24	22,00€
13731	32	0.71	6	24	21,60€
13732	33	0.75	6	24	23,80€
13733	34	0.85	6	18	24,90€
13734	35	0.80	6	18	25,70€
13735	36	0.81	6	12	25,80€
13736	38	0.83	6	18	25,90€



1"

REF.	mm				€
11624	65	2.40	1	2	189,00€
11625	85	5.35	1	2	282,00€
12984	105	5.00	1	2	379,00€

1/2" (78mmL)

LARGE

REF.	mm				€
14738	10	0.15	10	100	5,50€
14739	11	0.15	10	100	5,50€
14740	12	0.16	10	100	5,55€
14741	13	0.15	10	100	5,55€
14742	14	0.15	10	100	5,55€
14743	16	0.14	10	100	5,15€
14744	17	0.18	10	50	5,35€
14745	19	0.22	10	50	6,25€
14746	21	0.24	10	50	6,40€
14747	22	0.27	10	50	7,10€
14748	24	0.30	10	50	8,30€
11613	27	0.35	10	20	11,00€
11614	30	0.40	6	24	13,00€
11615	32	0.45	6	24	14,20€
11616	33	0.44	6	12	18,10€
11617	34	0.42	6	24	18,70€
11618	35	0.48	6	18	18,80€
11619	36	0.47	4	48	19,50€

52914 223,00€



TRUCK HUBCAPS SOCKET
BPW 120MM DR.41MM



120mm
8 FACES
HEXAGONAL SQUARE 41mm

52915 199,00€



TRUCK WHEEL NUT SOCKET
BPW 111MM DR.41MM



111mm
OVAL
HEXAGONAL SQUARE 41mm

52916 218,00€



TRUCK WHEEL NUT SOCKET
BPW 109MM DR.41MM



109mm
8 FACES
HEXAGONAL SQUARE 41mm

52917 122,00€



BPW ROLLER AXLE NUT
SOCKET 65MM



65mm
OVAL
DIAGONAL 36mm

52918 146,00€



REAR SHAFT HUBCAPS
SOCKET BPW 95MM



95mm
3/4" SQUARE

52919 181,00€



WHEEL NUT SOCKET BPW
110MM 3/4"



110mm
8 FACES
3/4" SQUARE

52920 155,00€



BEARING SHAFT EXTRACTION
SOCKET BPW 80MM 3/4"



80mm
3/4" SQUARE

52921 117,00€



REAR SHAFT NUT EXTRACTION
SOCKET BPW 65MM 3/4"



65mm
3/4" SQUARE

52922 180,00€



BEARING SHAFT EXTRACTION
SOCKET BPW 85MM 3/4"



85mm
6 FACES
3/4" SQUARE

52923 59,00€



SUSPENSION SCANIA NUT
EXTRACTION SOCKET
28X37MM 3/4"



28x37mm
3/4" SQUARE

52924 52,00€



SUSPENSION SCANIA SHAFT
EXTRACTION SOCKET
34X46MM 3/4"



34x46mm
3/4" SQUARE

52925 176,00€

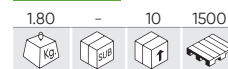

SCANIA FRONT WHEEL
SOCKET 80MM H41



80mm
8 FACES
HEXAGONAL SQUARE 41mm

52926 201,00€



SCANIA REAR WHEEL SOCKET
100MM 3/4" 8 EDGES



100mm
8 FACES
3/4" SQUARE

52927 59,00€



REAR SCANIA SHOCK
ABSORBER SOCKET 34X56MM
3/4"



34x56mm
3/4" SQUARE

52928 172,00€



SCANIA FRONT WHEEL
SOCKET 80MM 3/4" 8 EDGES



80mm
8 FACES
3/4" SQUARE

52929 185,00€



SCANIA WHEEL NUT SOCKET
95MM 3/4" 8 EDGES



95mm
8 FACES
3/4" SQUARE

IMPACT TOOLS

52930 117,00€



SCANIA TRUCK INSTALLATION
REAR CRANKSHAFT OIL SEAL
TOOL



SCANIA 310/320
OIL SEAL 0366303-R

52931 45,00€

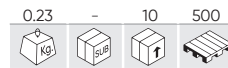

SCANIA TRUCK CAMSHAFT
ROTATION SOCKET 1/2"



1/2" SQUARE

52932 45,00€

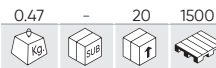

SOCKET FOR
ELECTROMAGNETIC
INJECTION VALVE SCANIA
38MM 1/2 "



Ø38mm
1/2" SQUARE

52933 194,00€

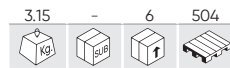

SCANIA 8 BATTLEMENTS
SOCKET 420



Ø11,6mm - Ø10mm
8 MERLONS
3/4" SQUARE
SCANIA 420

53430 286,00€



IVECO AXLE NUT SOCKET



Ø134mm - Ø110,5mm
118x134mm
IVECO
12 FACES

52935 94,00€



PRISONER TRUCK NUT
SOCKET BENZ/MAN 60MM



60mm
3/4" SQUARE

52936 199,00€

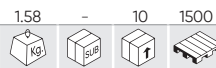

TRUCK REAR SHAFT SOCKET
BENZ/MAN 80-95MM



80-95mm
3/4" SQUARE
6 MERLONS

52937 265,00€

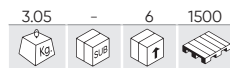

TRUCK REAR SHAFT NUT
EXTRACTION SOCKET BENZ/
MAN 95-115MM



95-115mm
3/4" SQUARE
6 MERLONS

52938 199,00€



TRUCK DIRECTION NUT
EXTRACTION SOCKET BENZ/
MAN H60 3/4"



100mm
3/4" SQUARE
6 MERLONS

52939 28,00€



TRUCK SOCKET BENZ/MAN
FOR EXTRACTION DIESEL
VALVE INJECTION



22-28mm
1/2" SQUARE
4 MERLONS

52940 235,00€



TRUCK SOCKET BENZ/MAN
FOR NUT REAR DIFFERENTIAL



101mm
3/4" SQUARE
6 MERLONS

52941 70,00€



WHEEL ROTATION MOTOR
AND GEARS TOOL BENZ/
MAN 2



1/2" SQUARE

52942 105,00€

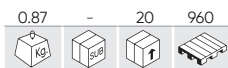

WHEEL ROTATION MOTOR
AND GEARS TOOL BENZ/MAN
3 GEAR



1/2" SQUARE

52943 75,00€



TRUCK WHEEL ROTATION
TOOL FOR MOTOR MAN



1/2" SQUARE

52934 102,00€

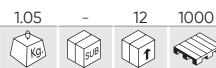

PRISONER TRUCK NUT
SOCKET BENZ/MAN 56MM



56mm
3/4" SQUARE

REF.	mm			€
52944	30	1.00	20	110,00€
52945	39	2.74	24	281,00€

BALL JOINT-PULLER BELL
VIBRO-IMPACT



52944
HEXAGONAL
SQUARE
19mm

52945
HEXAGONAL
SQUARE
26mm

CAR BODY WORK

- 180 SHEET METAL WORK TOOLS
- 183 HEADLIGHT RESTORATION
- 185 GLASS REPLACEMENT
- 186 CHASSIS REPAIR
- 188 AUXILIARY FURNITURE
- 191 INTERIOR MAINTENANCE



CAR BODY WORK

53224

142,00€

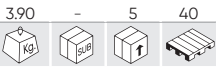

DENT TOOL KIT

32 PCS AUDI

SPARE PARTS AVAILABLE

REF.	DESCRIPTION					€
13842	BAG OF 5 PCS BLUE PAD (REF.53224)	0.15	10	100	-	8,50€
13843	BAG OF 4 PCS YELLOW PAD (REF.53224)	0.01	10	100	-	7,00€
13844	BAG OF 10 PCS RED PAD (REF.53224)	0.05	10	50	-	9,00€
13845	BAG OF 5 GLUE BAR (REF.53224)	0.02	10	100	-	8,00€



52876

182,00€

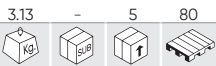

7 PIECE RUBBERISED DOLLY SET

SPARE PARTS AVAILABLE

REF.	DESCRIPTION					€
A	12955 FLAT FACE & OVAL FACE TAS	0.28	-	25	99	27,80€
B	12956 RAIL TAS	0.31	-	25	99	27,80€
C	12957 OVAL FACE TAS	0.37	5	25	99	27,80€
D	12958 HANDLE WITH WEDGE TAS	0.41	-	25	-	27,80€
E	12959 TAS IN COMMA	0.30	5	25	99	27,80€
F	12960 TAS HEELED	0.18	-	25	1500	27,80€
G	12961 TAS IN COMMA WITH WEDGE	0.34	-	25	-	27,80€



51131

61,00€

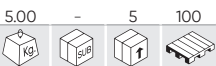

7PC PANEL BEATING SET

SPARE PARTS AVAILABLE

REF.	DESCRIPTION					€
A	11541 BUMPING HAMMER	0.43	5	25	-	11,00€
B	11542 REVERSE CURVE HAMMER	0.38	5	25	-	11,00€
C	11543 PICK AND FINISH HAMMER	0.42	5	25	-	11,00€
D	11544 UTILITY DOLLY	0.69	5	25	-	7,00€
E	11545 SHRINKING DOLLY	0.79	5	25	-	11,00€
F	11546 DOUBLE END DOLLY	0.81	5	25	-	12,00€
G	11547 CURVE DOLLY	0.81	5	25	-	12,00€



53545

35,70€

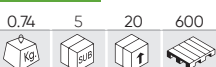

5 PIECE 3/8" HEXAGONAL SOCKETS - EXTRA LONG

5 PCS 3/8" CrV
 BMW, FORD, OPEL, VAG, VAUXHALL



8, 10, 12, 13, 14mm (120mmL)

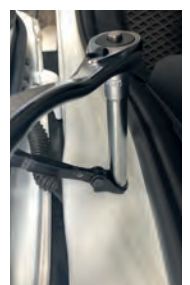

51832 18,00€

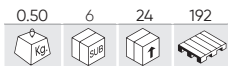

4 NYLON LEVERS SET

4 PCS
 19mm x 273mm
 22mm x 273mm
 25mm x 273mm
 38mm x 273mm



50903 30,80€

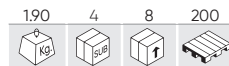

SET OF 5 METAL LEVERS WITH HANDLE

5 PCS
 60, 43, 38,
 28, 18cm



52026 31,80€

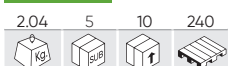

SET OF 2 METAL LARGE LEVERS WITH HANDLE

2 PCS 90cm

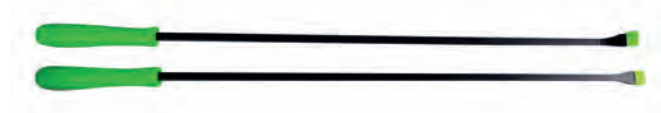

51360 8,05€



WRECKING BAR 18"X5/8

18" x 5/8



51361 9,80€



WRECKING BAR 24" X 3/4

24" x 3/4

52851 9,65€



SET OF 2 LEVERS

2 PCS 200mm 225mm

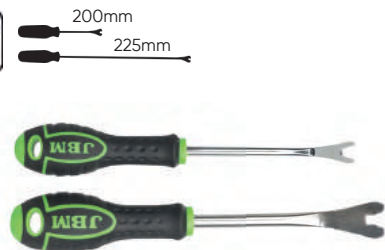

53110 27,30€



6 LEVER SET

6 PCS
 5"x8.5mm
 5"x10.3mm
 5"x4.5mm
 15"x8.5mm
 15"x10.3mm
 15"x4.5mm

240mm 490mm



50901 16,00€

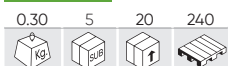

SET 5 NYLON LEVERS

5 PCS

UNIVERSAL
 60x160mm
 63x175mm
 30x200mm
 20x180mm
 20x215mm



52788 39,00€



27 NYLON LEVER SET

27 PCS



CAR BODY WORK

52977

137,00€

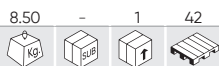

4PCS PRY BAR SET EXTRALONG



52540

221,00€



PNEUMATIC SUCTION CUP DENT PULLER

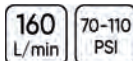

54017

12,00€



SILICONE CAULKING TOOL



IT INCLUDES 5 REPLACEABLE SILICONE PADS: 3R, 6R, 10R, 13R, 17R



52533

10,00€



SILICONE CAULKING GUN 300ML

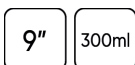

53525

12,00€



LOCKING CLAMP FOR HOOD AND TRUNK OPENERS



- Maximum opening diameter: 10mm.

53655

12,00€



DOOR HANDLE REMOVING TOOL VAG



54246

104,00€



5KG PRECISION SCALE



54247

99,00€



2KG PRECISION SCALE

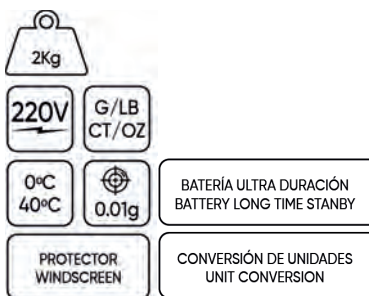

53230

19,70€

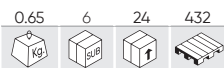

LOCK-OUT TOOL SET



52077

29,50€



4 PCS INFLATABLE PAD SET

40-50mm

IT CONTAINS
16 x 16cm Pad
32 x 12cm Pad
19 x 6cm Pad
18 x 4.5cm Pad
Manual pump

- Max. pressure supported: 100kg.



53486

29,30€



DENT MIRROR

Ø 800mm

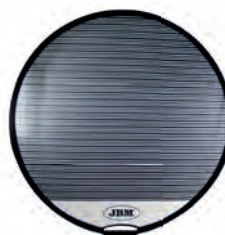

53673

80,00€

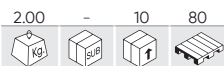

HEADLIGHT RESTORATION SET

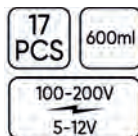

15375

28,00€

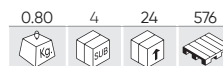

600ML BOTTLE WITH LIQUID FOR 53673

The liquid polymer headlamp refurbishment kit is an innovative system for restoring sunburnt headlamps to their original condition, with the original gloss and a perfect finish.



UFI: 9600-WOPH-M003-4PRX

ORIGINAL GLOSS AND A PERFECT FINISH

SPARE PARTS AVAILABLE

REF.	DESCRIPTION	kg	SUB	QTY	€
A	14564 6 PCS ABRASIVE PAPER SET FOR 53673	0.10	10	100	9,20€
B	14565 AC-DC ADAPTER FOR 53673	0.20	10	50	26,70€
C	14566 12V ADAPTER FOR 53673	0.05	10	100	16,70€
D	14567 EVAPORATING CUP FOR 53673	0.15	10	20	38,00€
E	14568 CURVED CAP WITH RUBBER SEAL RING FOR 53673	0.01	10	200	9,20€
F	14569 FLAT CAP WITH ONE RUBBER SEAL RING FOR 53673	0.00	10	200	9,20€
G	14570 FUNNEL FOR 53673	0.01	10	200	4,05€
H	14571 GRINDING PLATE FOR 53673	0.05	-	10	9,20€
I	14573 TEXTURED PAPER FOR 53673	0.01	10	100	4,05€
J	15375 600ML BOTTLE WITH LIQUID FOR 53673	0.80	4	24	28,00€

BAG OF 10 ABRASIVE PAPER

REF.	DESCRIPTION	kg	SUB	QTY	€	REF.	DESCRIPTION	kg	SUB	QTY	€
14710	GRAIN 180	0.25	10	100	3,50€	14713	GRAIN 600	0.15	10	100	4,25€
14711	GRAIN 280	0.20	10	100	3,75€	14714	GRAIN 800	0.15	10	100	4,50€
14712	GRAIN 360	0.20	10	100	4,00€	14715	GRAIN 1200	0.10	10	100	4,75€



VIDEO TUTORIAL

CAR BODY WORK

52740

690,00€

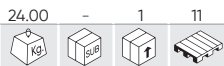

LAMPCHK HEADLIGHT ALIGNER WITH LUXMETER 152CM



HALOGEN / XENON / LED

- Measurement distance: 50 cm.
- Easy optical axis deviation measurement from the dipped headlight and beam headlight.
- Also for trucks

52836

1.100,00€

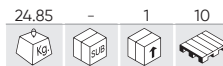

DOUBLE LAMPCHK HEADLIGHT ALIGNER WITH LASER AND LUXMETER



HALOGEN / XENON / LED

- Also for trucks

DOUBLE LASER
DIGITAL LIGHT METER
REGULATION VERIFICATION SCREEN

53626

18,00€



HEADLIGHT RESTORATION SET



IT CONTAINS

- | | |
|----------------------------|----------------------|
| x2 P800 Sanding Discs | x1 85gm Polish Paste |
| x2 P1200 Sanding Discs | x1 Masking tape |
| x2 P2000 Sanding Discs | x1 Wool Polish Disc |
| x2 3.0ml UV Protect Liquid | x1 White Sponge Disc |
| x2 Adapter (3/8" & 1/4") | |

IN 12 UNITS
DISPLAY CASE



SERIE262

199,00€

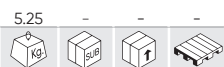

POLISHING KIT: 3" AIR POLISHER + 12 HEADLIGHTS RESTORATION KITS

53626

x12u.



53646

x1u.



53729

19,10€

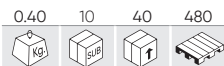

HEADLIGHT ADJUSTMENT TOOL SET

H6, H7, T25



52262

7,50€

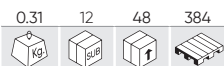

SUCTION PAD Ø 115MM

40Kg
ø 115mm



52263

13,50€

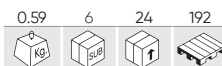

DOUBLE SUCTION PAD Ø 115MM

70Kg
ø 115mm



52264

18,60€

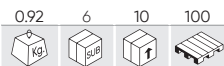

TRIPLE SUCTION PAD Ø 115MM

100Kg
ø 115mm



52265

30,50€

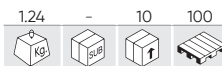

QUADRUPLE SUCTION PAD Ø 115MM

120Kg
ø 115mm



52295

6,50€

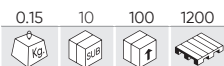

SET OF 2 MINI SUCTION PAD Ø 60MM

5Kg
ø 60mm



52765

21,70€

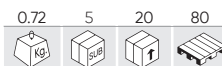

DOUBLE SUCTION PAD ARTICULATED Ø 120MM

80Kg
ø 120mm



52998

48,00€

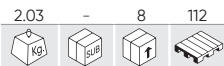

SUCTION LIFTER SET 5M X 25MM

80Kg
ø 120mm
5x25mm



53232

39,00€

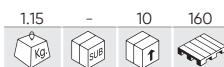

WINDSHIELD REMOVAL TOOL SET

7
PCS



IT CONTAINS
1x Windshield removal tool.
1x Windshield molding release tool.
1x Trim pad remover.
1x 1.8m wire.
2x Wire gripping handle.
1x Wire feeder tool.

13813

7,00€



WIRE FOR WINDSHIELD REMOVAL

FOR REF. 53232



13814

11,00€

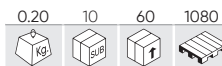

WINDSHIELD REMOVAL HANDLES

FOR REF. 53232



CAR BODY WORK

52321 8,80€



SUBJECTION TAPE WITH TENSIONER 5M X 25MM

5mx25mm



52327 12,00€



SUBJECTION TAPE WITH TENSIONER 8M X 25MM

8mx25mm



50577 12,60€



CURVED JAW LOCKING PLIER

CrV
280mm



52386 23,60€



PARROT NOSE GRIP WRENCH - FLAT

CrMo
215mm



52385



SELF LOCKING MULTI GRIP PLIER SET

251,00€

W (195mm)



JJ (195mm)



LL (195mm)



J (210mm)



T (215mm)



L (225mm)



LOCKING PLIERS

REF.	DESCRIPTION								€
53675	STRAIGHT JAW LOCKING PLIERS	10"	250mm	70mm	0.75	10	20	300	50,00€
53676	CURVE JAW LOCKING PLIERS	10"	250mm	90mm	0.85	10	20	300	44,00€
53677	CURVE JAW LOCKING PLIER WITH SWIVEL PAD	10"	250mm	80mm	0.90	10	20	300	55,00€
53678	LONG-CURVE JAW LOCKING PLIER	10"	300mm	105mm	0.90	10	20	300	52,00€



53675



53676



53677



53678



IN 10 UNITS
DISPLAY CASE

52982







3 PIECES EXTRA-LONG LOCKING PLIERS SET

53,00€



EXTRA-WIDE OPENING LOCKING PLIERS

REF.	DESCRIPTION	mm	MATERIAL		T					€
52390	PLUGWELD PLIER	250mm	CrMo	-	-	0.50	5	40	640	35,20€
52474	RING CLAMP 5T	190mm	Steel	0-20mm	5T	3.49	-	5	1500	68,00€
52475	LONG NOSE CLAMP 3T	170mm	Steel	0-25mm	3T	3.60	-	10	1500	62,00€
52476	HEAVY DUTY CLAMP 5T	220mm	Steel	0-25mm	5T	3.10	-	10	1500	50,00€
52477	GAP HOOKS CLAMP 2T	200mm	Steel	0-60mm	2T	2.65	-	6	1500	70,00€
52478	5T 90° ANGLE PULL CLAMP	170mm	Steel	0-20mm	5T	2.90	-	10	1500	49,00€
52479	90° 3T C CLAMP	155mm	Steel	0-20mm	3T	1.18	-	30	1500	24,70€
52480	3T BOX CLAMP WITH PULL BRACKET	210mm	Steel	0-25mm	3T	2.00	-	10	1500	44,00€
52481	BOX CLAMP 3T	220mm	Steel	0-20mm	3T	2.05	-	10	1500	52,00€
52482	SMALL MOUTH PULL CLAMP TWO-WAY 5T	210mm	Steel	0-10mm	5T	2.13	-	8	1500	44,00€
52483	5T SMALL MOUTH PULL CLAMP SINGLE WAY	210mm	Steel	0-10mm	5T	2.02	-	12	1500	41,00€
52484	3T DOUBLE CLAW HOOK	275mm	Steel	0-110mm	3T	1.19	-	11	1500	66,00€
52485	4T CHAIN JOINT (DOUBLE GRAB HOOK ASSEMBLY)	270mm	Steel	0-90mm	4T	1.17	-	30	1000	51,00€
52486	3T CHAIN JOINT (CLAW HOOK & GRAB HOOK ASSEMBLY)	280mm	Steel	0-110mm	3T	1.21	-	11	1500	62,00€
52487	PULL CLAMP 5T	220mm	Steel	0-20mm	5T	2.27	-	7	1000	63,00€
52502	11" LOCKING C-CLAMP	280mm	CrMo	0-110mm	-	0.84	10	30	540	31,40€
52503	LOCKING C-CLAMP W/PAD	280mm	CrMo	0-105mm	-	0.85	10	30	540	32,50€
52504	9" WELDING CLAMP	225mm	CrMo	0-50mm	-	1.14	-	30	480	27,60€
52505	6" LOCKING C-CLAMP	170mm	CrMo	0-40mm	-	0.27	36	72	2160	20,80€
52506	6" LOCKING C-CLAMP W/PAD	170mm	CrMo	0-50mm	-	0.28	36	72	2160	16,00€
52507	SHEET METAL TOOL	250mm	CrMo	0-80mm	-	0.77	5	30	420	30,10€
52511	18" LOCKING C-CLAMP	440mm	CrMo	0-225mm	-	1.31	-	20	280	42,00€
52512	18" LOCKING C-CLAMP W/PAD	440mm	CrMo	0-210mm	-	1.31	-	20	280	50,00€



53983

215,00€

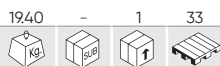

PARTS CARRIER - WINDSHIELD AND HOOD



12PCS 630MM BAR WITH EPE FOAM COVER

EXTENSIVE UP 5 LARGE PANELS OR GLASS

4x4 INCH PU CASTORS (TWO SWIVEL WITH BRAKE)

53125

477,00€

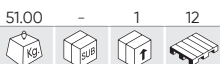

AUTOMOTIVE PARTS CART



53124

287,00€



HEIGHT SIZE



LENGTH SIZE



50923

454,00€



SPECIAL PLATE TRANSPORT CART



- Separation: 0 to 110cm.



REF.	DESCRIPTION	kg	sub	unit	length	width	height	€
12022	SPARE WHEEL FOR 50923	1.94	-	10	1500	33,70€		

53080 99,00€



PORTABLE WINDSHIELD STAND



52749 79,00€

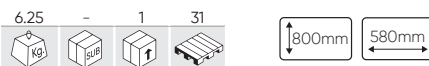

PORTABLE WORKING FOLDING STAND



53079 89,00€

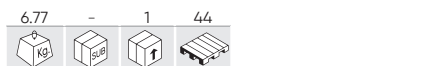

X-TRESTLE



UNFOLDED SIZE

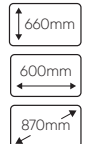

FOLDED SIZE

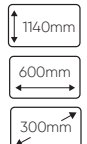

REF.	DESCRIPTION	Kg	Box	Unit	€
11959	ACC. FOAM FOR STAND REF. 52749	0.08	100		10,50€

53736 98,00€



FOLDING BUMPER STAND



ADJUSTABLE STAND WIDTH WITH EXTENDABLE ARMS MAKES THIS UNIT SUITABLE FOR HOLDING VARIOUS TYPES AND STYLES OF BUMPERS

ADJUSTABLE STAND: 75 CM -160CM

MAXIMUM HEIGHT: 148CM

STEEL WITH POWDER COATED

53685 310,00€



ADJUSTABLE BUMPER STAND



ADJUSTMENT OF THE SUPPORT ARMS FROM 134 - 198CM

4x4 INCH CASTORS (TWO SWIVEL CASTORS WITH BRAKES)

POWDER COATED STEEL

53134 144,00€

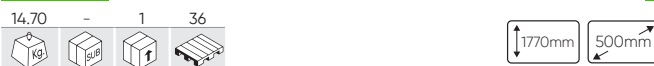

ADJUSTABLE PAINT HANGER

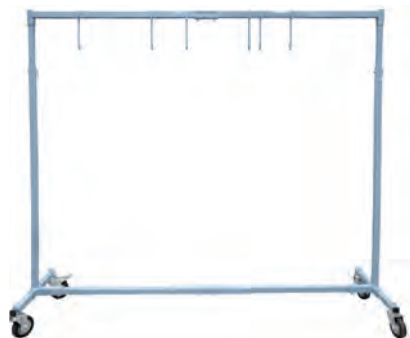

- 6 hooks to hold parts for painting or drying.
- Adjustable frame that extends from 127cm to 203cm.

53126 243,00€



ROTATING PAINT PANEL STAND



6 HOLDING ARMS: 4 WITH FIXED HOOK 2 WITH HOLES



52230

398,00€

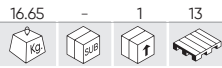

STEP ALUMINIUM WORKING PLATFORM

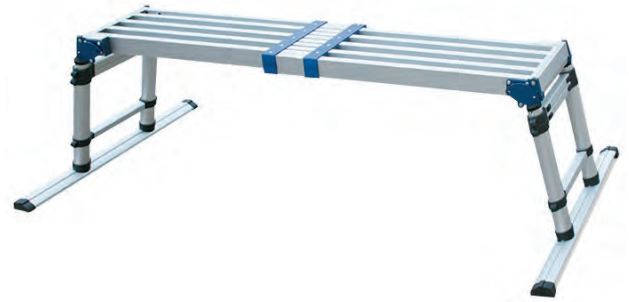
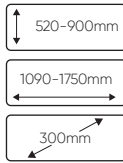

REF. DESCRIPTION

REF.	DESCRIPTION	KG	SUB	QTY	PARTS	€
10964	CORNER RUBBER SPARE PARTS FOR REF. 52230	0.01	-	1	-	9,00€
10965	LADDER SPARE PART FOR REF. 52230	0.01	-	1	-	6,00€
10966	RUBBER STOPPED SPARE PARTS FOR REF. 52230	0.06	-	1	-	13,50€

CERTIFICATION: EN 131

50913

195,00€

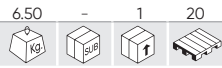

LARGE STEP ALUMINIUM WORKING PLATFORM



CERTIFICATION: EN 131

50656

290,00€

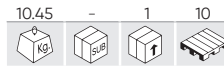

2 PIECES STEP ALUMINIUM WORKING PLATFORM SET



CERTIFICATION: EN 131

REF. DESCRIPTION

REF.	DESCRIPTION	KG	SUB	QTY	PARTS	€
11897	100x30x30cm	4.66	-	1	16	155,00€
15552	130x30x55cm	6.80	-	1	18	181,00€

53922

29,00€

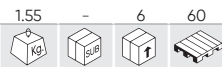

WALL PAPER ROLL DISPENSER

- Stainless steel
- Roll: Maximum width of 38 cm.
- Grey ABS plastic saw.
- Mounted with stainless steel screw and nuts.

PAPER NOT INCLUDED

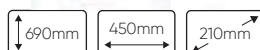
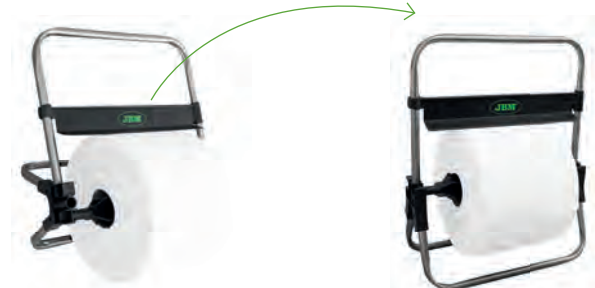

53921

39,00€

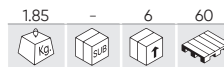

FLOOR STAND ROLL DISPENSER

- Material: Stainless steel.
- Roll: Max. width 38 cm.
- ABS plastic saw.

PAPER NOT INCLUDED

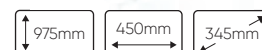

DISPLAY + VEHICLE CARE MATERIAL SET

50400 168,00€

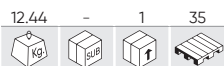

IT INCLUDES

- 53705 DISPLAY
- 51978 SEAT COVER ROLL
- 52057 STEERING WHEEL COVER FILM ROLL
- 52058 HANDLE FOR STEERING WHEEL
- 50409 ANONYMOUS PAPER FOOTREST COVER

50403 98,00€

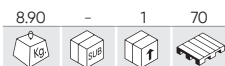

IT INCLUDES

- 52065 DISPLAY
- 51978 SEAT COVER ROLL
- 52057 STEERING WHEEL COVER FILM ROLL
- 52058 HANDLE FOR STEERING WHEEL

50410 168,00€



IT INCLUDES

- 53705 DISPLAY
- 52244 SEAT COVER ROLL
- 52057 STEERING WHEEL COVER FILM ROLL
- 52058 HANDLE FOR STEERING WHEEL
- 50409 ANONYMOUS PAPER FOOTREST COVER

SEAT COVER SPOOL + STERRING WHEEL ROLL + FOOT COVER DISPLAY

53705 80,00€

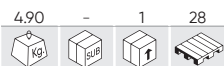

51985 84,00€

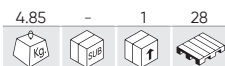

52065 45,00€



51978 84,00€



SEAT COVER ROLL 25MC 250U.



52244 84,00€



SEAT COVER ROLLS WHITE MODEL 250 UNITS 25MC



52057 6,80€



STEERING WHEEL COVER FILM ROLL

23 mc - Length: 200m
- Width: 12,5cm
- Thickness: 23mc

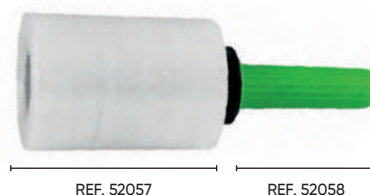

REF. 52057

52058 4,50€



HANDLE FOR STEERING WHEEL COVER FILM ROLL FOR REF. 52057

23 mc

REF. 52058

CAR BODY WORK

50409

26,00€

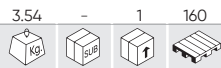

ANONYMOUS PAPER FOOTREST COVER

250
PCS



51824

36,80€

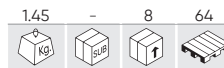

PACK OF 250 STEERING WHEEL COVERS

250
PCS



50916

0.05 100 400 3200



INDIVIDUAL BAG MAINTENANCE KIT

5
PCS

20
mc



0,88€



53226

14,90€

0.20 5 50 600



CAR SEAT COVER



- NYLON
- UNIVERSAL.

51622

25,30€

0.45 - 30 780



MAGNETIC PROTECTOR COVER FINS AND FRONTS



4 MAGNETIZED POINTS

TWO FACES:
ONE VELVET / ONE PLASTIC



TELESCOPIC EXTENSION POLE

REF.	Max.	Min.					€
52497	1200mm	530mm	0.29	6	48	480	26,80€
53196	1600mm	710mm	0.37	6	48	384	33,00€



BRAKES

194 RETRACTOR TOOLS

197 BRAKE BLEEDER

197 MAINTENANCE



52636

114,00€

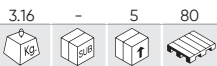

16 PCS

SET BRAKE PISTONS REWINDING TOOL WITH PNEUMATIC TOOL

- 0 General Motors (Ø pistons 2-1/2")
- 2 Citroën XM/Xantia (F/R), HONDA
Audi (F), Fiat, Alfa romeo (F), Ford Fiesta (F), Isuzu (F), Honda Concesto (F), Jaguar XJ6/ XJ40 (F/R), BMW 318is / 320i / 325T / 518i / 525i-1x / 740i / 850ci / M5 (F), Mercedes BENZ 190/200/300/420/560 serie (F), Mitsubishi Colt (F), Nissan Miera/Stanza/Sunny (F), Rover Austin/Metro200-400 series/Maestra/Montego (F), Toyota Camry (F), Volvo (F), VW Passat/Golf GTI (F)
- 4 Ford Australia/NZ Telstar, Mazda (R), Saab 9000 (R)/Lumina, Toyota, Fiat 164 2.0 (R), Alfa Romeo Prelude/CRS 16i, Honda Saturn (R)/Grand Prix, GM
- 5 3/8" Antriebs-Adapter
- 6 Nissan Primera, VW Golf IV
Audi 80/90/V8+100/Coupe E (R), Rover 800 ABS, Subaru L+Z (R), Ford Sierra ABS/Granada/Scorpio ABS (R), Nissan Bluebird 1.8 Turbo/Silvia Turbo/Primera2.0i LS-GS-GSX (R), Peugeot 405 1.9Gi/Gri/Sri/Gtxi/MI 16/605 2.0 Sri (R), Toyota Cecilia/Corolla GT/MR2 (R), VW Golf Gti/Jeta Synchron/Jetta Gti 16v, Passat CL, GL, GT, GT 16v, Corrado 16V scirocca GTX 16V(R), Citroën, Alfa romeo, Fiat, Honda, Jaguar, Renault, Saab, Seat, Lancia.
- 7
- 8 General Motors (Ø pistons 1-7/8")
- 9 General Motors (Ø pistons 2-1/8")
- A(Z) Renault (R21-Laguna (R))
- E Nissan Maximas/Cefiro
- F(G) Opel (Rear disk)/ Fiat Stilo
- K Citroën C5
- K1 Renault, Citroën C5

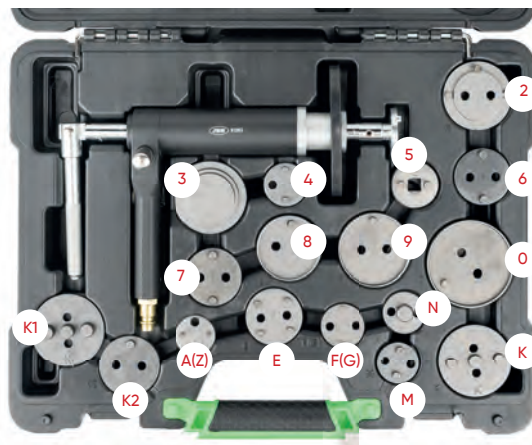

- K2 Renault, Citroën, Audi A8, S8
- M Ford, Mini Cooper, Nissan Primera 03
Saab, Honda, Alfa Romeo 164 2.0 Twin Spark/2.0 Turbo (88-)/3.0 V6, Audi 200 (80-)/Coupe GT SE (82-)/80/90/1Q0/200/Quattro (87-)/90/20V (88-), Ford Mondeo 2.0/Ghia, Lancia Themaalte (85-), Volkswagen Golf II GTI (83-87)/Sirocco 16V (84)
- N

52330

99,00€



50 PCS OPEL PEUGEOT CITRÖEN RENAULT

BRAKE PISTONS REWINDING TOOL SET

- 0 General Motors (Ø pistons 2-1/2")
- 1 Disc
- 2 Citroën XM, Xantia u.a.
- 3 Alfa Romeo,Audi, Austin, BMW, Ford, Honda, Jaguar, Mercedes-Benz. Mitsubishi, Nissan Rover, Toyota, VW
- 4 Alfa Romeo 164 2.0.Ford, Mazda, Saab 9000, Subaru
- 5 3/8" Antriebs-Adapter
- 6 Nissan Primera, VW-Golf IV
Audi 8.0,90,V8 +100, Ford Sierra ABS+ Scorpio ab 85, Honda Prelude, Nissan Silvia 1.8 turbo, Rover 8000, Saab 9000, Subaru L+Z, VW-Golf+ Passat
- 7
- 8 General Motors (Ø pistons 1-7/8")
- 9 General Motors (Ø pistons 2-1/8")
- 11 Disc for Jaguar S type.
- 12 Disc for BMW mini
- A Nissan Premira 2.0, Bluebird
- A1 Ford Transit 06,Transit Connect 02,Tourneo Connect 02,Mondeo 00-07,C-Max 03, Focus 04
- B Ford, Lincoln, Subaru
- B1 Ford S-max 06,Scorpio 94-06,Mondeo 07,Kuga 08,Galaxy 00-06,Focus RS 03,Fiesta 01-02,Cougar 98-01
- C Nissan Primera (02), Opel Vectra 02-,Toyota Avensis
- D Citroën, Renault
- E Cefiro, Maxima
- F Peugeot 206 CC / Hdi / Gti. Requires a 16mm wrench with rear pistons
- F1 Fiat Ducato
- G Opel
- G1 Volkswagon Golf V / VI
Alfa Romeo 155 1.8-2.0 164 TD(93) 164 3.0 V6(91), Audi 80,90,A3,A4,A6,A8, Citroen ZX 2 Ql 16V, Fiat Tipo TD 16V, Uno Turbo (85) Crama TD, Ford Sierra (ABS bak), Granada (85) Crama TD, Ford Sierra (ABS bak), (Australia& NZ) Thunderbird Turbo, Honda CRX, 1.6i-16V (8-90), Accord 1800 (84-85) 2.0i, Prelude 16V (88), Legend V6, Jaguar XJ 4, Oseries, Lancia Dadra 2.0, Ei Tur (93), Delta 1.6 Gti, Nissan, Peugeot, Renault, Seat, Subaru, Volvo V40 6S40.
- J
- K Citroën C5
- K1 Citroën
- K2 Citroën, Renault.
- M Ford
- N Saab, Honda
- O Plate

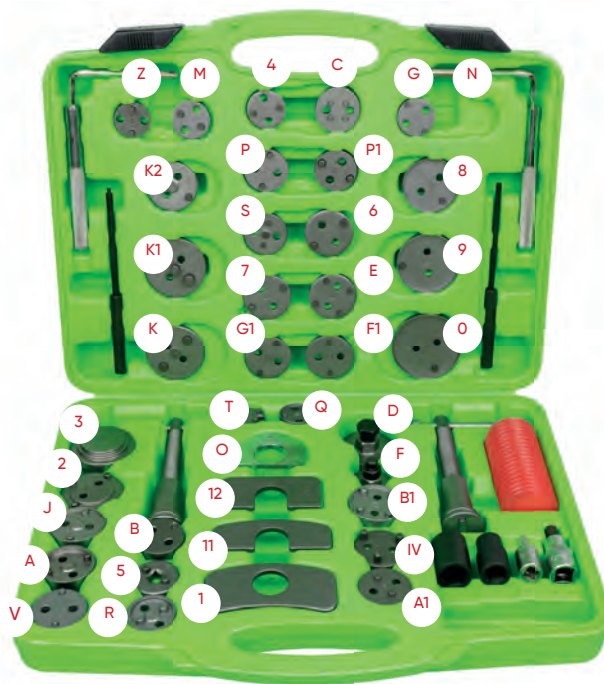

- P Audi, BMW, Ford, Lancia, Piston, Renault, Rover.
- P1 Peugeot 307,308.
Alfa Romeo 164 2.0 1., Fiat Uno, Turbo ie-Barchetta, Ford Escort MK III, IV, Orion, XR31, Focus(98-) push-back pistons, Honda-most models (push-back pistons), Rover-most models(push-back pistons), Subaru Lserie & Serie 2
Ford(Australia& NZ) Teslar, Laser, Mazda 323 Gti, GTXX (86), 929 (82.), RX7(81-), 626
R 16V(87-) 626 GT (86-), 929 V6 (88-), Mitsubishi Galant GL Si, Toyota Celica, Corolla GT, MR2
Audi 100 TQ(91), BMW 740i 8cyl (91), Lancia Delta 1.9 TD (95), Proton 416, Renault-most models, Renault Laguna 2.0 (94), Laguna 2.2 D (95) Safrane 2.0-2.2 TD V6, Rover 623 Si, Volkswagen Golf Gtu Mk I&IV, Passat VR6, Vento GT (92)
- S
- T Rover 220 C Turbo (95)
- V Rover 216 Gti 16V,820 Si 2.0(93),825 SD 2.5 (93)
- Z Renault
- IV Iveco Daily, Volkswagen Passat 2.0 TDI 09-

53978

38,90€

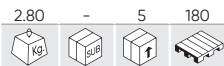

23 PCS BRAKE PISTONS REWINDING TOOL SET

0	General Motors (Ø pistons 2-1/2")
1	Disc
2	Citroën XM, Xantia
3	Alfa Romeo, Audi, Austin, BMW, Ford, Honda, Jaguar, Mercedes-Benz, Mitsubishi, Nissan, Rover, Toyota, VW
4	Alfa Romeo 164 2.0, Ford, Mazda, Saab 9000, Subaru
5	3/8" Antriebs-Adapter
6	Nissan Primera, VW.Golf IV
7	Audi 80;90;V8+100, Ford Sierra ABS+Scorpio de 1985, Honda Prelude, Nissan Silvia 1.8 turbo, Rover 8000, Saab 9000, Subaru L+Z, VW Golf + Passat
8	General Motors (Ø pistons 1-7/8")
9	General Motors (Ø pistons 2-1/8")
10	VW
K1	Citroën
A	Renault R21, Laguna
K2	Citroën
E	Nissan Maxima, Cefiro
M	Ford
F	Opel
N	Saab, Honda
K	Citroën C5
O	Plate

J Fiat Tipo TD 16V, Uno Turbo(85) Crama TD, Honda CRX, Alfa Romeo 155 1.8-2.0i, 164 TD (93), 164 3.0 V6 (91), Audi 80, 90, & V8's, A3, A4, A6, A8 (pinza trasera); Citroën ZX 2. Qi 16v; Fiat Tipo TD 16V, Uno Turbo (85-), Crama TD; Ford Sierra (ABS bak), Granada (85-); Ford (Australia & NZ) Thunderbird Turbo; Honda CRX, 1.6i-16V (88-90), Accord 1800 (84-85), 2.0i (86-), Preludi 16V (88-), LegendV6; Jaguar XJ serie 40; Lancia Dedra. 2.0 Ei Tur(93), Delta 1.6 Gti. (92), The. majE 16v(92), Thema. 2000 Turbo. Kappa 2.Q-2.4LS, 2.4TD;

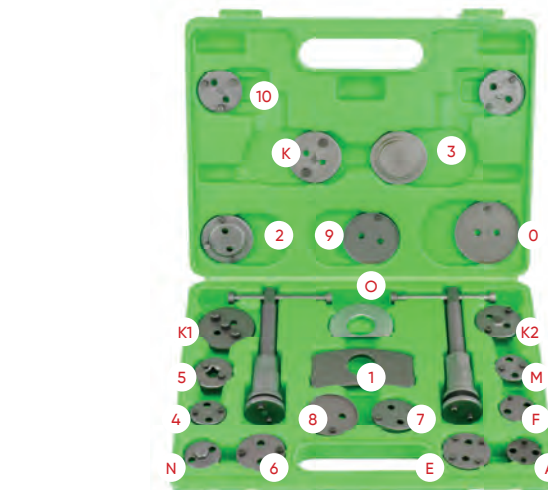

J Nissan 280 ZX (82-84), 300 ZX Turbo (84-89), Bluebird 16V (89-), Silvia 1.8 Turbo (85-88) 100 NZ 2.0 (93), Primera 2.0 GT (94), 200 SX turbo 16V, Maxima 2.0 GX-3.0 GX (95); Peugeot 306; Peugeot 309 Gtj 16S (91), 405. Srif Q. rj, Gil (87-), 405 M.1 16v; Renault Master Van; Rover 216 Gti 16V, 820 Si 2.0 (93), 825 SD 2.5 (93); Saab 9000 CS 2.0(93), 9000 CSE Turbo(93); Seat Toledo GT. 16V-GT 2.0(93), Ibiza 1.8 Gti 16V(95); Subaru Lserie & Serie 2; Volkswagen Passat 2.0 & 2.2 Litre(84), Golf Rallye (-89), Golf II Gti 16V(89-), Vento GT (92), Transporter T4; Volvo S40 & V40

51059

99,00€



BRAKE PISTONS REWINDING TOOL SET

0	Plate
1	Disc
2	Citroën XM, Xantia (F/R)
3	Alfa Romeo, Audi, Austin, BMW, Ford, Honda, Jaguar, Mercedes-Benz, Mitsubishi, Nissan, Rover, Toyota, VW.
4	Alfa Romeo 164 2.0, Ford, Mazda, Saab 9000, Subaru.
5	3/8" Antriebs-Adapter
6	Nissan Primera, VW-Golf IV.
7	Audi 80,90,V8 +100, Ford Sierra ABS+Scorpio ab 85, Honda Prelude Nissan Silvia 1.8 turbo, Rover 8000, Saab 9000, Subaru L+Z, VW-Golf +Passat.
8	General Motors (Ø pistons 1-7/8")
9	General Motors (Ø pistons 2-1/8")
11	Disc for Jaguar S type.
12	Disc for BMW mini
A	1-3/16" Two Pin Disc for Renault R21, Laguna.
B	Ford, Lincoln, Subaru.
C	Mini Austin
D	Citroën, Renault.
E	Cefiro, Maxima
F	Opel Corsa, Astra, Zafiraand Vectra
G	Opel (Rear Disk)
J	Alfa Romeo 155 1.8-2.0 164 TD(93) 164 3.0 V6(91) Audi,80,90,A3,A4,A6,A8 Citroen ZX 2 Qi 16V,Fiat Tipo TD 16V,Uno Turbo(85) Crama TD, Ford Sierra(ABS bak),Granada (85),(Australia & NZ) Thunderbird Turbo,Honda CRX,1.6i-16V (8-90),Accord 1800(84-85)2.0i,Prelude 16V(88),Legend V6,Jaguar XJ40series,Lancia Dedra 2.0 Ei Tur(93),Delta 1.6Gti,Nissan,Peugeot, Renault,Seat,Subaru,Volvo V40& S40.
K	Citroën C5
K1	Citroën, Renault.
K2	Citroën, Renault.
M	Ford
N	Saab,Honda. Z: Renault
O	GM Motors.
P	Audi, BMW, Ford, Lancia, Proton, Renault, Rover, VW
R	Ford (Australia & NZ) Telstar,Laser, Mazda 323 Gti,GTX(86-),929(82-),RX7(81-),626 16V (87-), 626 GT (86-),929 V6(88-),Mitsubishi Galant GL Si, Toyota Celica,Corolla GT,MR2. Audi 100TQi(91), BMW 740i 8cyl.(91), Lancia Delta 1.9 TD(95), Proton 416, Renault-most models, Renault Laguna 2.0 (94), Laguna 2.2 D(95), Safrane 2.0-2.2 TD V6, Rover 623 Si, Volkswagen Golf Gti Mk 3&4,Passat VR6,Vento GT(92).



Z BMW, Mini

Right rotating caliper (With right side thread)

Left rotating caliper (With left side thread)

Pin Ø 3.0 / Pin Ø5.5 (100g Grease)

52906

38,00€



BRAKE PISTONS REWINDING TOOL SET UNIVERSAL



REF. DESCRIPTION

REF.	DESCRIPTION	Weight (kg)	Volume (L)	Quantity	Price (€)
12974	SPARE 2 PINS FOR REF. 52906	0.50	-	50	21,00€
12975	SPARE 3 PINS FOR REF.52906	0.17	-	50	23,00€

ALFA ROMEO 164 2.0, FORD, MAZDA, SAAB 9000, SUBARU, NISSAN PRIMERA, VW, AUDI, FORD SIERRA ABS + SCORPIO AB 85, HONDA PRELUDE, NISSAN SILVIA 1.8 TURBO, ROVER 8000, SAAB 9000, FORD, OPEL, BMW, LANCIA, PROTON, RENAULT, ROVER, PEUGEOT 307, 308 A3- IVECO DAILY, VOLKSWAGON PASSAT 2.0 TDI 09, RENAULT LAGUNA.

53683

116,00€

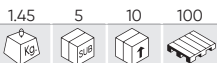

LOW PROFILE BRAKE CALIPER

- Working pressure: 5-8 BAR.
- Max. pressure: 14 BAR.
- Air inlet: 1/4".
- Magnetic disc holder.
- Workable with 2 and 3 pins discs.



51283

78,00€

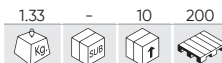

AIR BRAKE PISTON WIND BACK TOOL TIRE

- Working pressure: 5-8 BAR.
- Max. pressure: 14 BAR.
- Air inlet: 1/4".
- Magnetic disc holder.
- Workable with 2 and 3 pins discs.



52191

198,00€

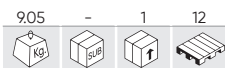

PROFESSIONAL BRAKE BLEEDER + MASTER CYLINDER

5L

- Adjustable working pressure: from 0 to 4 Kg/cm²
- Entrance & Exit plugs.
- Weight: 5 Kg.
- N° of adapters: 11.
- Application range: GM, Chrysler, Nissan + 2 universal adapters.



REF. DESCRIPTION

52328 CYLINDER ADAPTER MASTER KIT FOR REF.52191

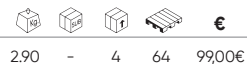

52434

125,00€



15 PCS

BRAKE MAINTENANCE/REPAIR SET

- x2 Brake line flare nut wrenches
- x1 Brake springs pliers
- x1 Screwdrivers with impact
- x3 Screwdrivers sockets
- x1 Assembly tool
- x1 Screwdrivers socket with universal joint
- x1 Special tool for brakes
- x1 Brake calliper brush
- x1 Brass brake calliper brush
- x1 Brake cable springs pliers
- x1 Brake clipper file
- x1 Flat scraper for removing crude residues



54135

82,00€

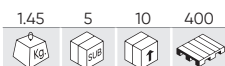

17 PCS

BRAKE CALLIPER SOCKET SET

CONTAIN

	x2	14x38, 22x38mm
	x3	11,50x38, 15x38, 20x38mm
	x4	10, 12.50, 14, 19mm
	x1	10mm
	x4	H11x100, H7x70, H7x92, H9x50mm
	x2	7x24, 8x24mm
	x1	9x20mm



AUDI (A4, A5, S5, S8, Q5, Q7), PORSCHE (CAYENNE, MACAN, CAYMAN), MERCEDES BENZ, FORD, BMW, ALFA ROMEO

BRAKES

54372

157,00€



N

BRAKE TESTER KIT WITH AND WITHOUT ABS

Designed for uninstalling the brake callipers when replacing brake pads.

APPLICATIONS

Audi (TT (2007-), A4 (2001-), A6 (2005-), A8 (2003-), Q7, S5, S6, S8), Porsche (Cayenne, Macan, Cayman), Mercedes-Benz (ML320, Clase C), Ford (Mondeo, Fiesta, Focus, Edge), BMW (Series 3 -generación E36 / 5), Alfa Romeo, Jaguar (XF), Vauxhall, Volkswagen, Chrysler, Mini, SAAB

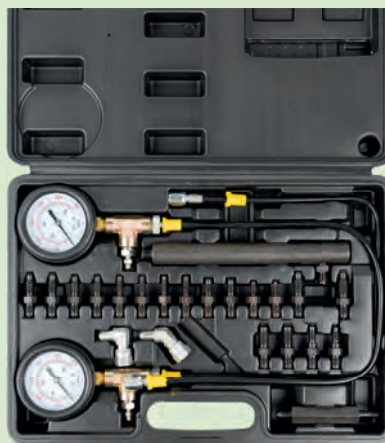

CONTAIN

- x1 Teves Adapter
- x1 45°Swivel Fitting
- x1 90°Swivel Fitting
- x2 7/16-24 Straight Fitting
- x2 1/4-28 Straight Fitting
- x2 3/8-24 Straight Fitting
- x2 5/16-24 Straight Fitting
- x2 M10-1.5 Straight Fitting
- x2 M8-1.25 Straight Fitting
- x2 M10-1.0 Bleeder Adapter
- x2 7/16-20 Straight Fitting
- x2 M7-1.0 Straight Fitting

52625

9,00€

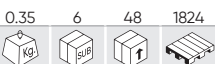

BRAKE SHOE SPRING PLIERS

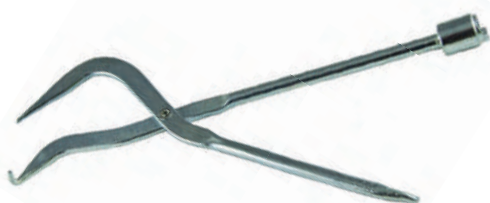

- For removing and installing return springs on brakes where the return.

52315

16,00€

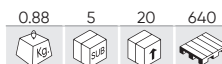

DISC BRAKE PISTON SEPARATOR



51839

24,00€

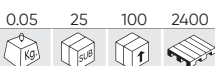

BRAKE FLUID TESTER

- Operates with 1 x AAA batteries LR03.
- With 4 levels of measurable quality from 0-4%.



52455

16,00€

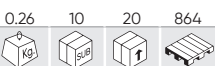

GAUGE FOR BRAKE PADS

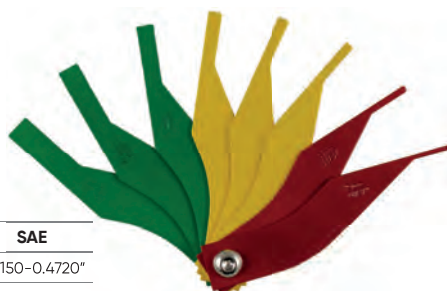

COLOUR	METRIC	SAE
Green	8-10-12mm	0.3150-0.4720"
Yellow	4-5-6mm	0.1575-0.2382"
Red	2-3mm	0.0787-0.1181"

52275

38,00€



UNIVERSAL BRAKE BLEEDING SET



- Work temperature: 10°C to 50°C.
- Silicone hose: 2m.
- Entrance air blowing pistol 1/4".
- Work pressure: 6-12 bar (87 - 174 psi).
- Air consum: 180l/min.

SPECIAL TOOLS

- 200 LUBRICATION SYSTEM
- 206 INJECTOR PULLERS
- 213 BLOCK/CYLINDER HEAD
- 216 CLUTCH
- 217 COOLING SYSTEM
- 219 A/C SYSTEM
- 221 TRANSMISSION
- 223 SUSPENSION
- 229 EXHAUST
- 231 ELECTRICAL SYSTEM
- 235 THREAD REPAIR
- 238 MOTORCYCLE
- 238 EXTRACTORS



SPECIAL TOOLS

54068

120,00€



19 PCS ALUMINIUM OIL FILTER CUP WRENCH SET

REF.	PIECE N°	DESCRIPTION	FLATS x Ø	kg	box	pieces	€
15494	05101	Mazda, Mitsubishi	15 x 100,5mm	0.18	-	50	12,50€
15495	0595	Nissan, Toyota	15 x 94,5mm	0.18	-	50	12,50€
15496	0592	Nissan, Subaru	15 x 92mm	0.18	-	50	11,50€
15497	0579	Toyota, Honda, Mitsubishi, Subaru, Mazda, Lsuzu	15 x 79mm	0.14	-	50	11,00€
15498	915	Volvo	16 x 87mm	0.24	-	50	11,50€
15499	901L	Lexus	14 x 79,5mm	0.15	-	50	11,00€
15500	901T	Toyota	14 x 70mm	0.13	-	50	10,00€
15501	901-1	Toyota	14 x 63-64mm	0.10	-	50	10,00€
15502	902	Ford, Mazda	14 x 66,5mm	0.89	-	50	10,00€
15503	1284	Dodge Sprinter (2007-), Mercedes Benz E320 (2007-), Jeep Cherokee 3.0L V6 Common Rail (2007-)	14 x 84mm	0.13	-	50	11,00€
15504	903B	Mercedes Benz	14 x 74mm	0.13	-	50	10,00€
15505	24mm	BMW 5, BMW 7, BMW X5 V8 (N62) (2004-), Saturn (2008), Astra 1.8L ECOTEC, Chrysler 3.6L V6 (2011-), 200, 300, T/C Dodge Jeep	6 x 24mm	0.47	-	50	4,00€
15506	27mm	Mercedes Benz Clase A	6 x 27mm	0.45	-	50	4,00€
15507	30mm	Audi A2, Vw Polo, Lupo 1.4L/1.6L	6 x 30mm	0.44	-	10	4,50€
15508	32,5mm	Opel Astra G, Corsa B, Zafira, Audi, VW 1-36 mm, Opel Omega, Vectra B, Zafira (98-), BMW M43/60)	6 x 32,5mm	0.45	-	50	4,50€
15509	36mm	Opel Omega, Vectra B, Zafira (98-), BMW M43/60, Mercedes Benz Vito CDI, C, E, VW Lupo 1.2 TDI, MAN	6 x 36mm	0.48	-	50	5,00€
15510	38mm	Opel Vectra 2.0D	6 x 38mm	0.50	-	50	5,00€
15511	917	Universal	55-90mm	0.22	-	50	8,00€



51332

98,00€



OIL FILTER CUP AND WRENCH SET

REF.	PIECE N°	DESCRIPTION	FLATS x Ø	kg	box	pieces	€
11374	901	Toyota, Nissan, Fiat Daihatsu	14 x 65mm	0.05	5	20	5,50€
11375	902	Toyota, Daihatsu	14 x 67mm	0.45	5	20	6,50€
11376	903	VW, Mercedes, BMW, Opel, Audi	14 x 74mm	0.20	5	20	5,50€
11377	903-1	GM/AC, Wix, Ford, Isuzu	15 x 75mm	0.09	5	20	5,50€
11378	903-2	VW, Audi, Seat, BMW, Renault	8 x 74mm	0.09	5	20	6,50€
11379	903-3	Audi, Rover, Chrysler	15 x 74mm	0.11	5	20	6,00€
11380	903-4	Toyota, Lexus	14 x 73mm	0.11	5	20	6,50€
11381	903-6	Schlepper, Baumashinen	12 x 75mm	0.10	-	20	6,50€
11382	918	Rover, Chrysler, Audi	15 x 74mm	0.11	5	20	6,00€
11383	904	Nissan, Ford	15 x 79mm	0.50	5	20	6,00€
11384	905	GM, Chrysler	15 x 73mm	0.12	5	20	6,00€
11385	905-1	BMW, Mercedes, Opel, Audi, VW	14 x 74mm	0.10	5	20	5,50€
11386	906	Baummaschinen, Schlepper	18 x 84mm	0.10	5	20	6,00€
11387	907	Mitsubishi, Toyota	15 x 89mm	0.13	5	20	6,00€
11388	908	Nissan, Toyota	15 x 91mm	0.14	5	20	6,00€
11389	915	Honda Accord, Mitsubishi, Isuzu	15 x 90mm	0.16	5	20	6,00€
11390	910	Toyota, Alfa Romeo, Ford	15 x 95mm	0.12	5	20	6,00€
11391	911	Fiat, Renault, Citroën	12 x 76mm	0.09	5	20	6,50€
11392	911-1	Subaru, Toyota, Honda, Nissan	15 x 80mm	0.09	5	20	6,00€
11393	914	Mazda, Toyota	15 x 101mm	0.18	5	20	6,00€
11394	909	Isuzu, Nissan	15 x 92mm	0.14	5	20	6,00€



REF.	DESCRIPTION	kg	box	pieces	€
14992	12-EDGE KEY FOR REF. 51332 / REF. 14141	0.14	-	100	8,50€
10955	1/2 *RATCHET FOR FILTER EXTRACTOR 51332	0.14	-	50	11,00€

OIL FILTER CUP WRENCH

REF.	FLATS x Ø	DESCRIPTION					€
52311	42mm	GRUPO VAG	0.13	6	72	1728	19,00€
52312	14 x 74mm	VW, OPEL, MERCEDES, BMW, AUDI	0.10	10	100	1000	9,00€
52313	16 x 86mm	VOLVO 540, 560, 570, 580	0.20	6	68	1008	8,00€
52314	16 x 87mm	BMW, VOLVO	0.20	5	50	600	26,60€
52809	14 x 64,5mm	TOYOTA	0.15	10	100	1000	8,50€
53441	14 x 76mm	-	0.20	5	20	800	9,80€



53008

15,50€

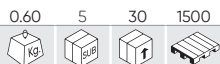

OIL FILTER WRENCH FOR FORD, CITROËN, PEUGEOT 2.0, 2.2 HDI, TDCI



52518

115,00€

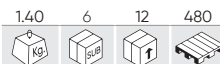

TRUCK FILTER WRENCH 95-165MM



52615

112,00€



9 PIECES OIL FILTER WRENCH SET

9 PCS

- Adjustable double key.
- Application range: 60-80mm.

1/2"	x1	Universal	63 - 83mm
		Mercedes Benz, Smart	27mm
	x3	GM, Opel, Vauxhall, Mercedes Benz	32mm
		Mercedes Diesel, BMW, Mini, Ford	36mm
		Toyota (Allion, Auris, Corolla, Prius, Voxy, etc.)	64,5mm
3/8"	x3	Toyota, Lexus (6 Zyl.).	64,5mm
		Audi, BMW, Ford, Toyota, Volkswagen, Porsche, Mercedes-Benz	74,2mm
	x1	Hunday, Kia.	88,8mm
	x1	BMW 3+5+X, Volvo	86,6mm



3 LEG OIL FILTER WRENCH WITH FLAT / ROUND LEGS

51352

9,80€



1/2" - 3/8"
57-118mm
Ø2-1/4" ~ 5"

51353

11,50€



1/2" - 3/8"
72-136mm
Ø2-1/2" ~ 4"

51923

12,50€



1/2" - 3/8"
72-136mm
Ø2-1/2" ~ 4"

51934

11,50€



1/2" - 3/8"
57-118mm
Ø2-1/2" ~ 4"

SPECIAL TOOLS

53206

38,20€

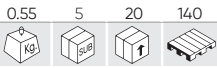

**5
PCS**

5 PCS BENZ/AUDI ENGINE & TRANSMISSION DIPSTICK SET

- For checking the oil transmission fluid on Audi 100 engines:
- The tip (first 11mm) is the 20°C cold fluid reading.
- The second reading is the minimum at 80°C .
- Third reading is at max 80°C.
- Maintain vehicle level when checking ATF.
- Engine dipstick for checking the oil level, compatible with a large selection of 1988 to 2005 engines in the Mercedes range.



	Mercedes-Benz	920mm	- Transmission code: 716.5,722.7,722.8.
	Mercedes-Benz	930mm	- Year of manufacture: 1988-1997. - Engine Codes: 103,104,111,119,120,137,604,605,606,611,612,613,628,642,647,648.
	Mercedes-Benz	930mm	- Year of manufacture: 1996-2005. - Engine Codes: 103,104,111,112,113,119,120,137,271,272,604,605,606,611,612,613,628,642,646,647,648.
	Mercedes-Benz	1200mm	- Transmission code: 722.6.
	Audi	1160mm	- AUDI 100 engines

REF.	DESCRIPTION					€
13856	AUDI ENGINE TRANSMISSION DIPSTICK	0.04	5	100	-	7,80€

51354

13,20€

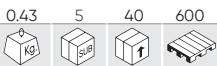

REMOVAL OIL FILTER TOOL

80-120mm

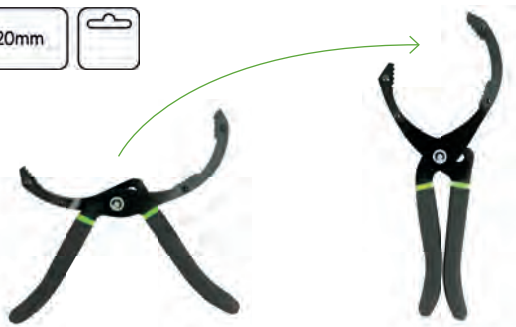

53670

29,50€

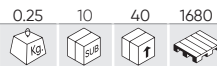

OIL FILTRE WRENCH FOR DSG/VAG 1/2" 24MM

1/2"

- Special tool designed for the assembly and disassembly of the oil filter of DSG gear.
- Its reduced size allows to reach easily the oil filter of DSG gear without remove any battery.



52269

7,00€

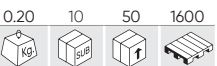

OIL FILTER WRENCH BAND

80-120mm

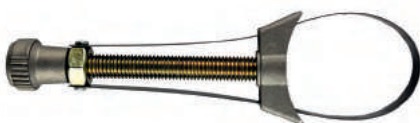

52677

17,00€



ADJUSTABLE FILTER REMOVAL WRENCH Ø65-105MM

Ø65-105mm



52678

18,00€

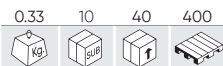

ADJUSTABLE FILTER REMOVAL WRENCH Ø110-155MM

Ø110-155mm



REPLACEMENT

REF.	mm				€
11106	360mm	0.02	10	50	3,00€

REPLACEMENT

REF.	mm				€
11936	383mm	0.15	5	300	4,00€

REPLACEMENT

REF.	mm				€
11937	540mm	0.04	10	100	5,00€

OIL FILTER WRENCH

<p>52417 28,00€</p> <p>0.90 5 25 800</p> <p>Ø160-300mm</p> <p>HIGH STRENGTH CHAIN</p>	<p>52416 14,00€</p> <p>0.37 5 50 900</p> <p>Ø150-540mm</p> <p>POLYMER STRAP (HIGH RESISTANCE)</p>	<p>52607 49,00€</p> <p>0.85 6 24 576</p> <p>Ø60-140mm</p> <p>ARTICULATED DOUBLE CHAIN</p>	<p>52608 44,00€</p> <p>0.95 6 24 480</p> <p>Ø60-195mm</p> <p>ARTICULATED DOUBLE CHAIN</p>
--	--	--	--

53735 44,00€

1.70 - 5 375

OIL DRAIN PLUG SOCKET SET OF 23PCS

CONTAINS

	x2	5/16", 3/8"
	x7	7, 8, 10, 11, 12, 13, 14mm
	x1	10mm
	x1	10mm
	x7	8, 9, 10, 12, 13, 14, 17mm
	x1	T45
	x1	M16
	x1	200mm
	x2	75, 150mm

23 PCS 3/8"

15084 68,00€

1.86 - 5 -

EVA TRAY DRAIN PLUG KEY SET

CONTAINS

	x2	5/16", 3/8"
	x7	7, 8, 10, 11, 12, 13, 14mm
	x1	10mm
	x1	10mm
	x7	8, 9, 10, 12, 13, 14, 17mm
	x1	T45
	x1	M16
	x1	200mm
	x1	150mm

240mm 135mm 32mm

ALSO SUITABLE FOR OIL PANS 53873 AND 53874.

OIL PAN DRAIN SUMP PLUG KEY

<p>53235 10,40€</p> <p>0.25 10 40 -</p> <p>M13</p>	<p>53236 11,50€</p> <p>0.35 10 40 -</p> <p>M15</p>	<p>53237 12,90€</p> <p>0.35 10 40 -</p> <p>M17</p>	<p>53238 18,40€</p> <p>0.40 10 40 -</p> <p>M20</p>
---	---	---	---

SPECIAL TOOLS

SET OF 5 OIL DRAIN PLASTIC PLUGS

5
PCS

REF.	DESCRIPTION					€
13969	VAG	0.02	10	100	-	19,00€
53537	BMW	0.05	10	100	4000	14,50€
53538	Ford	0.10	10	100	4000	14,50€
53741	Ford / PSA	0.05	10	100	4000	14,00€



53472 12,00€

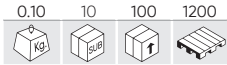

PLASTC OIL DRAIN PLUG WRENCH (VAG)



52617 7,00€

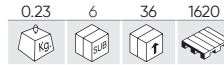

SPECIAL OIL DRAIN PLUG WRENCH

- For Citroën, Renault, Peugeot.



53473 36,00€

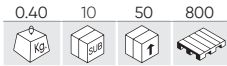

PLASTIC OIL DRAIN PWG DRIVER SET



5
PCS

A	x1	3/8"	80x100mm	Ford	OEM 1830727
B	x1	1/4"	1,5mm	VAG	OEM 06L 103 801
C	x1	1/4"	10mm	BMW	OEM 11137605018
D	x1	3/8"	3mm	Peugeot/Citroën	OEM 9801444780/OEM18711598
E	x1	1/4"	- 3/8"		

52754 54,00€

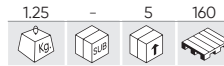

COMPRESSION TESTER KIT OIL

0-10
BAR

0-140
PSI

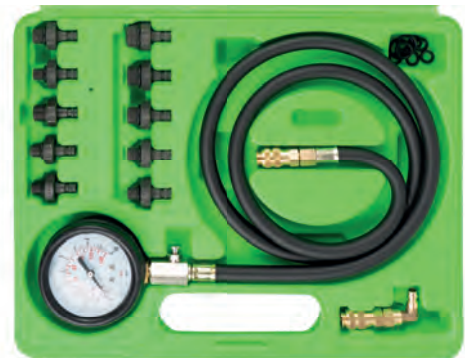

x1	M10x1.0mm
x1	M12x1.5mm
x1	M14x1.5mm
x1	M16x1.5mm
x1	M18x1.5mm
x1	1/8" DIN 2999
x1	1/8" x 27 NPT
x1	1/4" x 18 NPT
x1	3/8" x 20 UNF
x1	1/2" x 20 UNF

51337 50,00€

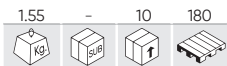

OIL DRAIN PLUG REPAIR SET

24
PCS

- SKS3 plugs.
- 1015 bits.
- Copper washers.

CONTAINS

- M13x1,5P
- M13x1,5P
- M13x1,5P
- M20x1,5P
- Bits: 1 unit per measurement
- Plugs: 5 units per measurement
- Washer: 10 units per measurement

SPARE PARTS AVAILABLE

	REF.	DESCRIPTION				€
	A 51400	M15 x 1.5P	0.15	50	100	17,00€
	B 51401	M17 x 1.5P	0.14	50	100	22,00€
	C 51402	M20 x 1.5P	0.10	25	50	20,50€
	D 51403	M13 x 1.5P	0.15	50	100	17,50€
	E 14930	M13 x 1.5P	0.05	10	100	9,50€
	F 14931	M15 x 1.5P	0.05	50	100	8,00€
	G 14932	M17 x 1.5P	0.07	5	100	9,50€
	H 14933	M20 x 1.5P	0.10	5	100	9,50€

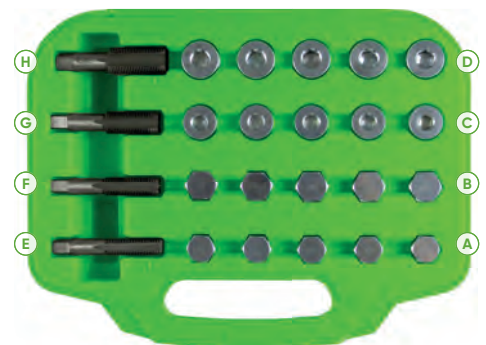

53485

140,00€

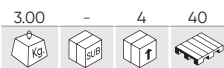

ENGINE OIL FILLER FUNNEL SET



- A Threaded adaptor M42 x 4.5 for Subaru
- B Threaded adaptor M37 x 3.0 (short type) for Lotus, Pontiac, Scion, Toyota
- C Threaded adaptor M35 x 4.0 for Ford, Jaguar, Land Rover, Mazda
- D Threaded adaptor M32 x 3.5 for Acura, Dodge, Ford, Honda, Jaguar, Jeep, Land Rover, Mazda, Nissan
- E Bayonet adaptor for Toyota & Lexus 3.0 & 3.3l V6
- F Bayonet adaptor for Audi, BMW, Mercedes-Benz, Porsche, Volvo, VW
- G Threaded adaptor M30 x 3.0 for Dodge Cummins
- H Threaded adaptor (1/2 turn) for Mazda 3 / 6 / CX-5
- I Threaded adaptor (1/2 turn) for Cadillac, Chevy, Ford, GMC, Hyundai, Jaguar, Land Rover, Mazda, Saab, Mercury
- J Threaded adaptor (1/4 turn) for new oil filling lids as of 2008 on Audi, Seat, Skoda, VW with EA888 engine
- K Threaded adaptor (1/2 turn) for Dodge Hemi 6.4L (2011-) & >3.6L (>2014)
- L Threaded adaptor M37 x 3.0 (long type) for Lotus, Pontiac, Scion, Toyota

53347

100,00€



OIL FILLING SET WITH FUNNEL AND ADAPTERS



- A Threaded adaptor M42 x 4.5 for Subaru
- B Threaded adaptor M37 x 3.0 (short type) for Lotus, Pontiac, Scion, Toyota
- C Threaded adaptor M35 x 4.0 for Ford, Jaguar, Land Rover, Mazda
- D Threaded adaptor M32 x 3.5 for Acura, Dodge, Ford, Honda, Jaguar, Jeep, Land Rover, Mazda, Nissan
- E Bayonet adaptor for Toyota & Lexus 3.0 & 3.3l V6
- F Bayonet adaptor for Audi, BMW, Dodge, Mercedes-Benz, Porsche, Volvo, VW

52305

106,00€



GLOW PLUG REMOVAL SET

16 PCS



- This set is useful for removal of broken or obstructed heater.
- Universal and ideal for Mercedes Benz CDI engines.
- It removes of broken or obstructed M8 M10 taps.
- It includes 1/4" M8 taps and high resistance-double size M8 and M10 step bit.

51494

107,00€



INJECTOR PULLER SET

9 PCS S



- | | | | | | |
|--|------------|------------|--|----------------------|----------|
| | M12 x 1.75 | M8 x 1.5 | | M14 x 1.5 | M8 x 1.5 |
| | M14 x 1.5 | M17 x 1.5 | | M14 x 1.5 | |
| | M14 x 1.5 | M27 x 1.0 | | HRC: Hardness 30 -35 | |
| | M14 x 1.5 | M12 x 1.75 | | 1.75Kg. | |
| | M14 x 1.5 | M8 x 1.5 | | | |

54186

250,00€



PNEUMATIC INJECTOR PULLER

6-8 BAR | S | 20-30 Nm | BOSCH, DELPHI, DENSO, SIEMENS

REF.	DESCRIPTION	kg	Sub	Units	€
16366	M20X1,0 10MM	0.13	-	30	11,00€
16367	M10X1,5 14MM	0.08	-	30	10,00€
16368	M14X1,5 15MM	0.10	-	30	12,00€
16369	M14X1,5 33MM	0.12	-	30	12,00€
16370	M16X1,5 18MM	0.10	-	-	12,00€
16371	M17X1,0 10MM	0.11	-	30	11,00€
16372	M18X0,75 10MM	0.10	-	30	11,50€
16373	M18X1,5 18MM	0.10	-	30	12,00€
16374	M22X1,5 15MM	0.10	-	30	12,00€
16375	M25X0,5 9MM	0.10	-	30	15,00€
16376	M25X1,0 13MM	0.10	-	30	15,00€
16377	M26X0,75 15MM	0.10	-	30	16,00€
16378	M27X0,75 10MM	0.10	-	30	15,00€
16379	M29X1,0 11MM	0.10	-	30	15,00€
16380	M31X0,75 15MM	0.12	-	30	16,00€

REF.	DESCRIPTION	kg	Sub	Units	€
16381	M8X1,0 14MM	0.09	-	30	10,00€
16382	M8X1,25 14MM	0.01	-	30	10,00€
16383	M14X1,5 9MM	0.13	-	30	15,00€
16384	M14X1,5 9MM	0.11	-	30	15,00€

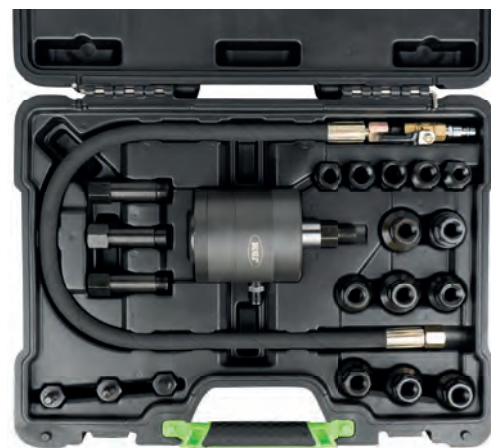

54345

15,00€

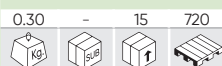

FREEZING SPRAY

-42° | 400ml
 UFI: MD82-13A7
 G004-V27H

Suitable to be used on metallic surfaces. It facilitates the contraction of the steel, making the extraction easier.



16295

30,00€



SET OF 3 ADAPTORS FOR PNEUMATIC INJECTOR PULLER (REF.54186)



52858

298,00€



INJECTOR EXTRACTOR PULLER SET

Hammers	1,6Kg (160mm)
	2,7Kg (460mm)
	5,1Kg (600mm)
Pulling claws with fork opening	13,7x18mm (105mm)
	12,7x19mm (130mm)
Slotted (6pt)	1/2" - 25, 27, 28, 29, 30mm (100mm)
Pulling adapter with external thread	M27x1.0
	M25x1.0
Injector extractor	M27x1.0
	M17x1.0mm
Pulling adapter with internal thread	Ø 35mm
	Ø 29mm
Slide hammer adapter for internal, external and claw extractor	

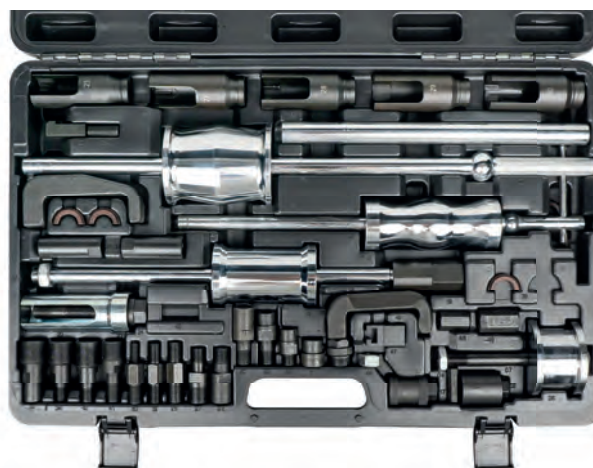

51493

68,00€

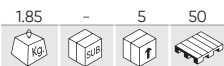

DIESEL INJECTOR FLOW TEST KIT

31 PCS BOSCH, SIEMENS, DENSO, DELPHI

The purpose of this instrument is to rapidly and efficiently measure the amount of fuel that each injector returns to the deposit tank so that you will know if an injector is damaged. Suitable for use in Bosch, Siemens, Denso and Delphi injector.

- CONTAINS**
- Hanger to hang with 6 graduated measurement bottles
 - Measurement tubes
 - Discount white tubes
 - Storage case



REF.	DESCRIPTION					€
12901	BOTTLE + CAP + HOSE FOR REF.51493	0.03	10	60	-	5,20€

54391

221,00€



DIESEL INJECTOR NOZZLE TESTER

0-60 MPA 5-8 BAR 0-600 BAR 0-8700 PSI M12 M14

This tool helps you check the condition of the injectors while applying pressure on them. It is specially indicated for checking the atomization pattern and the opening pressure of the injectors.

- x1 M12
- x2 M14



54392

1.855,00€

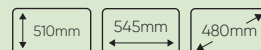
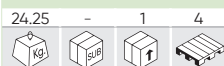

GDI / EFI INJECTOR CLEANER AND TESTER

220V 60W 50-60 Hz
 0,1-10 BAR 5-8 BAR
 <85% -10°C 40°C

This machine allows you to clean and check the correct functioning of GDI and EFI injectors. Thanks to its microcontroller, the machine can simulate real engine operating conditions, allowing the behaviour of each injector to be observed and possible faults to be detected.

For injector cleaning, it uses ultrasonic cleaning, thus guaranteeing the complete elimination of any residues that may be present in both petrol and diesel injectors. For EFI systems it also includes in-vehicle cleaning mode.

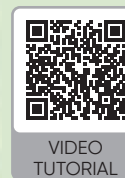

VIDEO TUTORIAL

SPECIAL TOOLS

54220

197,00€

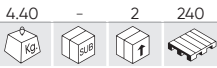

BMW FUEL INJECTOR PULLER / INSTALLER TOOL MERCEDES BENZ

APPLICATIONS	<p>BMW: 135iS (2008-), 335 (2007-), 335xi (2007-), 535i (2008-), 535xi (2008-), 550i GT (2010-), 750Li (2009-), 750i (2009-), X3 3.0i (2007-), X5 (2011-), X5 3.0i (2008-), X6 (2008-)</p> <p>MERCEDES-BENZ: C-CLASS (2007-), CLK / SLK (2007-), E-CLASS (2007-), A / CLA / GLA 45 AMG (2013-), CL / CLS 63 AMG (2010-), E / G / GL 63 AMG (2011-), GLE 63 AMG (2015-) S / SL 63 AMG (2010-), SLK 55 AMG (2012-)</p>
OEM TOOLS	<p>BMW: 130180(1), 130195(2), 130270(3), 130320(4), 2249115(5)</p> <p>MERCEDES-BENZ: 271589023300(6), 278589003300(7)</p>
ENGINE CODES	<p>BMW: N14 / N18 / N20 / N47 / N54 / N57 / N55 / N63</p> <p>MERCEDES-BENZ: M133 / M152 / M157 / M270 / M271 / M274 / M276 / M278</p>

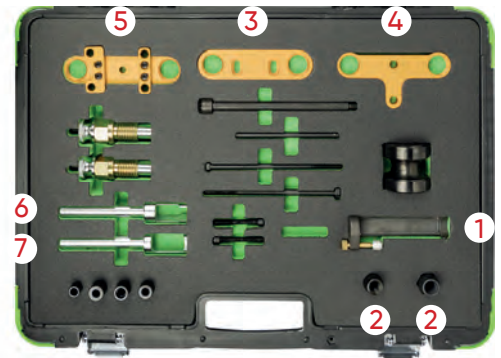

52815

110,00€

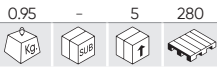

GLOW PLUG ELECTRODE REMOVAL TOOL SET

22
PCS



53250

85,00€



INTERNAL AND EXTERNAL BEARING PULLER SET

5
PCS



53069

98,00€

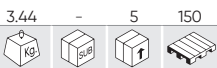







DIESEL INJECTOR PULLER SET FOR CITROËN, PEUGEOT

9
PCS

CITROËN, PEUGEOT



-  x1
-  x3
-  x2 Ø 17mm
-  x2 Ø 25mm
-  x2 25mm
-  x1 29mm
-  x1 21mm

52629

99,00€

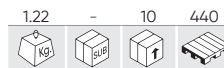

INJECTOR PULLER SET FOR MERCEDES

3
PCS

MERCEDES



M16x1.5

52639 123,00€

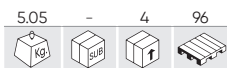

STEERING RACK KNUCKLE TOOL SET



53501 24,00€

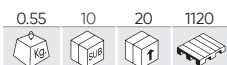

DIESEL INJECTION PUMP PULLER FOR BMW



OEM 1 13 5 191 | 13 5 192 | 13 5 190 BMW.
BWM: M47 / M47T2 / M47TU / M57 / M57TU.
SERIES: E46 (318D-320D) (1988 - 2005) and E60, E61 (318TD-320TD-525D-530D-530-535) (2000 - 2006).

53009 42,00€

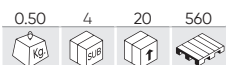

INJECTOR LINE SOCKET SET



53464 153,00€



INJECTOR COPPER RING ASSORTMENT 551 PCS

551 PCS



FOR FURTHER INFORMATION

PAGE 387



53522 24,00€

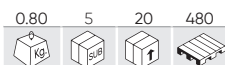

INJECTOR SEAL PULLER



53696 22,00€



LOOSENING TOOL FOR HENN-TYPE HOSE CLAMPS



VOLKSWAGEN, AUDI, SEAT, ŠKODA, BMW, PEUGEOT, CITROËN, DACIA, FIAT, FORD, KIA, LEXUS, MAZDA, MERCEDES, NISSAN, OPEL/VAUXHALL, PORSCHE, RENAULT, TOYOTA, VOLVO.

52757 16,00€



FUEL TANK SENDER WRENCH 3 LEG



53490 275,00€

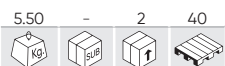

PETROL AND DIESEL COMPRESSION TEST KIT

	M24
	M20
	M24
	M20
	Ø 10, 12, 14, 18mm



53096 28,80€



FUEL TANK SENDER WRENCH

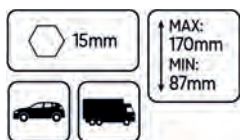

ALFA ROMEO, BMW, CHRYSLER, CITROËN, DAEWOO, FIAT, FORD, HONDA, HYUNDAI, ISUZU, JEEP, KIA, LADA, LANCIA, LAND ROVER, LDV, MAZDA, MERCEDES, MG, MITSUBISHI, NISSAN, PEUGEOT, RENAULT, ROVER, SAAB, SSANGYONG, SUZUKI, TOYOTA, VAG, VAUXHALL/OPEL, VOLVO

SPECIAL TOOLS

54373

395,00€

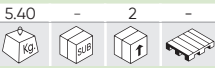

HIGH PRESSURE COMMON RAIL GAUGE



x2	M12x1,25	x6	M12x1,50
x2	M14x1,25	x6	M14x1,50

An essential tool for measuring the high pressure generated by the compression stroke in the air cylinder of a diesel engine. It has a variety of adapters for different specifications and connections that can measure different types of diesel engines



N

54312

191,50€



COMPRESSION TESTER DIESEL



SPARK PLUGS
10, 12, 14, 18mm
ADAPTORS
M20, M22, M24

ALFA, BMW, FIAT, FORD, LDV, PSA, RENAULT, SUZUKI, SAAB, CHRYSLER, DAEWOO, HYUNDAI, MERCEDES, MITSUBISHI, NISSAN, LANDROVER, MAZDA, ISUZU, OPEL.



N

52599

230,00€



FUEL PRESSURE TESTER

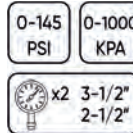

52489

58,00€

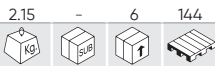

COMPRESSION TEST DIESEL

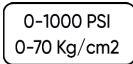

M18x1.5mm
M24x1.5mm
M24x2.0mm
M10x1.0x68mm
M10x1.25x45mm
M10x1.25x54mm
M10x1.25x68mm

FORD, BMW, MERCEDES BENZ, VW, CITROËN, MITSUBISHI, TOYOTA, PEUGEOT, RENAULT, VOLVO, MAZDA.

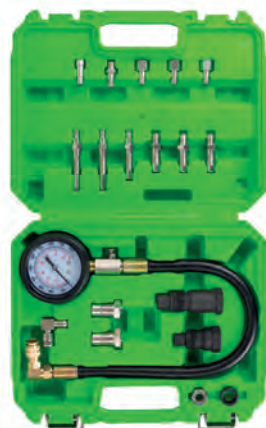

52685

88,00€

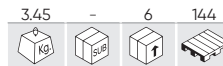

COMPRESSION TESTER DIESEL FOR TRUCKS



M18
M24



53997 48,00€

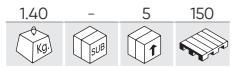

FUEL INJECTION PRESSURE TEST GASOLINE

0-10 BAR 0-140 BAR

LENGTH	25,5cm (1), 29,5cm (2), 110cm (3)
OUTER DIAMETER	1,2cm (1), 1,2cm (2)
INNER DIAMETER	0,6cm (1), 0,6cm (2)



54016 76,00€

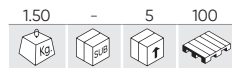

VACUUM AND PRESSURE TEST SET

MAXIMUM PRESSURE
40 PSI (3 BAR)
MINIMUM PRESSURE
-20 PSI (-0,75 BAR)



52488 28,00€

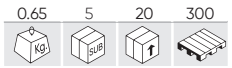

COMPRESSION TESTER KIT - GASOLINE

0-300 BAR
0-21 Kg/cm2



53489 68,00€

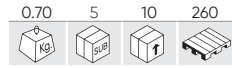

TURBO PRESSURE GAUGE

-1~3 BAR 2m



52076 111,00€

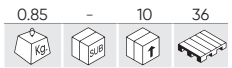

GLOW PLUG THREAD REPAIR SET

- 1 Insertion tools- 2 units
- 2 Handle for piece 8- 1 units
- 3 Thread M8 x 1.0- 5 Units
- 4 Thread M10 x 1.0-5 Units
- 5 Thread M10 x 1.25-5 Units
- 6 Thread M12 x 1.25-5 Units
- 7 Insertion heads - 3 units
- 8 Thread insertion rod - 1 Unit
- A Cutting insertion M14 x 1.25 (for M12 x 1.25 threads) - 1 unit
- B Cutting insertion M12 x 1.25 - 1 unit
- C Cutting insertion M12 x 1.0 (for M10 x 1.25 threads) - 1 unit
- D Cutting insertion M10 x 1.25 - 1 unit
- E Cutting insertion M10 x 1.0 (for M8 x 1.0 threads) - 1 unit
- F Cutting insertion M8 x 1.0 - 1 unit

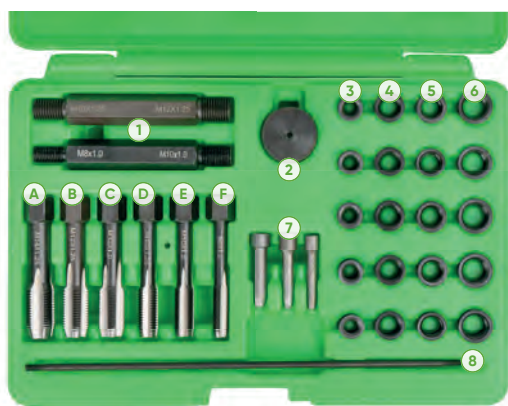

REF.	kg	units	€
11893 M8x1.0	0.01	5	7,00€
11894 M10x1.0	0.01	5	7,00€
11895 M10x1.25	0.02	5	8,65€
11896 M12x1.25	0.02	5	8,80€

SPECIAL TOOLS

52813 79,00€

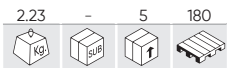

DIESEL INJECTOR SEAT CUTTER SET 17 PCS

17 PCS



	x8	14x14, 15x19, 15.5x15.5, 17x17x, 17x17.5, 17x19, 17x19.5, 17x20mm		x1	19x225mm
	x4	15.5x15.5, 17x17, 17.5x20.5, 17x21mm		x1	19x170mm
	x1	19x21.5mm		x1	19mm
				x1	2.5mm

52273 44,00€

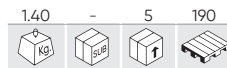

DIESEL INJECTOR SEAT CUTTER SET

8 PCS



	x3	15x19mm 17x17mm BMW, PSA, Renault, Ford 17x19mm Mercedes CRD		x1	12mm
	x2	17x17mm Mercedes 17x21mm Fiat/Iveco		x1	19mm
				x1	

53650 47,00€



INJECTOR SEAT CLEANING SET

19 PCS

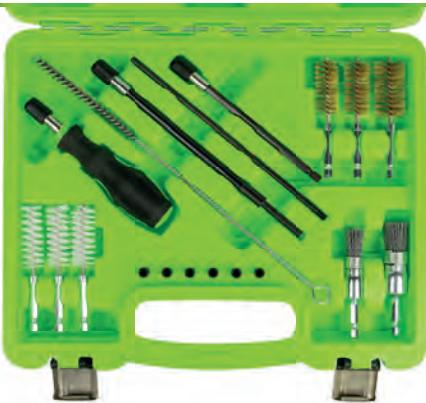

REF.	DESCRIPTION					€
14348	SET OF 3 BRASS CLEANING BRUSH (REF.53650)	0.05	-	50	-	12,50€
14349	SET OF 2 SILICON CLEANING BRUSH (REF.53650)	0.07	-	100	-	20,50€

53330 38,00€



VE PUMP SOCKET SET

5 PCS 1/2" 1/4" Cr-V



52801 26,00€



DIESEL PUMP PRIMING TOOL

1 PCS



52821 28,80€



DOUBLE OPEN END SPANNER FOR DIESEL INJECTOR PIPES

17mm



LETTERS AND NUMBERS

They allow numerical or alphabetical marking of all types of metal surfaces by pressing or tapping. The rounded finish of its end avoids the appearance of cracks or breaks in the worked surface.

52422 24,70€

0.82 3 6 540

1.94 3 6 504

A-Z & 0-9

36 PCS 3/16"

5mm

53119 52,00€

0.30 10 60 1500

A-Z & 0-9

36 PCS 5/16"

8mm

52882 14,00€

9 PCS 1/4"

6mm 0-8

51120 41,00€

2.10 - 5 120

VALVE SPRING COMPRESSOR SET

- Can be used for cars or motorcycles.
- The 5 adapters can be fitted correctly and easily to compress the valve spring.

CONTENTS
Spring compressor.
Adapters: 30, 25, 23, 19, 16mm.

52734 51,00€

2.61 - 5 175

VALVE SPRING COMPRESSOR 45-145MM

Ø 30mm Ø 25mm
45-145mm

52693 24,50€

0.65 5 20 450

VALVE SPRING COMPRESSOR REMOVAL TOOL

53251 88,00€

2.80 - 4 60

PISTON RING COMPRESSION SET

H:3" Ø 53-125mm
H:4" Ø 60-175mm
H:6" Ø 60-175mm

52697 16,00€

0.50 5 40 720

PISTON RING COMPRESSOR 6"

6" Ø 60-175mm

150mm

52696 12,00€

0.28 5 40 1200

PISTON RING COMPRESSOR 3"

3" Ø 53-175mm

77mm

SPECIAL TOOLS

PISTON RING PLIERS

REF.	DESCRIPTION					€
54273	40-100mm	0.30	6	30	-	10,10€
54274	80-120mm	0.35	6	30	-	11,00€
54275	100-160mm	0.40	6	30	-	13,20€



52591 **12,00€**

0.10 12 72 1728

BRAKE CYLINDER HONE 1 - 1/8"

1-18"
28,60mm
MAX: Ø 55mm
MIN: Ø 19mm



52592 **22,00€**

0.20 - 20 480

BRAKE CYLINDER HONE - 3 ARMS 2"

2"
50,80mm
MAX: Ø 85mm
MIN: Ø 35mm



52593 **34,00€**

0.47 6 36 648

BRAKE CYLINDER HONE - 3 ARMS 4"

4"
101,60mm
MAX: Ø 170mm
MIN: Ø 55mm



REF.	DESCRIPTION					€
11878	SET OF 2 POLISH PAD 1-1/8" FOR REF. 52591	0.10	25	100	-	4,10€
11879	SET OF 3 POLISH PAD 2" FOR REF. 52592	0.04	25	100	-	5,10€
11880	SET OF 3 POLISH PAD 4" FOR REF. 52593	0.09	25	100	-	10,50€

53662 **89,00€**

1.78 5 10 80

COMBUSTION GAS LEAK DETECTOR SET



IT CONTAINS
200ml round bottle.
250ml square bottle.
ADAPTERS
Small: Suzuki, Toyota, Mitsubishi.
Medium: Suzuki, Toyota, Mitsubishi, Subaru, Peugeot, Nissan, Lexus, Mazda.
Big: Ford, GM, Benz, JEEP.

REF.	DESCRIPTION					€
14563	COMBUSTION LEAK TESTER FLUID	0.23	5	50	-	18,00€

54347 **46,00€**

2.00 - 5 100

CYLINDER LEAKAGE TESTER

7 BAR **100 PSI**

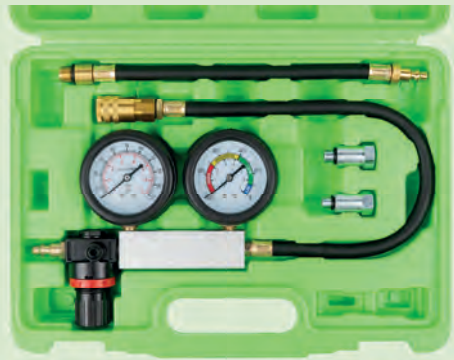

It is used to check the leaks of a cylinder.

M12x1.25
M14x1.2

52832 75,00€

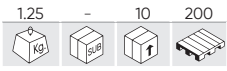

V-BELT TIMING BELT WRENCH SET 12-POINT INTERCHANGEABLE HEAD

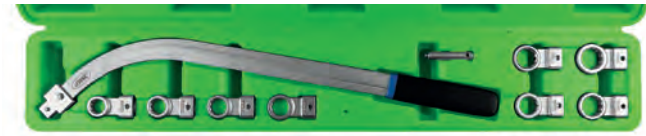

INTERCHANGEABLE HEAD

x8		12, 13, 14, 15, 16, 17, 18, 19mm	x1	
x1				

52690 54,00€

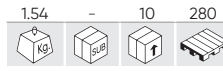

SERPENTINE BELT TOOL SET

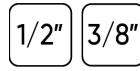

	x4	3/8" - 13, 15, 16, 18mm		x1	1/2" - 230mm
	x3	3/8" - 13, 14, 15mm		x1	3/8" - 585mm

53669 45,00€

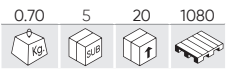

10 PIECES 1/2" SPECIALIST AUTOMOTIVE IMPACT SOCKET SET



	10S	Toyota idler gear center fixings
	6S	Nissan and Renault clutches, cylinder heads and balance shaft fixings.
	8S	Nissan and Renault clutches, cylinder heads and balance shaft fixings.
	12S	Nissan and Renault clutches, cylinder heads and balance shaft fixings.
	8TS	Nissan balance shaft fixings
	14mm	Smart car, Astra G and Zafira brake calliper mounting plate fixings
	10mm	Nissan brake and fuel pump fixings
	12,5mm	Nissan brake and fuel pump fixings
	19mm	Peugeot, Renault and Citroen brake calliper mounting plate fixings
	20mm	Honda Civic lower control arm bolts

53053 12,00€

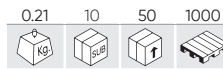

3 PIECES SEAL REMOVING HOOK SET

1x15,5cm/1x16,5cm/1x12cm



53637 85,00€



CYLINDER HEAD COMPONENTS ORGANIZER

- Special for cylinder head.
- Keeps all components neat and tidy as they come off the cylinder head.
- Saves time and frustration.



52850 7,80€



2 PIECE VALVE GRINDER SET

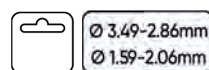

SPECIAL TOOLS

51989

49,00€



38 PCS WIRE / PLASTIC BRUSH SET

38
PCS

Ø 8, 9, 10, 11, 12, 13, 14, 15, 16, 17, 18, 19mm



- 1 1/4" handle.
- 1 extender.
- 36 brushes.

52760

4,10€

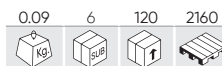

WIRE SCRATCH BRUSH



52515

9,10€

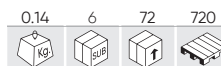

3 PIECE BRAKE CALIPER BRUSH SET

- 1 x Brass.
- 1 x Nylon.
- 1 x Steel.



52819

22,00€

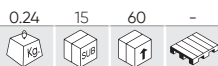

1/2" SPINDLE NUT SOCKET FOR MERCEDES

58
POINTS



53129

84,00€

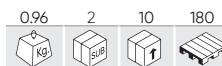

BEARING RACE AND SEAL DRIVER 18-90MM



53875

134,00€



CRANKSHAFT REAR SEAL INSTALLATION TOOL (VAG GROUP)

APPLICATIONS	VW: GOLF, TOURAN AUDI: A3, A4
OEM TOOLS	T10134
ENGINE CODES	1.4I TURBO 1.4 & 1.6 PETROL DIRECT INJECTION 1.9/2.0 SDI 2.0 COMMON RAIL DIESEL ENGINESL

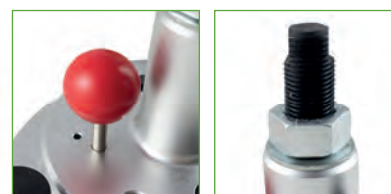

52190

8,00€

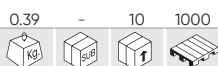

CLUTCH TOOL SPECIALLY FOR FIAT

220x110mm



52495

14,50€

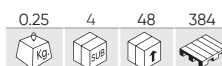

UNIVERSAL PLASTIC CLUTCH ALIGNMENT TOOL

- Aligner tool for most of the vehicles.
- Includes 3 diferents adapteurs of diferent diameters.



53001

242,00€

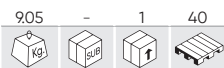

CLUTCH COMPRESSOR MASTER SET

VW, AUDI, BMV, MERCEDES, VOLVO, RENAULT, OPEL

- Clutch deformations are avoided using the pretensioner.
 - Using the Reset Tool, we will bring the reset ring of the pressure plate to the new position when mounting a new clutch valve.
 - Suitable for almost all clutches SAC (Automatic Adjust Clutch).

ADVANTAGE
 Clutch pressure plate tensioning in the assembly and disassembly
 Reposition spring adjustment with reset tool.
 Center of the valve with respect to the guide bearing.

CONTENT
 Clutch Pretensioner.
 3-hole center.
 Reset tool.
 Centering set.
 4 hole center.



53410

92,00€

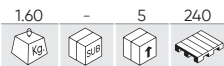

UNIVERSAL CLUTCH ALIGNING SET

CENTERING DIAMETERS

x3 15-19, 20-26,6, 23-36mm

ACCESSORIES DIAMETERS

x8 12, 14, 15, 16, 17, 18, 19, 20mm

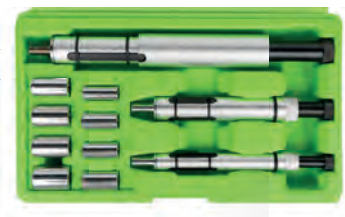

53057

149,00€

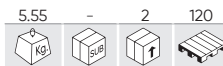

DSG CLUTCH TOOL SET - VAG

- For service in DSG changes in Golf (2004-), Golf Plus (2005-), AUDI A3 (2004-) with 7-speed transmissions code 0AM, and in Touareg (2003-) with 6-speed transmission code 08D).
 - OEM References of Tools: T10323, T10373, T10374.



50731

68,00€



ALCOHOL REFRACTOMETER



52963

49,00€

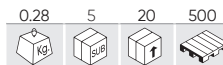

UNIVERSAL REFRACTOMETER

- Ethylene glycol: -50°C ~ -0°C.
 - Propylene glycol: -50°C ~ -0°C.
 - Cleaning fluid: -40°C ~ -0°C.
 - UREA AUS32: - 30% ~ 35%.
 - Battery: - 1.100 - 1.400 sg/l.



UREA AUS32

53477

36,10€

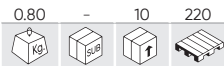

8 PCS HOSE LOCKING PLIERS SET

8 PCS
 NYLON

8mm
 10mm
 13mm



53426

39,80€

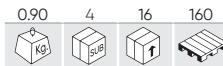

VACUUM AND FUEL PUMP TESTER

PRESIÓN PRESSURE 0-0,7Kg/cm² (0-10 PSIG)
 VACÍO VACUUM 0-28 inHg (0-70 cmHg)



SPECIAL TOOLS

52066

12,00€

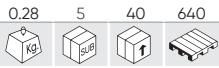

3 PIECE HOSE CLAMP SET



0-20mm
0-35mm
0-70mm

53395

16,00€

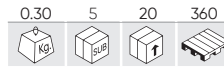

3 PIECE FLEXIBLE HOSE CLAMP SET ANGLED JAWS



Ø13mm
Ø20mm
Ø35mm

52687

168,00€

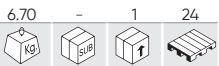

COOLING SYSTEM PRESSURE LEAKAGE TESTER KIT



- 1 Pressure pump with discharge valve
- 2A Connector 1: Coupling for No.3(R123) and No.4 (R124)
- 2B Connector 2: Coupling for No. 3(R123) and No. 5(R125)
- 3 Mercedes (W123, W126, W124, W201), GM(Buick), Jeep
- 4 Peugeot, Subaru, Chrysler, Acura, GM (Nova, Spectrum, Sprint), Mitsubishi, Nissan, Mazda, Toyota, Infiniti, GEO, Suzuki, Isuzu, Mercedes
- 5 Honda, Toyota, Suzuki, Mitsubishi, Chrysler, Acura
- 6 Mercedes Benz (ML, W163, W164), GM (Acliva, Skylark, Grand Am 1992~2002)
- 7 Volvo, Saab, Sterling, Citroën, Renault, Fiat, Alfa, Jeep
- 8 VW(Vento, T4, Passat-1996, Golf, Beetle, Sharan)
- 9 Audi(A4, A5, A6), BMW 345, VW (Passat - 1997-2002), Porsche(Cayenne)
- 10 BMW (E46, E36, E34, E39, E38, E32, E90)
- 11 Audi, VW
- 12 Internacional, Land Rover, Jaguar
- 13 Mercedes (C, E, S, W140, W220, W124, W210, W211, W215, W216, W221, R230)
- 14 Ford Focus
- 15 Mazda(M3)
- 16 Mercedes clase A (W168)
- 17 BMW E60, E63, E64, E65
- 18 VW SHARAN 1.8T 2.8
- 19 TOYOTA-RAV4, PREVIA Universal rubber adapter for drain and fill radiators



- 20 SAAB
- 21 LAND ROVER
- 22 Kia
- 23 Hunday

54139

147,00€

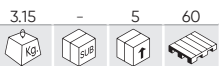

COOLING SYSTEM UNIVERSAL PRESSURE LEAKAGE TESTER KIT (5 PCS)



x1 17-24mm
x1 28-31.5mm
x1 37-39.5mm
x1 47-48.5mm



53453

7,00€

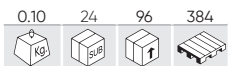

BATTERY FLUID TESTER - DIAL TYPE

-43°C
131°C



54368

2.329,00€

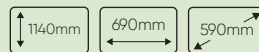
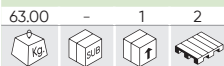

COOLING SYSTEM CLEANING MACHINE

This machine allows you to clean and refill the entire cooling system of the vehicle in a quick and efficient way. By generating pressure, it pumps the coolant throughout the system and cleans it of various deposits. It is compatible with different types of coolants.

The machine is connected to the vehicle's battery at 12V, and has an intuitive interface which, together with its touch screen, two pressure gauges and two displays to observe the state of the fluid, makes it very easy to use. Quick connectors, tubing and adapters are available for easy fitting to the vast majority of vehicles. It contains two 20-litre tanks, one for new coolant and the other for used coolant, both of which are emptied through the machine itself. In circuits with the presence of rust or oil, the use of additives is recommended for greater cleaning power.

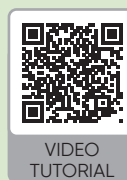

53539

66,00€



A/C LEAK DETECTION KIT

CONTAINS

- 1 x UV Lamp.
- 1 x UV vision goggles.
- 1x Batteries rechargeable.
- 1 x Syringe fluid insertion.
- 1 x Quick Adapter.
- 1 x Extension adapter.
- 1 x Charger.



REF. DESCRIPTION

REF.	DESCRIPTION	Box	Carton	Pallet	€
15052	RECHARGEABLE BATTERY FOR REF.53539	0.05	5	10	3,00€
15053	CHARGER FOR REF.53539	0.08	-	10	10,50€
15054	LIGHT FOR REF. 53539	0.12	-	50	34,00€
14187	UV GLASSES (REF.53539)	0.05	10	120	6,00€
12200	AA/CC LEAK DETECTION SYRINGE (REF. 52844)	1.10	-	50	14,50€



SPECIAL TOOLS

54291

5.054,00€

116.00	-	1	1

N

AIR CONDITIONING CHARGING MACHINE

200V
±10% R134A
R1234YF

This machine has been designed to do cleaning, coolant recovery, vacuum, oil injection and refrigerant recharge in the vehicle's air conditioning system. It is fully automatic. Once the parameters for each function have been configured, it will perform all processes without the need for the operator to be attentive at all times.

3/8 HP >2 Kg/min 100 L/min

450g/min 800g/min 12,12 cm³

MAIN CHARACTERISTICS

FULLY AUTOMATIC

EASY TO USE

WITH LARGE INSPECTION WINDOW AND LED BACKLIGHT

PRESSURE GAUGES MAKE IT EASY TO OBSERVE PRESSURE VALUES

HIGH GAS AND OIL RECOVERY RATE

WITH LARGE LCD SCREEN

WITH DATABASE AND PRINTER

SOFTWARE AND DATABASE CAN BE UPDATED

LCD 360x128mm 50-60 Hz -10° 50°

99% <85% 180W



SPARE PARTS AVAILABLE



VIDEO TUTORIAL

16309

149,00€

1.40	-	1	-

N

SET OF 2 HIGH AND LOW PRESSURE HOSES OF 5 METER LONG (REF.54291)



1234YF GAS ADAPTER

R1234YF Quick connect refrigerant air conditioning Adapter. The quick connect design has an integral safety. Sleeve which protects against injury and refrigerant loss if the coupler is disconnected under pressure. Uses: air conditioning and refrigeration.



53499

29,00€

0.20	15	60	2400

1234YF GAS ADAPTER (HIGH)



- Red (high pressure)
- Material: Brass & metal
- Weight: 194g

53500

29,00€

0.20	15	60	2400

1234YF GAS ADAPTER (LOW)



- Blue (low pressure)
- Material: Brass & metal
- Weight: 175g

53456

98,00€

2.90	-	5	75

AIR CONDITIONING DIAGNOSTIC GAUGE SET (BAR)

BAR LOW: 0-24BAR HIGH: 0-34BAR

PSI LOW: 0-350PSI HIGH: 0-500PSI

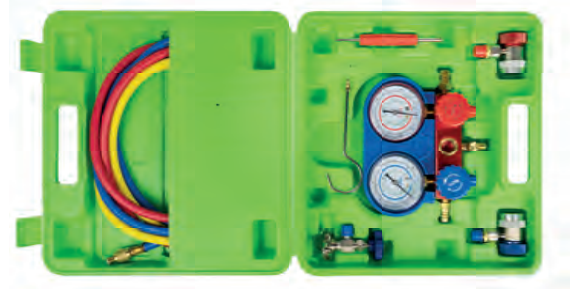

REF. DESCRIPTION

REF.	DESCRIPTION					€
14300	QUICK COUPLER FOR HIGH PRESSURE (REF.53456)	0.15	-	100	-	19,00€
14301	QUICK COUPLER FOR LOW PRESSURE (REF.53456)	0.15	-	100	-	19,00€

16316 18,50€

0.30 - 12 -

UNIVERSAL PAG OIL FOR AIR CONDITIONING SYSTEMS 250ML

N

12977 36,50€

0.33 3 12 480

FLUID DETECTOR LEAKS FOR AIR CONDITIONING SYSTEM. 250 ML

- An application of 7.5 ml for each 1.4 L of coolant.

50807 38,00€

0.16 6 24 744

AIR CONDITIONING RUBBER O-RING ASSORTMENT 270PCS

Ø	PCS	Ø	PCS
5.29x1.78	20	8.80x1.90	20
6.07x1.78	20	10.82x1.78	15
6.8x1.9	20	10.77x2.62	15
7.65x1.78	20	11.0x2.0	15
7.80x1.90	20	12.0x2.0	15
8.0x2.0	20	13.9x1.80	10

Ø	PCS
13.95x2.62	10
14.0x2.0	10
15.0x2.0	10
17.0x2.0	10
17.17x1.78	10
17.04x3.53	10

53599 30,30€

0,16 10 100 -

CAR AIR CONDITIONING SCHRADER VALVE CORE SET

SPARE PARTS AVAILABLE

REF	mm	PCS	€
14594	5x19mm R12	50	2,00€
14595	5x19mm	30	1,50€
14596	5x19mm R12	30	2,00€
14597	6x19mm	3	7,60€
14598	6x26mm	1	17,80€
14599	7x20mm R134A	10	4,50€
14600	6x22mm	5	9,50€
14601	8x22mm	1	11,00€
14602	9x22mm	4	11,00€

53459 66,00€

1.05 - 10 150

FUEL AND AIR CONDITIONING HOSE LINE DISCONNECT SET

CLAMPS DIAMETER

x6 8mm (5/16"), 9.5mm (3/8"), 13mm (1/2"), 16mm (5/8"), 19mm (3/4"), 22mm (7/8")

BLOCKER DIAMETER

x4 9.5 mm (3/8"), 16mm (5/8"), 13mm (1/2"), 19mm (3/4")

51364 26,00€

2.00 - 5 315

HOMOKINETIC JOINT PULLER

Ø 31mm 140-240mm

54069 29,50€

0.20 10 40 360

14PCS STUD HUB CLEANER KIT

x1 1/2" Sq 8mm socket driver adaptor

x1 Grinding wheel with round drive shaft hex 8mm

x2 Replacement hook and loop pads with self-adhesive back

x5 Coarse-grained cleaning discs, outer diameter 40 mm.

x5 Fine-grained cleaning discs, outer diameter 40 mm, inner diameter 14mm

51364 26,00€

2.00 - 5 315

HOMOKINETIC JOINT PULLER

Ø 31mm 140-240mm

SPECIAL TOOLS

53638

243,00€

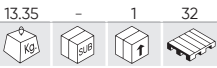

HYDRAULIC WHEEL HUB PULLER

- This set includes 3 pullers / hammers:
 - Hydraulic spindle
 - Screw
 - Impact hammer specially
- They are designed to simplify the removal of the wheel hub and release the drive shaft without any damage.
- For manual or hydraulic extraction.
 - Hydraulic spindle with 10 ton maximum capacity.
 - 4kg hammer.
 - Bar length: 57cm.
 - Suitable for: 3, 4, 5 and 6 holed hubs.

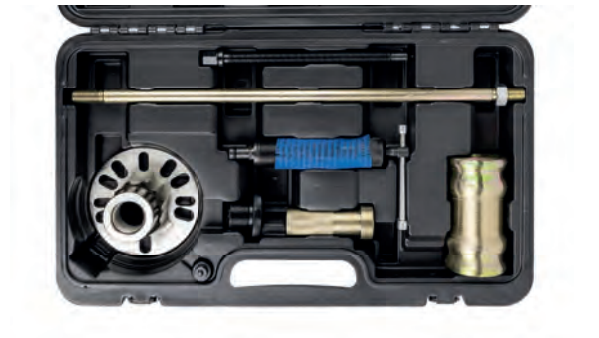

REF. DESCRIPTION

1.35 1 10 62,00€

15253 HYDRAULIC SPINDLE FOR REF. 53384/53638

54384

32,50€

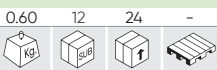

WHEEL HUB CLEANER

It helps you clean the oxide and corrosion found on the wheel hub. It has a Velcro strip to install the abrasive disk easily.

External diameter: 150mm
Internal diameter: 90mm
Maximum speed: 500RPM

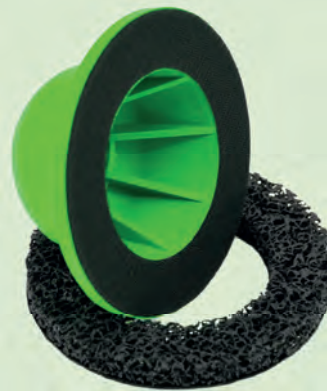

REF. DESCRIPTION

0.11 16 64 16,50€

16448 WHEEL HUB CLEANING DISK (REF.54384)

52829

19,00€

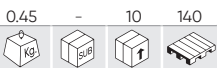

CV BOOT TOOL

EXTERIOR

Ø 10cm

INSIDE

Ø 9,5cm

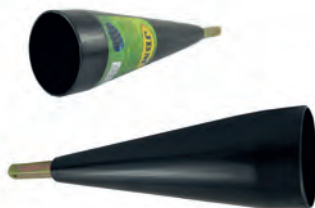

52541

45,00€

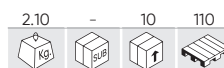

SUSPENSION WEAR INDICATOR



- Application range:
Dome bearings, silent bearings, carrier joint, track rod end, coupling rod, wheel bearings, axial joint, steering gear, stabilizer, etc.



51121

27,30€



COIL SPRING COMPRESSOR SET

- Claws and stud forged with iron-carbon alloy, both heat-treated to ensure you a professional work.
- Tool designed to be used in limited spaces and under the wheel arch, offering the greatest protection.
- Maximum opening 250 mm.

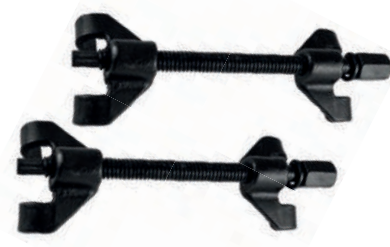

270mm

50827 **387,00€**

32.90 - 1 15

 830mm 350mm 190mm

SPRING COMPRESSOR FOR DAMPENERS



- Max load: 1T (2200 lbs)
- Compressed spring diameter: 200mm
- Compression length: 200-500mm

53742 **1.325,00€**

66.50 - 1 6

 1410mm 690mm 560mm **N**

SPRING COMPRESSOR FOR DAMPENERS 1T



- Capacity: 1000kg
- Max working length: 450mm
- Cylinder stroke length: 420mm
- Spring diameter: Ø102-165mm
- Spinning direction: Clockwise
- Operation: Pneumatic
- Air pressure: 6.5 - 9 bar (94.27-130.53 psi / 0.65-0.9 MPa)
- Functioning mode: Foot pedal

53394 **598,00€**

29.70 - 1 18

COIL SPRING COMPRESSOR SET

- Telescopic arm and non-slip surfaces that allow a solid grip of the springs.
- Claws equipped with an interchangeable plastic protection to avoid damaging the painting.
- It prevents the springs from bending in compression.
- Universal, covers 90% of the vehicle fleet.

CONTENT
 Device / piston.
 Three pairs of jaws with plastic covers.



SUITABLE FOR USE WITH PNEUMATIC TOOLS

52227 **247,00€**

15.10 - 1 40

MACPHERSON STRUTS COIL SPRING COMPRESSOR

- Technic specifications:
 Maximum Charge: 2500N.
 Principal part.
 Extended support.
 3 jaw pairs.
- 1st PAIR: USE RANGE: 80-115mm. WEIGHT: 1.45 Kg.
- 2nd PAIR: USE RANGE: 110-195mm. WEIGHT: 2.2 Kg.
- 3th PAIR: USE RANGE: 140-195mm. WEIGHT: 2.3Kg.

BMW, TOYOTA, FORD, MITSUBISHI, VW, AUDI, SAAB, NISSAN, HONDA ACCORD, SUBARU, VOLVO, OPEL, PORSCHE.

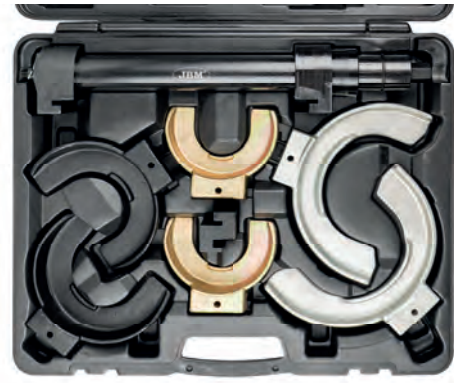

DO NOT USE WITH AIR IMPACT WRENCH

SPECIAL TOOLS

52270

109,00€

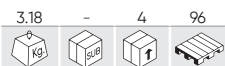

SILENT BLOCK PULLER VAG

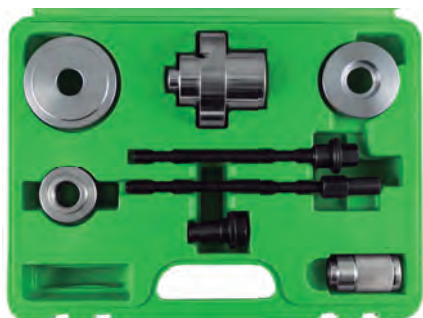

Mounting adaptor for mechanic spindle, shoulder nut, spindle extension

Spacer

Press piece

Press piece insertion

Centering ring

52432

35,00€



SUSPENSION BUSH TOOL SET VAG



- Special for VW Polo 2002.

EXTRACTOR

REF.	DESCRIPTION	MAX	MIN				€	
51368	UNIVERSAL INNER TIE ROD WRENCH	42mm	33mm	0.41	5	50	2700	19,00€
51369	UNIVERSAL INNER TIE ROD TOOL	42mm	35mm	0.55	6	36	756	28,00€
51414	STUD HEAVY DUTY EXTRACTOR	20mm	15mm	0.59	5	40	1440	14,00€



51368



51369



51414

52834

195,00€



BALL JOINT SOCKET SET (AUTER TYPE)

11 PCS 1/2" Cr-Mo

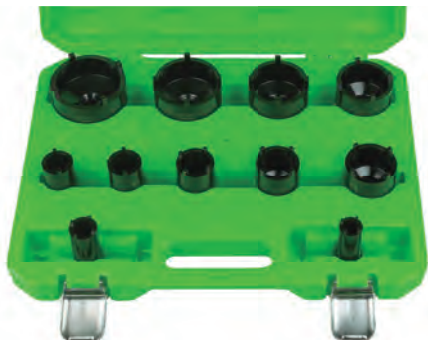

x11 22x3.3mm, 26x3.8mm, 30x4.3mm, 33x4.0mm, 37x4.8mm, 44x5.3mm, 50x5.8mm, 56x5.8mm, 63x6.3mm, 69x6.8mm, 75x6.8mm

52835

272,00€



BALL JOINT SOCKET SET (INNER TYPE)

10 PCS 1/2"



x10 26x5.3mm, 1,2x6.25mm, 34.2x6.3mm, 38.2x6.65mm, 42.2x7.3mm, 50.1x8.25mm, 58.2x9.8mm, 74.6x11.9mm, 82.2x13.25mm, 87.7x13mm

RACK END REMOVER AND INSTALLER

REF.	DESCRIPTION					€
52640	Ø 28-35mm	1.80	-	4	256	52,00€
52641	Ø 35-45mm	2.20	-	4	140	55,00€



TRACK ROD ADJUSTING WRENCH

REF.	DESCRIPTION					€
52874	Ø 9-20mm	1.20	4	20	1500	82,00€
52875	Ø 14-23mm	1.25	5	20	1500	79,00€



53635

6.50	-	2	80

WHEEL BEARING PULLER WITH SLIDING HAMMER

- Sliding hub: 4 KG.
- Diameter range: 100-115mm.
- For M12 screws.



85,00€

440-630mm

51490

36,00€

1.88	-	5	360

5 PIECES FORK TYPE BALL JOINT SPLITTER SET



HANDLE FOR USE WITH A HAMMER
YOKES: 11/16, 15/16 AND 1-1/8"

53384

165,00€

7.30	-	2	62

HYDRAULIC BALL JOINT SEPARATOR

- Overture: 100mm.
- Width: 35mm.



REF.	DESCRIPTION				€
15253	HYDRAULIC SPINDLE FOR REF. 53384/53638	1.35	1	10	62,00€

53208

126,00€

0.95	5	20	-

WHEEL LOCK SCREW SOCKET SET FOR BMW

22 PCS BMW 41-60



APPLICATIONS

BMW Serie 1 F20/F21
BMW Serie 3 F30/F31
BMW Serie 4 F32/F34/F36

BMW Serie 5 F10/F11
BMW Serie 6 F12/F13
BMW Serie 7 F01/F02/F04

x20 41, 42, 43, 44, 45, 46, 47, 48, 49, 50, 51, 52, 53, 54, 55, 56, 57, 58, 59, 60

53207

118,00€

1.55	5	10	330

WHEEL LOCK SCREW SOCKET SET FOR VW

23 PCS VW



x1 B51 / 6PT			
x1 B52 / 7PT			
x1 B53 / 8PT			
x1 B54 / 9PT			
x1 B55 / 10PT			
x1 B56 / 11PT			
x1 B57 / 12PT			
x1 B58 / 13PT			
x1 B59 / 14PT			
x1 B60 / 15PT			
x1 B61 / 16PT			
x1 B62 / 17PT	x1 ABC3 / 14PT		
	x1 ABC4 / 15PT	x1 ABC7 / 19PT	
	x1 ABC1 / 11PT	x1 ABC8 / 20PT	
	x1 ABC2 / 13PT	x1 ABC9 / 21PT	

SPECIAL TOOLS

52802

54,00€

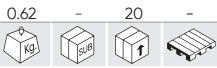

WHEEL LOCK SCREW SOCKET SET FOR BMW

10 PCS BMW



x1	30/13 PT
x1	31/15 PT
x1	32/16 PT
x1	33/17 PT
x1	34/18 PT

x1	35/19 PT
x1	36/20 PT
x1	37/21 PT
x1	38/22 PT
x1	40/23 PT

53328

76,00€



WHEEL LOCK SCREW SOCKET SET FOR MERCEDES

12 PCS

MERCEDES



APPLICATIONS

A, B, C, GLK, CLC, CLS, CLK, E, SL, SLK, M, C300, C250, C350, E320, 204, 211, 212, R

51998

38,00€

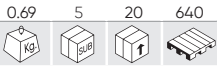

TWIST SOCKET SET WHELL LOCK NUT REMOVER 3/8"

10 PCS 3/8" Cr-Mo

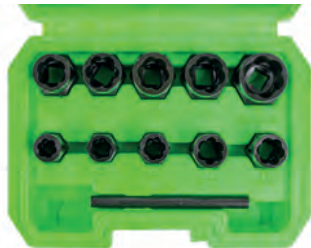

SPARE PARTS AVAILABLE

REF.	mm	Kg	Pcs	Tray	€
16737	9mm	0.07	-	100	12,00€
11434	10mm	0.04	-	100	12,00€
11435	11mm	0.04	-	100	12,00€
11436	12mm	0.04	-	100	12,00€
11437	13mm	0.04	-	100	12,00€

REF.	mm	Kg	Pcs	Tray	€
11438	14mm	0.06	-	100	12,00€
11439	15mm	0.06	-	100	12,00€
11440	16mm	0.06	-	100	12,00€
11441	17mm	0.08	-	100	12,00€
11442	19mm	0.09	-	100	12,00€

52962

42,00€

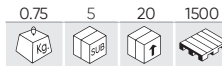

SET OF 3/8" TWIST SOCKETS FOR REMOVAL OF SAFETY SCREW/NUTS 6-19MM

11 PCS 3/8" Cr-Mo



SPARE PARTS AVAILABLE

REF.	mm	Kg	Pcs	Tray	€
11450	6mm	0.07	-	100	12,00€
12093	8mm	0.07	-	100	12,00€
11434	10mm	0.04	-	100	12,00€
11435	11mm	0.04	-	100	12,00€
11436	12mm	0.04	-	100	12,00€
11437	13mm	0.04	-	100	12,00€

REF.	mm	Kg	Pcs	Tray	€
11438	14mm	0.06	-	100	12,00€
11439	15mm	0.06	-	100	12,00€
11440	16mm	0.06	-	100	12,00€
11441	17mm	0.08	-	100	12,00€
11442	19mm	0.09	-	100	12,00€

52823

124,00€

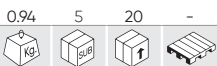

WHEEL LOCK SCREW SOCKET SET FOR AUDI

22 PCS VAG

A, B, C, E, F, G, H, I, J, L, M, N, P, Q, R, S, T, V, W, X



x20 A, B, C, E, F, G, H, I, J, L, M, N, P, Q, R, S, T, V, W, X

54317

124,00€



WHEEL LOCK SCREW SOCKET SET FOR VAG

22 PCS VAG CR-MO

521,522,523,524, 525,526,527,528, 529,530,531,532, 533,534,535,536, 537,538,539,540



x20 521,522,523,524,525,526,527,528,529,530,531,532,533,534,535,536,537,538,539,540

52153

46,00€

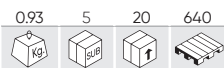

TWIST SOCKET WHEEL LOCK NUT REMOVER SET 1/2"

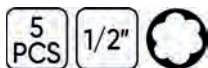

SPARE PARTS AVAILABLE

REF.	mm				€	REF.	mm				€
11443	17mm	0.02	25	100	14,00€	11446	23mm	0.03	25	100	15,00€
11444	19mm	0.02	25	100	14,00€	11447	27mm	0.03	25	100	15,50€
11445	21mm	0.02	25	100	15,00€						



54253

166,00€



MASTER LOCKING WHEEL NUT REMOVER SET

Simple to use master kit capable of removing Practically any locking wheel nuts. Kit includes shrouds, which protects the wheel against any damage. Very effective and a must have workshop tool. The kit contains two sizes of impact cutting blades to fit most common locking wheel nuts by cutting into the outer rim. Also included are three double sided blades for moulding in to the socket shape directly

UNIVERSAL: Removes a wide range of sizes, type and profiles including those with spinning collars Includes impact driver and punch.

SPARE PARTS AVAILABLE

REF.	DESCRIPTION				€
16300	CUTTER A AND CHUCK	0.15	-	100	7,60€
16301	CUTTER B AND CHUCK	0.15	-	100	7,60€
16302	CUTTER C (REF. 54253)	0.05	-	100	7,60€

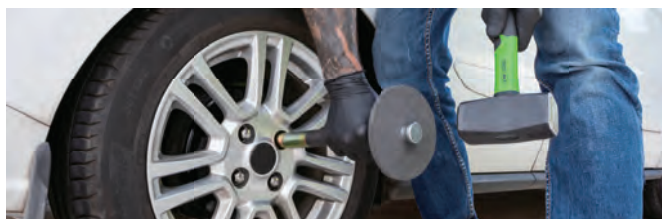

54299

227,00€



WHEEL HUB AND BEARING MASTER KIT



	5,3cm		8,6x10,9cm
	5,8cm	B	8,2x10cm
	6,5cm		7,1x9,45cm
	6,6cm		8,9x17,6cm
A	∅ 2,3mm	C	9,9x17,6cm
	7,1cm		12x17,8cm
	7,3cm	D	∅ 2,3mm 9,5cm
	7,8cm	E	∅ 8,6mm 9,55cm
	8,3cm	F	2,4x28cm

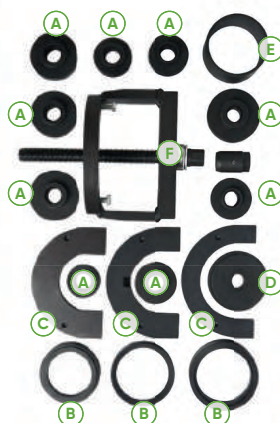

SPECIAL TOOLS

51919

89,00€



TORQUE MULTIPLIER WITH EXTENDER

4
PCS



- Material: 40 CR.
- Maximum power: 5800 Nm.
- Work power: 3800Nm.
- Multiple in range 1: 56.
- Includes 32mm and 33mm 1" sockets.

52796

98,00€

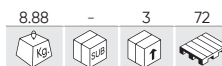

TRUCK TORQUE MULTIPLIER SET

5
PCS 6000
Nm



- Prevents rim damage.
- Easy adaptation to any universal vehicle.
- Useful for effortless screwing and unscrewing.

CONTENTS

- 1x socket 1" 32mm.
- 1x socket 1" 33 mm.

51958

422,00€



TORQUE MULTIPLIER SET 3/4" (F) + 1/2" (M)

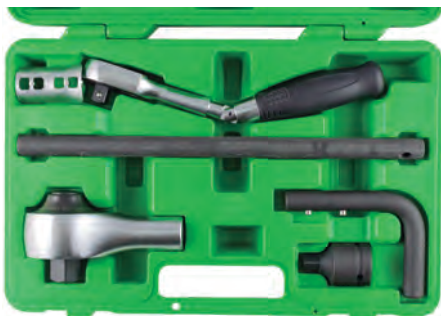

CONTENTS

- 1x torque multiplier.
- 1x manual ratchet.
- 1x 1/2"M x 3/4"F adapter.
- 1x release kit.
- 1x 90° extension bar.
- 1x 350 mm extension bar.

CHARACTERISTICS

- Transmission ratio 1: 4.
- Torque ratio: 1: 3.3.
- Maximum input torque: 303 Nm.
- Maximum output torque: 1000 Nm.

52012

68,00€



CAR TORQUE MULTIPLIER SET

1/2"

PRIVATE CAR



CONTENTS

- 1x torque multiplier.
- 1x 90° extender bar.
- Sockets 17 mm, 19 mm and 21 mm.

- Multiple range: 1: 18.
- Maximum output torque: 360Nm.
- Maximum tightening torque: 800Nm.

EXTRACTOR

REF.	DESCRIPTION	mm	Max.	Min.					€
52642	SCISSOR TYPE BALL JOINT SEPARATOR	17-22mm	60mm	20mm	1.32	5	10	660	32,00€
52699	SCISSOR TYPE BALL JOINT SEPARATOR	18-22mm	50mm	15mm	0.80	5	30	1140	22,00€



52642



52699

51123 91,00€

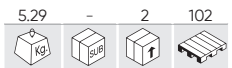

5 PCS BALL JOINT SEPARATOR SET



- Set of versatile pullers.
- This system allows easy removal of the most popular types of ball socket and other joints.
- The type of joint press separator allows removal of the ball socket joint without damage to the loaders and other pieces that can be caused by other types of pullers.

53488 61,00€

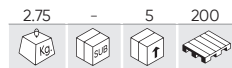

CAMBER ALIGNMENT TOOLS (VAG)



x1	75mm	Seat - Toledo VW - Jeta / Golf
x1	85mm	Seat - Cordoba VW - Polo / 95>
x1	115mm	Chrysler - Voyager
x1	22mm	

51902 84,00€

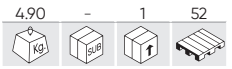

SUSPENSION ARM LEVER

- Measurements:
- Length: 118cm.
- Ø Diameter Tube: 3.5 cm.
- Brace distance: 50, 45, 40, 35, 30 cm.
- Fastening support: 15 x 13 cm.



REF.	DESCRIPTION	KG	SUB	QTY	€
10953	FASTENING SUPPORT REPLACEMENT FOR REF.51902	0.83	-	25	12,50€

51119 62,00€

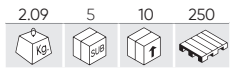

7 PCS O2 SENSOR SOCKET SET

7 PCS 1/2" 3/8"

x1	1/2"	29x9 ~ 90mm
x1	1/2" ~ 7/8"	50mm
x1	1/2"	27x12 ~ 78mm
x1	3/8" ~ 7/8"	6 ~ 90mm
x1	3/8" ~ 7/8"	6 ~ 80mm
x1	3/8" ~ 7/8"	30mm
x1	3/8" ~ 1"	74mm
x1	1" ~ 1/16"	74mm



52637 48,00€

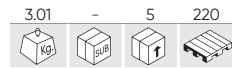

MUFFLER TAIL AND EXHAUST PIPE EXPANDER SET

x1	1-1/8" - 1-3/4"
x1	1-1/2" - 2-1/2"
x1	2-1/8" - 3-1/2"



SPECIAL TOOLS

51491

154,00€

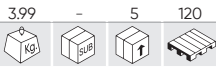

LAMBDA SOCKET SET 14 PC

14 PCS

17x78mm	12PT	Renault
19x78mm	12PT	VW, Polo, Audi, Seat, Mazda
20x78mm	6PT	Deschis, Japon
27x78mm	6PT	Deschis, Japon
21x90mm	12PT	Seat, Audi, VW, Skoda, Alfa Romeo, Mitsubishi
22x78mm	12PT	Seat, Audi, VW, Skoda, Opel
22x110mm	12PT	Mercedes, Citroën, Peugeot, Ford, Nissan, Mazda, Mitsubishi, Seat, Audi, VW...



51991

54,00€

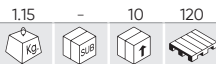

WHEEL ALIGNMENT TOOL

- Total open length: 1950 mm.
- Total closed length: 1100 mm.
- Screw measurement: M6 x 15mm.
- 20 x 20 aluminium exterior tube.
- 16 x 16 zinc plated iron interior tube.



53118

231,00€

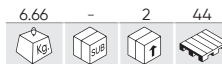

39 PIECE SHOCK ABSORBER TOOL SET

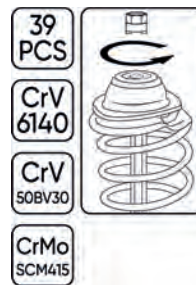

52822

32,00€

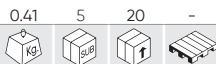

OXYGEN SENSOR WRENCH 22MM



ARTICULATED HEAD

52849

8,50€

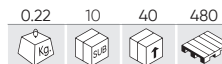

2 PCS EXHAUST RUBBER HOOK SET



52852

6,80€

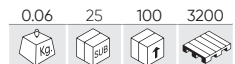

2PCS PICK AND HOOK SET



51347

9,90€

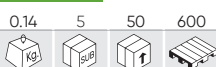

TECHNICIAN'S STETHOSCOPE

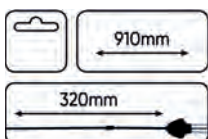

- Locates and amplifies internal mechanical and fluid passage noises.
- Locates the source of engine noise rapidly.
- Listens to problems of rational localization of water, petroleum, gas or vapour flows.
- Shockproof handle



53249

192,00€

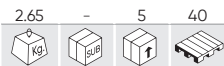

AUTOMOTIVE ELECTRONIC STETHOSCOPE

Kit suitable for detection faults in intake/exhaust manifolds, injectors, radiators, etc. Allows the simultaneously auscultation of several points of the vehicle facilitating the task of the operator to find and diagnose faults. Probes marked by color to facilitate the task of the operator.

FEATURES

- Sensor cable length: 4.8 M
- Audio probe length: 14 cm
- 9v batteries (included)
- Number of sensors: 6
- Suitable for 3.5 Mm connector
- Microphone adjustable length: 21cm

x1	Audio probe	x6	Six-channel microphone selector box
x1	Headphones,	x1	Velcro fastening for sensors
x6	Clip-on microphones	x1	9v batteries



52293

98,00€

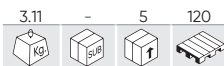

30 PIECES ALTERNATOR PULLEY TOOL KIT

A	x1	H38x3 Pins - 20mmL
B	x1	H17x4 Pins - 30mmL
C	x1	3/8" Dr. x H10
D	x1	1/2" Dr. x H10
E	x9	M10xH12 (64mmL), T50xH12 (64mmL), H10xFH10 (68mmL), H8xH10 (75mmL), M8xH10 (75mmL), M10xH10 (75mmL), H10xH10 (75mmL), T40xH10 (75mmL), T50xH19 (75mmL)
F	x3	1/2" Dr. T50 - 17mm x T33 - 100mmL, 1/2" Dr. M10 - 17mm x T33 - 100mmL, 3/8" Dr. M10 - 12mm x T31 - 85mmL,
G	x4	1/2" Dr. T50 - 140mmL, 1/2" Dr. M10 - 140mmL, 1/2" Dr. T50 - 200mmL, 1/2" Dr. M10 - 200mmL
H	x5	H17xH21 (30mmL), H15xH28 (30mmL), H19xH28 (30mmL), H21xH28 (30mmL), H22xH28 (30mmL)
I	x2	H22 (30mmL), H17 (35mmL)
J	x3	H22x22mm x T33 (300mmL), H15x15mm x T33 (30mmL), 15mm x T33 (30mmL)

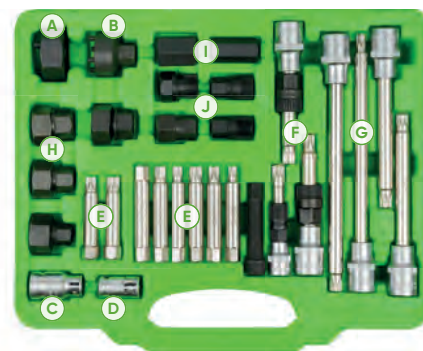

51259

58,00€

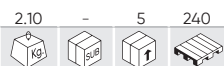

18 PIECES ALTERNATOR PULLEY TOOL KIT

SPARE PARTS AVAILABLE

REF.	DESCRIPTION	kg	5	100	€
10485	M10 XZN BIT SOCKET FOR 51259	0.10	5	100	8,10€
10486	T50 BIT SOCKET FOR 51259	0.15	5	50	8,00€
10494	14CM EXTENSION BIT FOR 51259	0.16	-	-	6,50€
10495	H10 BIT FOR 51259	0.06	-	-	3,00€
10496	H8 BIT FOR 51259	0.06	5	50	3,00€
10497	H10 BIT FOR 51259	0.06	5	100	3,00€
10498	M8 BIT FOR 51259	0.06	5	50	3,00€
10499	T40 BIT FOR 51259	0.05	5	60	3,00€
10500	T50 BIT FOR 51259	0.06	5	100	3,00€
10501	3/8" M10 BIT SOCKET FOR 51259	0.08	5	100	8,10€
10502	M10 75MML BIT FOR 51259	0.06	-	20	3,50€

IT CONTAINS

A	x3	T50x110mm (1/2"), M10x110 (1/2"), M10x90mm (3/8")	E	x1	1/2"x10mm
B	x1	M10x140mm	F	x1	M10x65mm
C	x2	19, 22mm	G	x6	T40, T50, M8, M10, H8, H10 (10x75mm)
D	x3	22x28, 19x28, 21x28mm	H	x1	H22

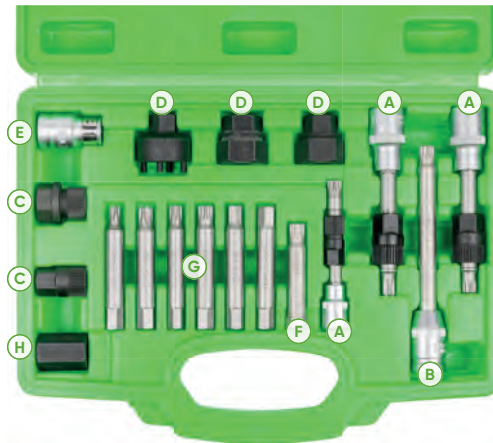

SPECIAL TOOLS

51495

59,00€

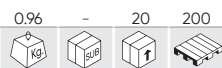

IGNITION COIL PULLER SET FOR VW



- For damage free removal of ignition coils.
 - Fits VW ENGINES CYL 8 & 12 and for 5 & 6 CYL for Golf, Bora in 4 & 5 CYL. - Also for PASSAT with 6CYL Sharan, Touareg and Phaeton too.
 To removaill ignition coils with power unit like VW Polo, Golf 1.4, 1.6i, 1.4i, Caddy, Bora 1.4, 1.6 and Phaeton, Passat Touran 1.6i and Transporter T4.



GLOW-PLUG CONNECTOR PLIERS

REF.	DESCRIPTION				€
52816	GLOW-PLUG CONNECTOR PLIERS ANGLED - 235MM	0.27	6	36	28,10€
52817	GLOW-PLUG CONNECTOR PLIERS STRAIGHT 250MM	0.28	6	36	23,50€



52621

11,00€

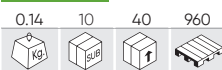

BATTERY TERMINAL CLEANER



52319

8,80€



BATTERY TERMINAL CLEANING TOOL



MAGNETIC SPARK PLUG SOCKET

REF.	"	mm					€
52316	3/8"	250mm - Ø14mm	0.20	12	48	2880	18,90€
52317	3/8"	250mm - Ø16mm	0.30	12	48	2880	19,90€



SPARK PLUG SOCKET

REF.	"	mm					€
10054	1/2"	16mm	0.08	10	100	-	2,90€
10055	1/2"	21mm	0.14	10	100	-	3,90€



52691

54,00€



GLOW PLUG SOCKET SET

WITH MECHANICAL HOLDING SYSTEM

3/8"	8mm (82mm)	3/8"	12mm (82mm)
3/8"	9mm (82mm)	3/8"	14mm (82mm)
3/8"	10mm (82mm)	3/8"	16mm (82mm)



ARTICULATED SPARK PLUG SOCKET WRENCH

REF.	DESCRIPTION					€
54381	ARTICULATED SPARK PLUG SOCKET WRENCH 14MM	0.35	10	40	-	5,00€
54382	ARTICULATED SPARK PLUG SOCKET WRENCH 16MM	0.35	10	40	-	5,00€
54383	ARTICULATED SPARK PLUG SOCKET WRENCH 21MM	0.39	10	40	-	5,00€



N

54380

0.00	10	50	-

119,00€

9 PCS T-HANDLE SOCKET WRENCH SET (7-19MM)



N

SPARE PARTS AVAILABLE

REF.	mm				€	REF.	mm				€
16430	7	0.17	10	50	20,50€	16565	14	0.17	10	50	19,50€
16431	8	0.17	10	50	20,50€	16566	19	0.17	10	50	22,50€
16432	10	0.17	10	50	20,50€	<div style="border: 1px solid black; padding: 5px; display: inline-block;"> 9 PCS CrV 7, 8, 10, 11, 13, 14, 15, 17, 19mm </div>					
16433	11	0.17	10	50	20,50€						
16434	13	0.17	10	50	20,50€						
16435	15	0.17	10	50	21,50€						
16436	17	0.17	10	50	21,50€						



51501

0.88	5	20	240

38,00€

12 PIECES AIRBAG REMOVAL SET

12 PCS

- 0.5 PC 1/4" x 87 mm tips (L):
 2x Torx: T25 (for BMW), T30 (for Audi, Opel, Renault, VW).
 2x Torx (tamperproof): T25H (for BMW), T30H (for AUDI, BMW, Mercedes, Opel).
 1x Hex: 5 mm (for AUDI).

- 0.7 PC puller tool:
 1x for driver airbag. 1999-2004 new body style for VW Passat, JETTA, GOLF.
 2x for VW Passat B5, POLO, LUPO; AUDI A4, A6, Skoda Superb.
 2x for VW GOLF 4, New Beetle, SEAT, SKODA FABIA, AB Oktavia BJ.99.
 1x for VW GOLF 4 (BJ, 1998-2004), VW PASSAT BJ.1997 AB, AB BORA BJ.1999.
 1x for U.A VW MODEL: AB PASSAT BJ.2000.

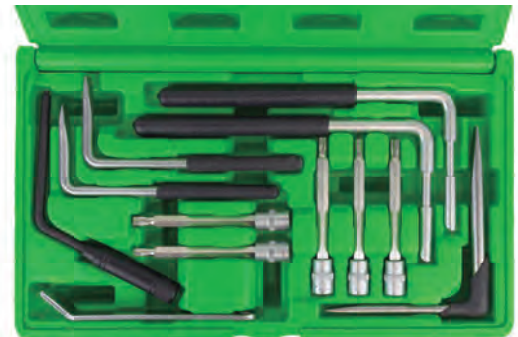

53388

1.50	-	5	120

90,00€

52 PCS RADIO RELEASE TOOL KIT

52 PCS

BLAUPUNKT, CLARION, SKODA, BMW, AUDI, GFUNDIG, JVC, PIONEER, VOLKSWAGEN, MERCEDES, OPEL DOPPEL-KUGEL-INBUS, PORSCHE, BECKER, KENWOOD, SONY, PANASONIC, FIAT BRAVA, FORD.



SPECIAL TOOLS

51126

18,00€

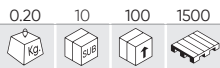

RADIO REMOVAL TOOL SET

**10
PCS**

BLAUPUNKT, PEUGEOT, CLARION, SKODA, ALPINE, BMW, OPEL, AUDI, GFUNDIG VDO, JVC, PIONEER, VOLKSWAGEN, MERCEDES, PORSCHE, RENAULT, BECKER.



53393

118,00€

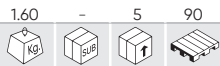

23 PCS TERMINAL TOOL SET

**23
PCS**



BMW, AUDI, VOLKSWAGEN, MERCEDES, OPEL, PORSCHE, JAGUAR, SAAB, SEAT, FORD, SKODA, RENAULT, CITROËN, CHRYSLER, FIAT, HONDA, MAZDA, MITSUBISHI, TOYOTA.

53391

86,00€

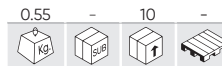

19 PCS TERMINAL TOOL SET

**19
PCS**

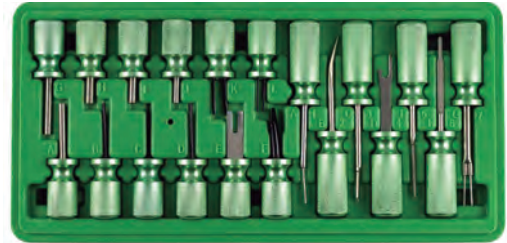

x19 A, B, C, D, E, F, G, H, I, J, K, L, A1, B2, C3, D4, E5, F6, G7

51986

11,90€



200 ML GAS REPLACEMENT

200ml



51920

18,00€

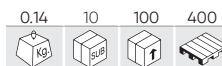

GAS TORCH



53474

94,00€

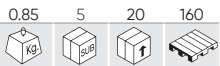

DIGITAL TIMING LIGHT

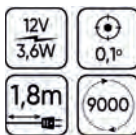

53240

58,00€

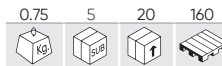

TIMING LIGHT



53663

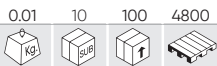

8,00€

CONNECTOR DISASSEMBLY TOOL FOR VAG



- Tool to disassemble connectors in vehicles of the VAG group without damaging them.



THREAD REPAIR SET

53041

37,60€

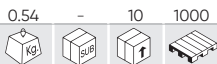

M14 x 1,25

SPECIAL SPARK PLUGS



51898

139,00€

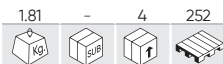

M18 x 2,5



51899

137,00€

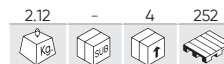

M20 x 2,5



51896

82,00€



115 PIECE THREAD REPAIR SET

115 PCS



CONTENTS

Bit.
Finishing tap.
Helicoil inserter.
Breakage pointer.
Stainless steel spiral set.

MEASUREMENTS

25 x M5x0.8
25 x M6x1
25 x M8x1.25
25 x M10x1.5
10 x M12x1.75

51897

122,00€



39 PIECE THREAD REPAIR KIT

39 PCS



CONTENTS

Bit.
Finishing tap.
Helicoil inserter.
Breakage pointer.
Stainless steel spiral set.

MEASUREMENTS

9 x M12x1.75
9 x M14x2
9 x M16x 2.0

REPLACEMENT HELICOIS

REF.	DESCRIPTION					€
52016	REPLACEMENT HELICOIDS M5X0,8	0.01	10	300	72000	2,10€
52017	REPLACEMENT HELICOIDS M6X1.0	0.01	500	1000	21000	2,40€
52018	REPLACEMENT HELICOIDS M8X1.25	0.01	10	500	21000	2,60€
52019	REPLACEMENT HELICOIDS M10X1.5	0.01	10	500	21000	3,20€
52021	REPLACEMENT HELICOIDS M12X1.75	0.05	100	500	21000	3,40€
52022	REPLACEMENT HELICOIDS M14X2.0	0.03	100	300	12600	4,50€
52023	REPLACEMENT HELICOIDS M16X2.0	0.05	60	300	12600	6,60€
52024	REPLACEMENT HELICOIDS M18X2.5	0.08	-	10	21000	10,60€
52025	REPLACEMENT HELICOIDS M20X2.5	0.10	-	60	21000	13,00€

SPECIAL TOOLS

50793

94,00€

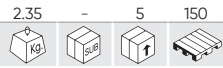

60
PCS

60 PIECE METRIC CASE TAPS AND DIES METRIC AND INCH COMBINED

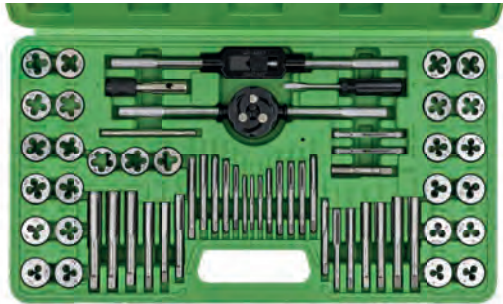

- x1 Male NPT and 1 die stock NPT: 1/8-27.
- x1 Male TPN and 1 die stock TPN: 1/8-27.
- x1 Males Porta mixed type 1: M3-M6 and 3/16" - 1/2"
- x1 Males Porta mixed type 1: M3-M6 and 4-40 6-32
- x1 Joint holder dies: Ø25mm
- x1 Screwdriver
- x1 Metric set of thread gauges
- x1 Metric set of thread inches.
- x10 Males (metrics): M3x0.5, M4x0.7, M5x0.8, M6x1.0, M7x1.0, M8x1.25, M9x1.25, M10x1.0, M10x1.5, M12x1.75.
- x10 Taps UNC (inches): 4-40, 6-32, 8-32, 10-24, 12-24, 1/4-20, 5/16-18, 3/8-16, 7/16-14, 1/2-13.
- x6 Dies UNF (inches): 10-32, 1/4-28, 5/16-24, 3/8-24, 7/16-201/2-20.
- x10 Dies (metric) M3x0.5, M4x0.7, M5x0.8, M6x1, M7x1, M8x1.25, M9x1.25, M10x1, M10x1.5, M12x1.75.
- x10 Males UNC Dies (inches): 4-40, 6-32, 8-32, 10-24, 12-24, 1/4-2, 5/16-18, 3/8-167/16-14, 1/2-13.
- x6 Dies UNF (inches): 10-32, 1/4-28, 5/16-24, 3/8-24, 7/16-20, 1/2-20.

50792

105,00€

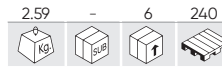

58
PCS

58 PIECE METRIC CASE TAPS AND DIES WITH TITANIUM-COATED



- x1 NPT tap: 1/8-27.
- x1 NPT die: 1/8-27.
- x1 Tap holder: M4-M12.
- x1 T-type tap holder: M3-M6.
- x1 Die holder: 25mm O/D.
- x1 Screwdriver.
- x1 Set of thread gauges.
- x34 Males: M2x0.4 (x2), M3x0.6 (x2), M3x0.5 (x2), M3.5x0.6 (x2), M4x0.75 (x2), M4x0.7 (x2), M5x0.8 (x2), M6x0.75 (x2), M6x1.0 (x2), M7x0.75 (x2), M7x1.0 (x2), M8x1.0 (x2), M8x1.25 (x2), M10x1.25 (x2), M10x1.5 (x2), M12x1.25 (x2), M12x1.75 (x2)
- x17 Screwing dies: M2x0.4, M3x0.6, M3x0.5, M3.5x0.6, M4x0.75, M4x0.7, M5x0.8, M6x0.75, M6x1.0, M7x0.75, M7x1.0, M8x1.0, M8x1.25, M10x1.25, M10x1.5, M12x1.25, M12x1.75

51496

8,00€

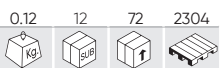

BROKEN TAP EXTRACTOR SET

- N°1 1/8" - 1/4" (M 3-6)
- N°2 1/4" - 5/16" (M 6-8)
- N°3 5/16" - 7/16" (M 8-11)
- N°4 7/16" - 9/16" (M 11-14)
- N°5 9/16" - 3/4" (M 14-18)



53502

38,70€

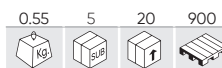

TAP EXTRACTOR KIT

- #2 M5
- #3 M6
- #4 M8
- #5 M10
- #6 M12
- #7 M14
- #8 M16
- #9 M20
- #10 M22



53055

33,00€

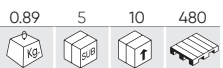

SEPARATING AND RIVETING TOOL FOR MOTORBIKE CHAINS

BREAKING TIPS 2.2mm, 2.9mm, 3.8mm



54280

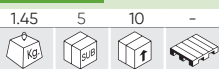

156,50€



SPARK PLUG THREAD REPAIR TOOL SET

SPARE PARTS AVAILABLE

REF.	DESCRIPTION				€
16237	M8X1,0 115MM	0.10	10	40	23,00€
16238	M10X1,0 115MM	0.10	10	40	23,00€
16239	M12X1,25 140MM	0.15	10	40	23,00€
16240	M12X1,25 270MM	0.30	10	40	26,00€
16241	M14X1,25 140MM	0.15	10	40	23,00€
16242	M14X1,25 270MM	0.35	10	40	26,00€
16243	M18X1,5 90MM	0.10	10	40	23,00€

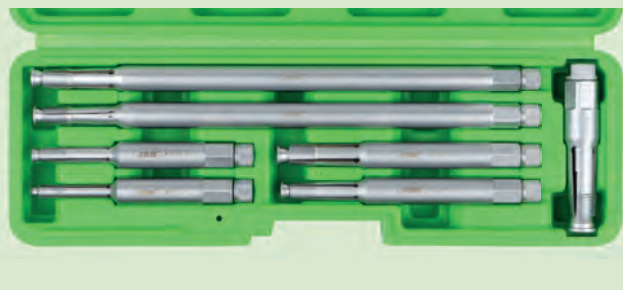

52833

39,30€

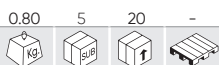

1/2" STUD PULLER SET



SPARE PARTS AVAILABLE

REF.	mm				€
14211	6mm	0.10	20	100	11,00€
14212	8mm	0.10	20	100	12,00€
14213	10mm	0.20	20	100	12,00€
14214	12mm	0.20	20	100	14,00€

53524

51,00€

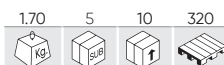

4 PIECES NUT SPLITTER SET



SPARE PARTS AVAILABLE

REF.	mm					€
14049	9-12 mm (1/8" - 1/2")	0.10	-	50	-	8,00€
14050	12-16 mm (1/2" - 5/8")	0.20	-	50	-	10,50€
14051	16-22 mm (5/8" - 7/8")	0.44	25	50	-	18,00€
14052	22-36 mm (7/8" - 1-1/16")	0.65	-	20	-	19,50€

53652

53,00€



WHEEL STUD THREAD RESTORER KIT

SPARE PARTS AVAILABLE

REF.	DESCRIPTION				€
14340	REPAIRING BOLT M12X1.25 - PSA (REF.53652)	0.05	-	20	10,50€
14341	REPAIRING BOLT M12X1.5 - MERCEDES BENZ / BMW (REF.53652)	1.14	-	20	10,50€
14342	REPAIRING BOLT M12X1.75 - VOLVO (REF.53652)	1.12	-	20	10,50€
14343	REPAIRING BOLT M14X1.5 - VAG (REF.53652)	1.29	-	20	10,50€
14344	REPAIRING DISK M12X1.25 (REF.53652)	0.49	-	20	11,00€
14345	REPAIRING DISK M12X1.5 (REF.53652)	0.50	-	20	11,00€
14346	REPAIRING DISK M14X1.5 (REF.53652)	0.46	-	20	11,00€



SPECIAL TOOLS

54003

104,00€

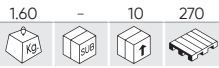

INTERNAL AND EXTERNAL THREAD REPAIR SET



- x1 M14x1.5
- x1 M16x1.5
- x1 M18x1.5
- x1 M20x1.5
- x1 M22x1.5
- x1 M24x1.5
- x1 M27x2.0
- x1 M28x1.5



53665

19,00€

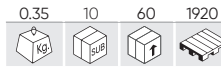

MOTORCYCLE CHAIN CUTTER (25-60)



53666

28,00€

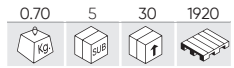

MOTORCYCLE CHAIN CUTTER (60-100)



53054

6,00€

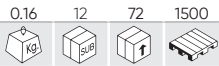

MOTORCYCLE SPECIAL SOCKET



53086

9,00€

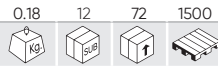

MOTORCYCLE SPECIAL SOCKET



YAMAHA, KAWASAKI,
BMW, SUZUKI, HONDA

52454

12,90€

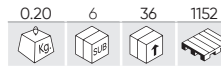

WINDSHIELD WIPER PULLER



53664

38,00€

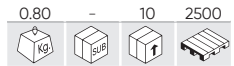

UNIVERSAL PULLEY PULLER



16mm diameter shaft with
centering ball and 24mm
hexagonal screw head.

51125

88,00€

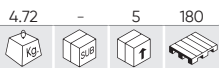

SEPARATOR AND BEAN PULLER SET

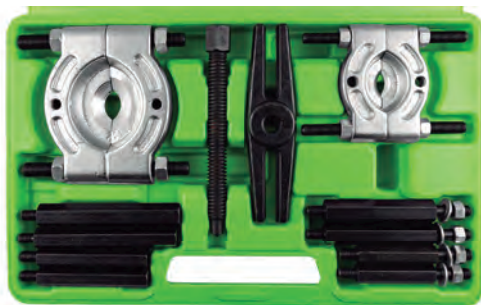

INCH SET:

- x2 1/4", with 30 mm and 50 mm.
- x1 3/8" screw 9.5 x 125 - 24 UNF.
- x1 Head 3/8" x 16 UNC.

2 INCH SET:

- x1 1/4" to 3-1/2", 50 x 75 mm.
- x1 1/2" screw 12.7 x 135 - 20 UNF.
- x1 Head 3/8" x 16 UNC.

BEARING SEPARATOR

REF.	DESCRIPTION	Kg	SUB	€
52626	75-105mm	3.65	- 5	800 46,00€
52627	105-150mm	6.50	- 2	231 120,00€



TWIN LEG PULLERS

REF.	DESCRIPTION	—	I					€
52727	TWO ARMS EXTRACTOR 25-70MM	25-70mm	50mm	0.20	10	60	1200	34,60€
52728	TWO ARMS EXTRACTORS 25-130MM	25-130mm	110mm	1.20	5	10	500	68,00€
52729	TWO ARMS EXTRACTOR 60-200MM	60-200mm	160mm	3.26	-	3	240	128,00€
52730	TWO ARMS EXTRACTORS 80-350MM	80-350mm	225mm	8.55	-	2	108	288,00€

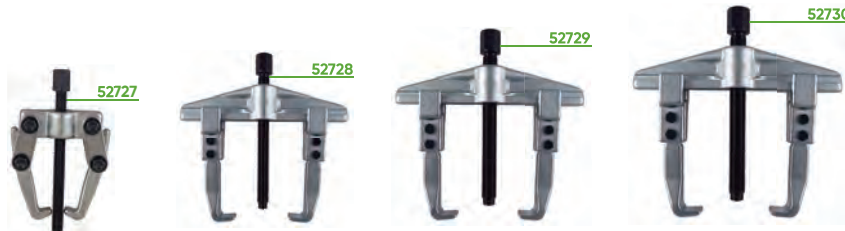

REF.	DESCRIPTION					€
53146	TWO-ARM PULLER DISPLAY	0.70	5	10	140	30,50€

TRIPLE LEG REVERSIBLE PULLER

REF.	DESCRIPTION	—					€
52731	THREE ARMS EXTRACTOR 50-100MM	50-100mm	0.90	4	24	504	38,00€
52732	THREE ARMS EXTRACTOR 70-150MM	70-150mm	2.54	5	20	200	58,00€
52733	THREE ARMS EXTRACTOR 95-200MM	95-200mm	5.20	-	4	112	98,00€



TWIN / TRIPLE LEG BAR TYPE PULLERS

REF.	DESCRIPTION	T					€
52010	TWIN/TRIPLE LEG REVERSIBLE PULLERS 2T	2T	0.50	4	40	360	80,00€
52296	TWIN / TRIPLE LEG REVERSIBLE PULLERS 5T	5T	1.57	4	8	120	119,00€
52297	TWIN / TRIPLE LEG REVERSIBLE PULLERS 7T	7T	3.33	-	6	36	172,00€
52298	TWIN / TRIPLE LEG REVERSIBLE PULLERS, SHORT AND LONG CLAW	2T	2.65	3	6	396	177,00€



SPECIAL TOOLS

53701

188,00€

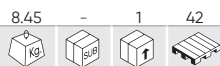

2/3 LEGS UNIVERSAL PULLER SET

- 2-leg extractor range: 45-120mm.
- 3-leg extractor range: 50-130mm.
- Clamping depths: 100, 200, 250mm.

CONTAINS

- Central guide for 3 claws.
- Central guide for 2 claws.
- Stud bolt: 275mm.
- Stud bolt: 165mm.
- Long grip claws: 250mm.
- Medium grip claws: 200mm.
- Short grip claws: 100mm.

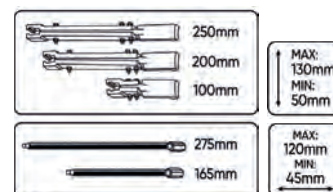

REF. DESCRIPTION

REF.	DESCRIPTION	Kg	SUB	QTY	€
14611	CLAW TIP FOR REF.53701	0.10	-	50	12,00€
14612	165MM SCREW FOR REF.53701	0.15	-	20	11,00€
14613	275MM SCREW FOR REF.53701	0.30	-	20	13,50€

53062

99,00€

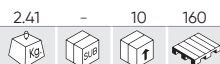

BALL BEARING PULLER KIT WITH BALL ENDED PULLER ADAPTER

22 PCS
5, 6, 8, 9, 11, 12.5mm

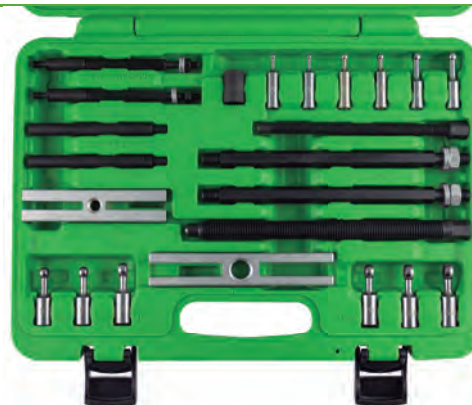

51140

64,00€



CRANKSHAFT GEAR AND PULLEY PULLER

- Designed to hold the pulley of the camshaft still while it is loosened.
- Allows adjustment of the central shaft when they are connected.
- Using the centred screwed bar to pull up the pulley.
- Lockscrews: M6, M8.



51500

29,00€



RIBBED DRIVE PULLEY PULLER

- Suitable for use in crankcases, alternators, air conditioning units and water pumps.
- The low profile arms allow easy access to the difficult areas of the engine.
- Designed for removal of ribbed, obstructed crankcases and auxiliary pulleys.
- Rang: 40-160mm.



40-168mm

52494

227,00€

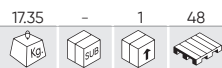

UNIVERSAL BUSH AND BEARING REMOVAL TOOL SET

- Master press and Pul Sleeve Kit.
- For the removal and installation of bushes / bearings and seals, etc.
- Universal applications on both cars and light commercial vans.
- Measurements: M10, M12, M14, M16, M18.

ADAPTERS (OUTER/INNER DIAMETER):

90/80, 85/75, 82/72, 80/70, 78/68, 76/66, 74/64, 72/62, 70/60, 68/58, 66/56, 64/54, 62/52, 60/50, 58/48, 56/46, 54/44, 52/42, 50/40, 48/38, 46/36, 44/34

REF.	DESCRIPTION	Kg	m³	Units	€
12926	M10 SPARE SCREW FOR 52494	0.46	-	20 1500	21,50€
12927	M12 SPARE SCREW FOR 52494	0.52	-	20 -	21,50€
12928	M14 SPARE SCREW FOR 52494	0.60	-	30 1500	22,00€
12929	M16 SPARE SCREW FOR 52494	0.66	-	20 -	23,00€
12930	M18 SPARE SCREW FOR 52494	0.89	-	30 -	23,50€



51124

88,00€

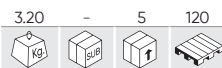

INTERNAL BEARING PULLER SET

5 PCS

UNIVERSAL



CONTAINS

- Universal puller (38,5mm).
- 3/8" to 1/2" adapter (10-14 mm).
- 9/16" to 11/16" adapter (15-19 mm).
- 5/8" to 1" adapter (18-25 mm).
- 1" to 1-1/4" adapter (25-32 mm).

52624

28,00€



HARMONIC BALANCER PULLER SET

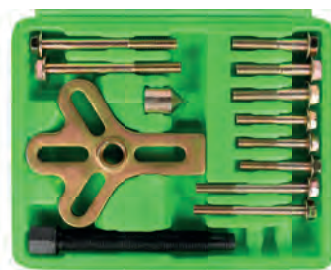

- x2 Crew 5/16" of 4"
- x2 Screw 1/4" of 3"
- x3 Screw 5/16" of 2"
- x3 Screw 1/4" of 2"
- x1 5" Pression screw aluminium alloy
- x1 3/4 Swivel tip

53058

193,00€

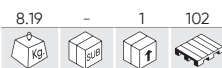

BEARING RACE AND SEAL DRIVER SET



- x49 Ø 18, 19, 20, 21, 22, 23, 24, 25, 26, 27, 28, 29, 30, 31, 32, 33, 34, 35, 36, 37, 38, 39, 40, 41, 42, 43, 44, 45, 46, 47, 48, 49, 50, 51, 52, 53, 54, 55, 56, 57, 58, 59, 60, 61, 62, 63, 64, 65, 74mm
- x1 Metal handle (for use with a hammer) with a diameter of Ø 12mm

53056

127,00€



FRONT WHEEL BEARING TOOL KIT



- x9 Ø 55.5, 59, 62, 65, 66, 71.5, 73, 78, 84mm
- x2 Ø 75.5, 83mm
- x1 Ø 69mm
- x1 295mm

SPECIAL TOOLS

52551

151,00€

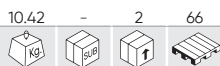

WHEEL BEARING REMOVAL/INSTALLATION TOOL KIT



x13	Pressure plates: 55.7, 63.3, 67.8, 70.7, 71.9, 71.7, 72.8, 73.4, 74.7, 77.4, 81.4, 83.3, 88.4mm
x4	Sleeves: 76, 82, 92, 101mm
x1	Bolt: 27mm
x1	Nut: 32mm
x1	Heavy weight drive screw for use with impact tools
x1	Heavy-duty steel drifts, phosphate coating prevents corrosion

53463

98,00€

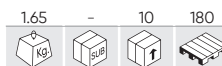

WIPER ARM PULLER SET



VW: Polo, Lupo, Touareg, Porsche Cayenne.
 Opel: Astra G, Zaphira B, Corsa C, Vectra C.
 Honda: Jazz, CRV, FRV, Accord, Turnier.
 BMW: 5th Model from E 39 to 2005. 7th Model from E 38 to 2005
 Audi: A3, A4, A5, A6. Audi Q7.
 Ford: Galaxy, Alhambra.
 Mercedes: A-Class, B-Class.

51349

37,30€

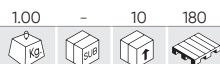

BEARING AND BUSHING INSTALLATOR DRIVER SET



x13	42 - 38mm, 40 - 35mm, 36 - 32mm, 30 - 28mm, 24 - 22mm, 27 - 25mm, 18 - 16mm, 20 - 18mm, 22 - 20mm, 12 - 10mm, 14 - 12mm, 16 - 14mm, 17 - 15mm
------------	---

53059

52,00€

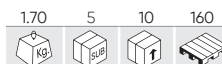

ALUMINIUM BEARING RACE & SEAL DRIVER SET



x9	Ø 39.5, 44.5, 50, 59, 63, 65, 72, 76, 81mm
-----------	--

52056

66,00€



8 PIECE SOCKET SET FOR TORQUE MULTIPLIER

SPARE PARTS AVAILABLE

REF.	DESCRIPTION	Kg	Sub	Qty	€
16385	22MM 1" SOCKET SET FOR TORQUE MULTIPLIER	0.50	-	50	10,00€
16386	24MM 1" SOCKET SET FOR TORQUE MULTIPLIER	0.45	-	50	11,50€
10674	27MM SOCKET FOR REF. 52056	0.59	-	50	9,50€
10675	1" - 30MM SOCKET FOR REF. 52056	0.55	-	50	9,50€
10672	32MM 1" SOCKET SET FOR TORQUE MULTIPLIER	0.66	-	50	9,50€
10673	33MM 1" SOCKET SET FOR TORQUE MULTIPLIER	0.67	-	50	9,50€
16388	38MM 1" SOCKET SET FOR TORQUE MULTIPLIER	0.70	-	50	11,50€
16389	41MM 1" SOCKET SET FOR TORQUE MULTIPLIER	0.75	-	-	11,50€



TIMING TOOLS

- 244 FIAT/ALFA ROMEO
- 249 BMW/MINI
- 258 PSA
- 261 FORD
- 267 JAGUAR/LAND ROVER
- 269 JEEP/CHRYSLER
- 270 MERCEDES-BENZ
- 273 RENAULT/DACIA/NISSAN
- 278 OPEL/VAUXHALL
- 283 VAG
- 295 OTHERS
- 297 ADDITIONAL TOOLS



53303

89,00€

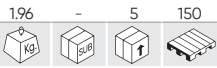

ENGINE TIMING TOOL SET FIAT / OPEL

APPLICATIONS	<p>FIAT: 1.9D/JTD (MOTOR PEUGEOT), 2.4D. ALFA ROMEO: 145, 146, 156 JTD. GM: GM 1.3, 1.6, 1.9, 2.0, 2.4 CDTI (2004 -).</p>
OEM TOOLS	<p>EN-46789 (1), EN-46789-100 (2), EN-46785 (3), EN-46788 (4), EN-46781 (5), EN-46789 (6)</p>
ENGINE CODES	<p>GM: K1.3 CDTI Z13DT COMMON RAIL ENGINE. 1.9 CDTI / 04-12 - Z19DT Z19DTH Z19DTJ Z19DTL 2.0 CDTI / 08-12 - A20DT LBS / LBX / LBY / LCD.V SAAB: 1.9 TID.</p>



53304

279,00€

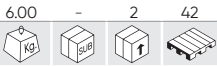

ENGINE TIMING TOOL SET FIAT

APPLICATIONS	<p>FIAT</p>
OEM TOOLS	<p>1 860 874 000 (1), 1 860 895 000 (2), 1 860 898 000 (3), 1 860 905 000 (4), 1 860 845 000 (5)</p>
ENGINE CODES	<p>PETROL: FIAT BRAVA , BRAVO, BARCHETTA, CARGO, COUPE, MAREA, PALIO, WEEKEND, PUNTO, MULTILA, STILO, IDEA, DO- BLO TWIN CAM ENGINES - 1.2, 1.4, 1.6, 1.8, 16V GASOIL: FIAT BRAVA, BRAVO, MAREA, WEEKEND, PALIO, PUNTO, MULTIPLA, DOBLO, ULYSSE, DUCATO, STILO JTD DIESEL ENGI- NES - 1.9D/TD . 1.9JTD . 2.4TD/JTD.</p>

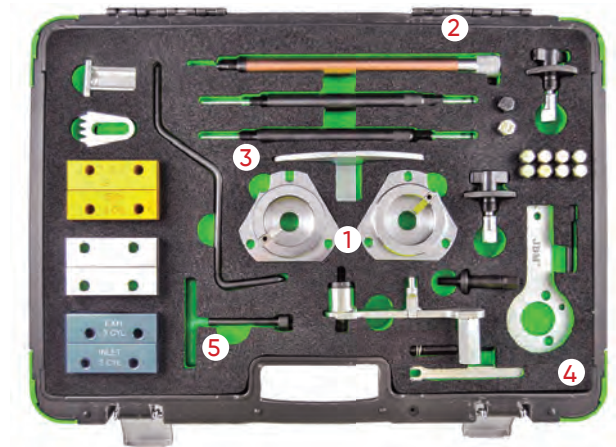

53306

53,00€



ENGINE TIMING TOOL SET FIAT 1.2 16V

APPLICATIONS	<p>FIAT: FIAT 1.2L 16V, FIAT PUNTO / BRAVA / BRAVO / STILO</p>
OEM TOOLS	<p>1860992000 (1) (2), 1871000900 (3), 1860987000 (4), 186985000 (5)</p>
ENGINE CODES	<p>176 B9.000, 182 B2.000, 188 A5.000</p>



53308

55,00€

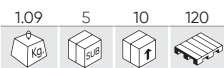
**ENGINE TIMING TOOL SET ALFA ROMEO**

APPLICATIONS	ALFA ROMEO: 145,146,147,155,156, 1.4 1.6 1.8 2.0 TS, 1.4/1.6 16V; 145/146/147/155/156 (96-10), 1.8 16V; 145/146, (96-01), 155/156 (96-06), SPIDER/GTV (98-05), 2.0 16V; 145/146 (96-01), 147 (01-10), 155/156 (95-02), 166 (98-07), SPIDER/GTV (96-05), PÚRPURA / PURPLE: 1.4, 1.6 // AZUL / BLUE: 1.8, 2.0
OEM TOOLS	1822149000 (1), 1822154000 (2), 1825041000 (3), 1825042000 (4)
ENGINE CODES	Z1.4/1.6-321.02, 321.03, 321.04, 335.03, 676.01 1.8/2.0-323.01, 672.04, 162.01, 323.10, 671.06, 322.01, 671.02, 322.05, 341.03, 363.01.

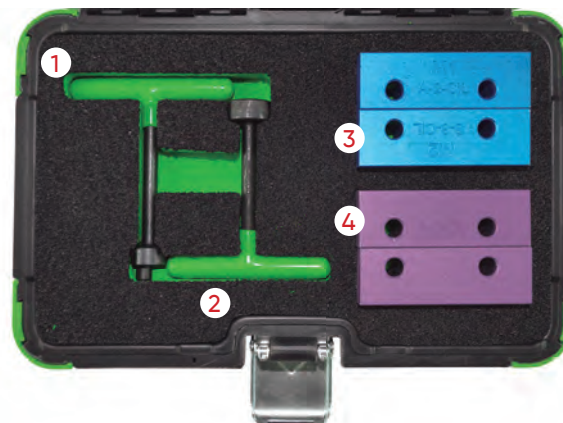
**53309**

285,00€

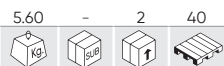
**ENGINE TIMING TOOL SET ALFA/FIAT/LANCIA 1.4, 1.6, 1.8, 2.0 16V**

APPLICATIONS	ALFA ROMEO: 145,146,147,155,156, 1.4 1.6 1.8 2.0 TS, 1.4/1.6 16V; 145/146/147/155/156 (96-10), 1.8 16V; 145/146, (96-01), 155/156 (96-06), SPIDER/GTV (98-05), 2.0 16V; 145/146 (96-01), 147 (01-10), 155/156 (95-02), 166 (98-07), SPIDER/GTV (96-05), PURPUR: 1.4, 1.6 // BLAU: 1.8, 2.0 FIAT: BARCHETTA (96-00), BRAVA (95-00), BRAVO (95-0 0), COUPE (96-01), MAREA (96-00), MAREA WEEKEND (96-00), PUNTO/PUNTO CLASSIC (99-06), STILO (01-08) LANCIA: DEDRA (95-99), DELTA (96-99), KAPPA (98-02), LYBRA (99-06).
OEM TOOLS	1.4 16V: 335.03 1.6 16V: 321.02, 321.03, 321.04, 372.03, 676.01 1.8 16V: 322.01, 322.05, 671.06, 182A2.000, 183A1.000, 183A6.000, 188A6.000, 192A4.000 2.0 16V: 162.01, 323.01, 323.1, 341.03, 363.01, 672.04 2.0 20V: 175A3.000, 182A1.000, 182B7.000, 185A8.000.

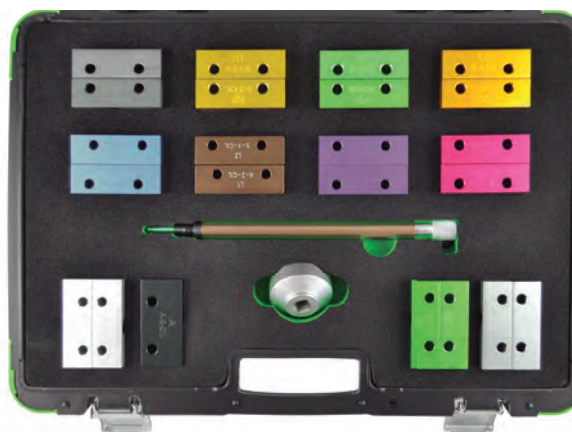
**53310**

498,00€

**ENGINE TIMING TOOL SET FIAT/ALFA/LANCIA**

APPLICATIONS	ALFA FIAT LANCIA	ALLA, BARCHETTA, BRAVO, BRAVA, COUPE, DELTA, DEDRA, PUNTO, SPIDER, GT
OEM TOOLS	1860845000 (1), 1822154000 (2), 1860905000 (3), 1860992000 (4), 1860895000 (5), 1860874000 (6), 1860985000 (7), KM571A (8), 1860896000 (9), 0153A (10)	
ENGINE CODES	1.2 / 16V, 1.4 / 12V, 1.6 / 16V, 1.6 ECO. 1.8, 2.0 / 16V, 2.0 / 20V, 2.4 / 20V, 3.0 / V6.	



53312

127,00€

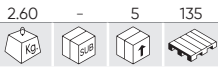

ENGINE TIMING TOOL SET FIAT/ALFA/FORD

APPLICATIONS	FIAT: NEW 500 (07-09), IDEA (04-09), LINEA (07-09), GRANDE PUNTO (07-09), DOBLO 1 CARGO (05-09), PANDA EV02 (05) FORD: KA 1.2 DURATEC (09) ALFA ROMEO
OEM TOOLS	1 860 987 000 (1), 2 000 004 400 (2), 2 000 015 800 (3), 2 000 004 300 (4), 2 000 004 500 (5)
ENGINE CODES	1.2: 169A4.000 / 199A4.000 . 1.4: 350A 1.000 / 188A4.000-EV02.

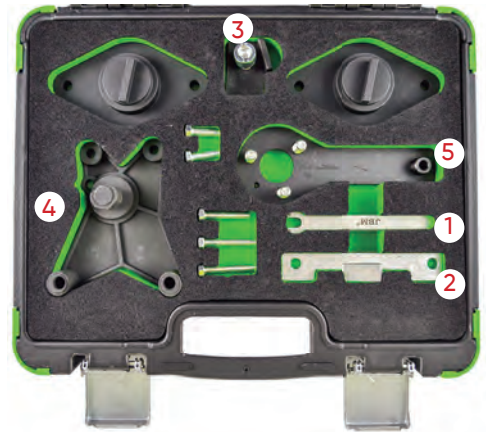

53319

18,00€

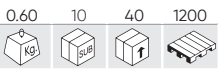

ENGINE TIMING TOOL SET FIAT IVECO 2.3, 3.0 JTD

APPLICATIONS	FIAT: 2.3 / 3.0 JTD. IVECO: DAILY.
OEM TOOLS	99360614, 1860 617 000, 99360615, 2 000 018 200.
ENGINE CODES	F1AE0481C, F1AE0481D, F1AE0481N, F1CE0481A/D.

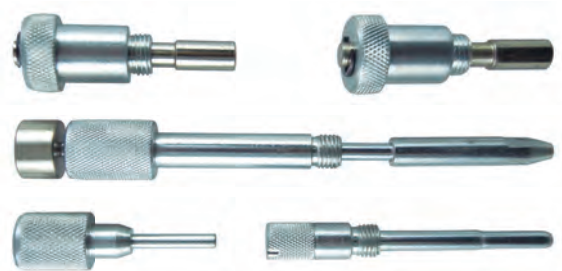

54202

68,00€



ENGINE TIMING TOOL SET FOR FIAT/ALFA ROMEO/LANCIA

APPLICATIONS	ALFA ROMEO: GIULIETTA (10-14), MITO (08-17). FIAT: 500 (07-19), 500L (12-19), 500C (07-19), 500 ABARTH (08-17), BRAVO (07-14), BRAVA/BRAVO (98-02), DOBLO/DOBLO CARGO (10-19), EGEA (15-20), GRANDE PUNTO (07-10), GRANDE PUNTO ABARTH (07-10), IDEA (04-12), LINEA (07-10), MAREA/WEEKEND (98-00), PALIO WEEKEND (01-06), PANDA (07-11), PUNTO (97-08), STILO (01-08), TIPO (15-20). LANCIA: DELTA (08-12), MUSA (04-13), YPSILON (96-11).
OEM TOOLS	2.000.004.500 (1), 1.860.985.000 (2), 1.860.992.000 (3), 1.860.987.000 (4), 2.000.015.800 (5)
ENGINE CODES	1.2 16V:176B9.000, 182B2.000, 188A5.000. 1.4 16V / T-JET: 169A3.000, 192B2.000, 198A1.000, 198A4.000, 199A6.000, 198A8.000, , 312A1.000, 312A3.000, 843A1.000, 955A1.000.

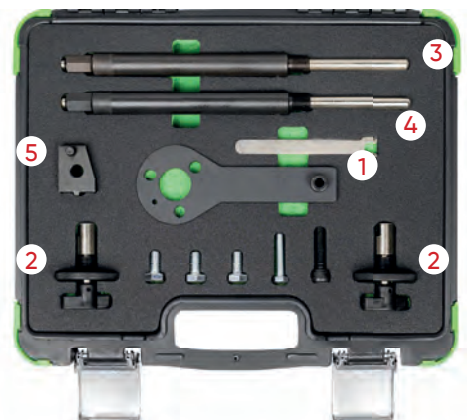

54203

91,00€



ENGINE TIMING TOOL SET FOR ALFA ROMEO/LANCIA 1.8 TBI

APPLICATIONS	ALFA ROMEO: 159(09-12), BRERA(09-11), GIULIETTA(10-19), SPIDER(09-11), 4C(13-19). LANCIA: DELTA(09-14).
OEM TOOLS	2 000033500 (1), 2000 003000 (2), 1860898 000 (3).
ENGINE CODES	ALFA ROMEO 1,75 TBI: 939B1.000, 940A1.000, 940B2.000, 960A1.000 LANCIA 1,75 DI TURBO JET: 939B1.000

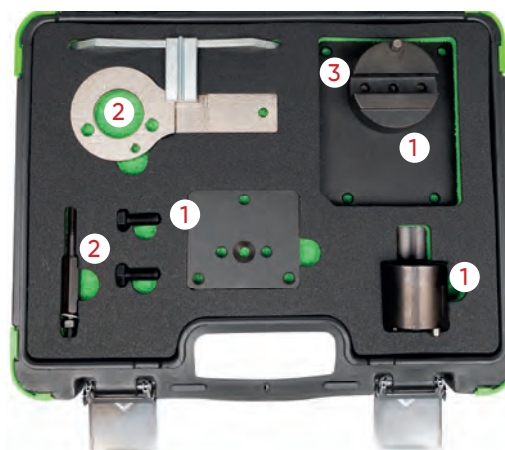

54211

74,00€



ENGINE TIMING TOOL SET FOR FIAT/FORD/OPEL/SUZUKI 1.3L

APPLICATIONS	FIAT: PUNTO (2003-2007) / PANDA (2003-2009) / IDEA (2004-2006) / DOBLO (2004-2006). FORD: KA. VAUXHALL / OPEL: AGILA (2003-2008) / CORSA C (2003-2007) / CORSA D (2006-2009) / COMBO C (2003-2009) / ASTRA H (2004-2009) TIGRA B (2004-2009) / MERIVA (2004-2009). SUZUKI: IGNIS (2003-2009) / WAGON R (2003-2009) / SWIFT (2003-2010).
OEM TOOLS	1871000200 / 303-1469 / KM-662-C (1), EN 46785 / KM 955 / 09912-38300 (2), 1871000900 / 1860985000 / 303-1472 / EN 46781 / 09917-68610 (3), 1870900400 (4), 1870900300 / 303-1468 (5)
ENGINE CODES	FIAT: 1.3 JTD 188A9.000 / 169A.000 / 188A8.000 / 199A3.000. FORD: 1.3 TDCI. VAUXHALL / OPEL: 1.3 CDTI Z13DT / Z13DTH / Z13DTJ. SUZUKI: 1.3 CDTI Z13DT.

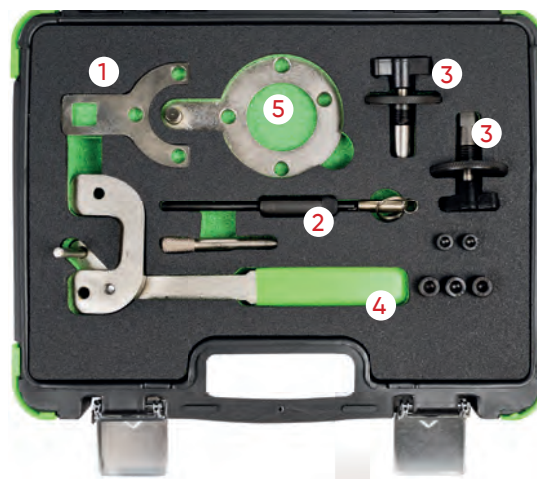

54212

39,40€



ENGINE TIMING TOOL SET FOR FIAT/LANCIA 1,4 12V

APPLICATIONS	MAREA/MAREA_WEEKEND(96-20), BRAVA(95-98), BRAVO(95-98). LANCIA: YPSILON(96-20)
OEM TOOLS	1860899000 (1), 1860901000 (2)
ENGINE CODES	1.4 12V : 182A3.000, 182A5.000.



54215

57,00€

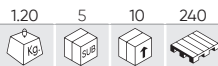

ENGINE TIMING TOOL KIT FOR ALFA ROMEO/FIAT 1.4 MULTIAIR

APPLICATIONS	ALFA ROMEO GIULIETTA, MITO / FIAT PUNTO, PUNTO EVO 1.4 (TURBO) MULTIAIR (105/135/163/170PS)
OEM TOOLS	ALFA ROMEO / FIAT: 1860987000 (1), 2000034400 (2), 2000004500 (3)
ENGINE CODES	940A2.000 / 940A2.000 / 955A8.000 / 955A8.000 / 940A2.000 / 955A8.000 / 955A2.000 / 955A7.000 / 955A6.000 / 955A8.000



54216

49,00€



ENGINE TIMING TOOL SET FOR FIAT/OPEL/ALFA 1.9, 2.4L 16V

APPLICATIONS	OPEL 1.9, ALFA-ROMEO 1.9-2.4 L DIESEL, FIAT 1.9- 2.4 L DIESEL
OEM TOOLS	OPEL EN-46788 / FIAT 1.860.905.000 / 1.860.905.010 (1) FIAT 1.860.898.000 (2) OPEL EN-46789 / FIAT 1.870.896.900 (3) OPEL KM 6130 / KM 6349 (4)
ENGINE CODES	OPEL 1.9 CDTI Z19DT, Z19DTH, Z19DTJ ALFA-ROMEO 1.9 Y 2.4 L : 323.02, 371.01, 342.02, 325.01, 362.02, 182B9.000, 937A2.000, 937A3.000, 192A5.000, 192B1.000, 937A4.000, 937A5.000, 939A2.000, 939A1.000, 939A7.000, 939A8.000, 839A6.000, 841C.000 FIAT 1.9 Y 2.4 L : 182B4.000, 182B9.000, 185A6.000, 186A6.000, 186A8.000, 186A9.000, 188A2.000, 188A7.000, 188B2.000, 192A1.000, 192A3.000, 192A5.000, 192A8.000, 192A9.000, 192B4.000, 192B5.000, 198A2.000, 198A3.000, 198A6.000, 199A5.000, 223A7.000, 937A5.000, 939A1.000, 939A2.000, 939A3.000, 939A7.000



54430

34,00€

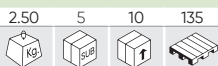

ENGINE TIMING TOOL ALFA ROMEO/FIAT/LANCIA 0.9 TWIN AIR

APPLICATIONS	ALFA ROMEO: MITO (2001-2018) CHRYSLER: YPSILON (2011-2015) FIAT: 500/500C (2010-2020), 500L/500L LIVING/500L MPW (2012-2018), PUNTO (2012-2018), PANDA (2012-) LANCIA: YPSILON (2011-2018)
OEM TOOLS	2 000 035 100 (1) 2 000 035 200 (2) 2 000 035 300 (3)
ENGINE CODES	Q.9: 199B6.000, 199B7.000, 312A2.000, 312A4.000, 312A5.000, 312A6.000, 312A7.000



53259

97,00€

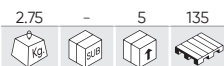

PETROL ENGINE SETTING/LOCKING KIT BMW N42, N46 1.8, 2.0 CHAIN

APPLICATIONS	<p>BMW 1 SERIES: 118i E81/82/87/88 (04-14), 120i E81/82/87/88 (04-14).</p> <p>BMW 3 SERIES: 316i/TI COMPACT E46 (01-07), 318i/TI COMPACT E46 (01-07), 318i, E90/91/92/93 (05-12), 320i E90/91/92/93 (05-12).</p> <p>BMW 5 SERIES: 520i E60/61 (07-10), Z4 2.0 E85/86 (04-09).</p> <p>BMW X SERIES: X1 SDRIVE 18i E84 (10-12), X1 XDRIVE 18i E84 (10-12), X3 2.0 E83 (05-10).</p>
OEM TOOLS	119350 (1), 119340 (2), 119291 (3), 119292 (4), 119270 (5), 115120 (6), 119190 (7), 119293 (8)
ENGINE CODES	1.8: N42; B18A, N46; B18. / 2.0: N42; B20A, N46; B20, B20B, N46T; B20, B20B, B20BD, B20BZ, B20O2, B2O2.



53260

168,00€

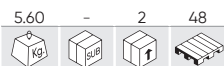

CHAIN DRIVEN ENGINE LOCKING KIT BMW N43 ENGINE PETROL 1.6/2.0

APPLICATIONS	<p>BMW 1 SERIES: 116i E81/82/87/88 (07-12), 118i E81/82/87/88 (06-14), 120i E81/82/87/88 (06-14).</p> <p>BMW 3 SERIES: 316i E90/91/92/93 (07-11), 318i E90/91/92/93 (07-13), 320i E90/91/92/93 (07-14).</p> <p>BMW 5 SERIES: 520i E60/61 (07-10).</p>
OEM TOOLS	118690 (118691/118692/118693) (1), 118710 (118711/118712) (2), 113340 (3) (4), 118700 (5), 119340 (119341/119342) (6), 115120 (7).
ENGINE CODES	1.6: N43 B16A/AA, B16AA, B16AA/OO. 2.0: N43 B20A, B20A/AA, B20AA, B20AY, B20KO, B20UO.

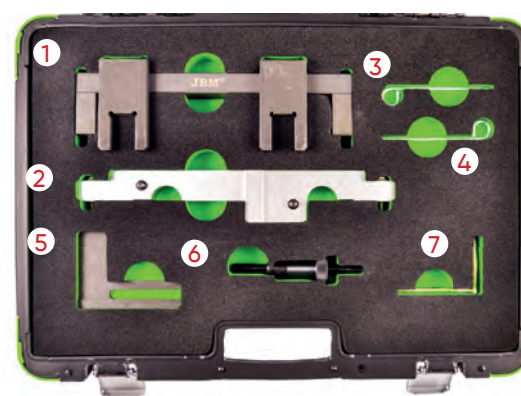

53261

214,00€

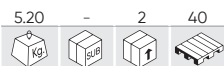

PETROL ENGINE TIMMING LOCKING KIT BMW N42, N46 1.8, 2.0

APPLICATIONS	<p>BMW 1 SERIES: 118i E81/82/87/88 (04-14), 120i E81/82/87/88 (04-14).</p> <p>BMW 3 SERIES: 316i/TI COMPACT E46 (01-07), 318i/TI COMPACT E46 (01-07), 318i, E90/91/92/93 (05-12), 320i (E90/91/92/93 (05-14).</p> <p>BMW 5 SERIES: 520i E60/61 (07-10).</p> <p>BMW X SERIES: X1 E84 SDRIVE 18i (10-12), X1 E84 XDRIVE 18i (10-12), X3 E83 2.0 (05-10).</p> <p>BMW Z SERIES: Z4 2.0 E85/86 (04-09).</p>
OEM TOOLS	119190 (1), 119310 (2), 119302 (3)
ENGINE CODES	2.0: N42 B18A, N42 B20A, N46 B18, N46 B20, N46 B20B, N46T B20, N46T B20B, N46T B20BD, N46T B20BZ, N46T B20O2, N46T B2O2

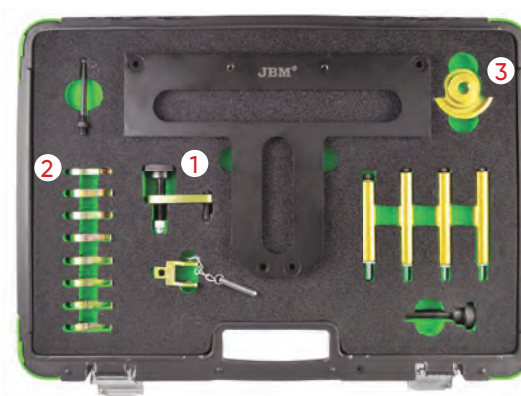

53262

251,00€

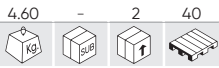

BMW M52TU, M54, M56 DOUBLE VANOS CAMSHAFT ALIGNMENT TOOL

APPLICATIONS	<p>M52TUB25: 1997-2001 E46 323i/323Ci/323Ti (M52T); 1998-2001 E39 523i (M52TU); 1998-2001 E36/7 Z3 (M52TU). M52TUB28: 1997-2001 E46 328i/328Ci (M52TU); 1997-2001 E36/7 Z3 2.8 (M52B28/Z3); 1998-2001 E39 528i (M52TU); 1998-2001 E38 728i (M52TU). M54B22: 2001-2003 E46 320i/320Ci; 2001-2003 E39 520i; 2001-2002 E36 Z3 2.2i; 2003-2005 E85 Z4 2.2i; 2003-2005 E60/E61 520i. M54B25: 2001-2002 E36/7 Z3 2.5i; 2001-2005 E46 325i/325Xi; 2001-2006 E46 325Ci; 2001-2004 E46 325Ti; 2001-2004 E39 525i; 2003-2004 E60/E61 525i/525Xi; 2004-2006 E83 X3 2.5i; 2004-2006 E85 Z4 2.5i. M54B30: 2001-2005 E46 330i/330Xi; 2001-2006 E46 330Ci; 2001-2003 E39 530i/2001-2002 E36 Z3 3.0i; 2003-2005 BMW E60 530i; 2003-2006 E85 Z4 3.0i; 2001-2006 E53 X5 3.0i.</p>
OEM TOOLS	116150 (1), 113450 (2), 113292 (3), 116180 (4), 114220(5)



53263

57,00€

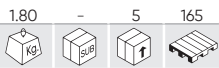

CAMSHAFT ALIGNMENT TOOL BMW M47 LAND ROVER TD4,TD6

APPLICATIONS	<p>BMW 1 SERIES: 118D E87 (04-07), 120D E87 (04-07). BMW 3 SERIES: 318D/TD COMPACT E46 (01-05), 318D/TD E90/91 (05-08), 320D/TD COMPACT E46 (98-05), 320D/CD E90/91 (05-08), 325D E90/91/92/93 (02-10), 330D/CD E46/90/91/92/93 (99-07), 335D E90/91/92 (06-11). BMW 5 SERIES: 520D E39/60/61 (00-09), 525D/XD E39/60/61 (00-10), 530D/XD E46/60/61 (98-10), 535D E60/61 (04-10). BMW 6 SERIES: 635D E63/64 (07-11). BMW 7 SERIES: 730D/LD E38/65/66 (98-08). BMW X SERIES: X3 2.0D E83 (04-07), X3 3.0D/SD E83 (03-10), X5 3.0D E53/E70 (00-10), X6 3.0D E71/72 (08-10), X6 3.5D E71/72 (08-10). LAND ROVER: FREELANDER TD4 (00-06), RANGE ROVER TD6 (02-06). MG/ROVER: MG-ZT/T (01-05), ROVER 75 CDT/CDTI (99-05). VAUXHALL/OPEL: OMEGA-B (01-03).</p>
OEM TOOLS	112300/12-108, 12-171/KM-813 (1), 113340/12-172/KM-823 (2) (3), 116322/12-174/KM-6267 (4) 116320 (5)
ENGINE CODES	<p>BM - 2.0D: M47, M47T2, M47TU / 2.5D: M57, M57T2, M57TU / 3.0D: M57, M57T2, M57TU LAND ROVER - 2.0D: 204D3 (TD4) / 3.0D: 306D1 (TD6) MG/ROVER- 2.0D: M47R / 2.0D CDT: M47R VAUXHALL/OPEL- 2.5D: Y25DT</p>



53264

143,00€

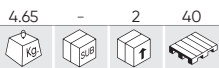

ENGINE CAMSHAFT ALIGNMENT TIMING LOCKING GARAGE TOOL FOR BMW N62, N73

APPLICATIONS	<p>BMW 5 SERIES: 540i E60/61 (05-10), 545i E60/61 (03-06), 550i E60/61 (05-10). BMW 6 SERIES: 645i E63/64 (03-06), 650i E63/64 (05-11). BMW 7 SERIES: 735i E65/66 (02-05), 740i E65/66 (05-10), 745i E65/66 (02-05), 750i E65/66 (05-08), 760i E65/66 (02-08). BMW X SERIES: X5 4.4 E53 (03-07), X5 4.8 E53/E70 (04-10).</p>
OEM TOOLS	119463 (1), 119462 (2), 119340 (3), 119461 (4), 119190 (5)
ENGINE CODES	<p>3.6 V8: N62 B36A 4.4 V8: N62 B44A 4.0 V8: N62 B40A 4.8 V8: N62 B48B 6.0 V12: N73 B60A</p>

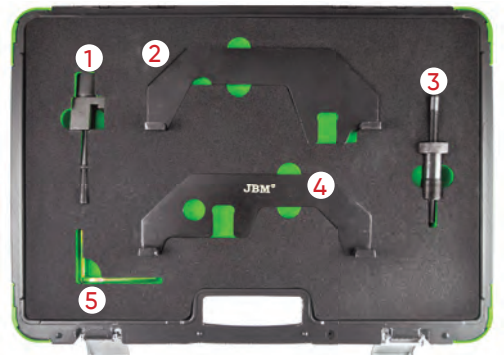

53265

195,00€

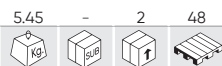
**DIESEL ENGINE TIMING TOOL KIT-BMW M47, M57, M41, M51**

APPLICATIONS	BMW
OEM TOOLS	113360 (1), 116321 (2), 135190 (3), 135191 (4), 135192 (5), 116322 (6), 112300 (7), 113340 (8)
ENGINE CODES	M41 / M51 / M47TU / M47TU T2. M57TU T2 3.01 1998 - 2008.

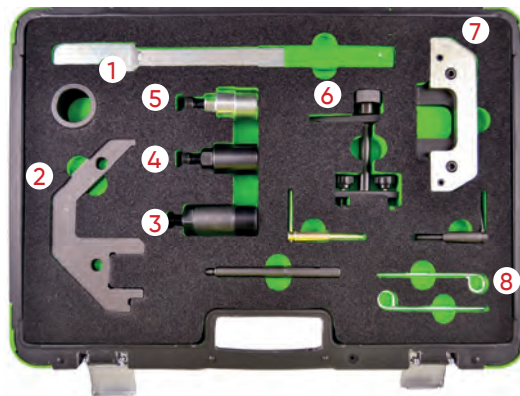
**53266**

224,00€

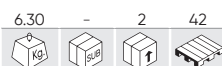
**ENGINE TIMING TOOL SET BMW M42, M43, M50, M51, M52**

APPLICATIONS	BMW
OEM TOOLS	113240 (1), 115490 (2), 113190 (3), 112300 (4) (5), 113292 (6), 113320 (7)
ENGINE CODES	PETROL: M42, M43, M50, M52, M60. DIESEL: M51

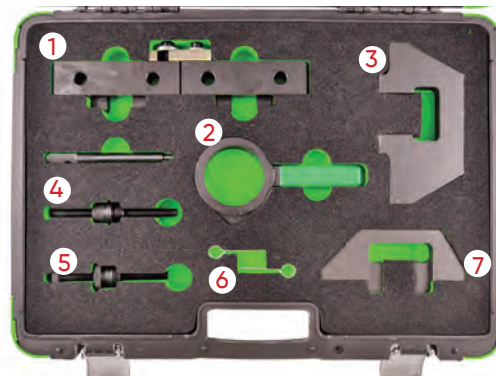
**53267**

277,00€

**TIMING TOOL SET FOR BMW M40, M43, M42, M44, M52, M54, M56**

APPLICATIONS	BMW SERIES: 3, 5, 7, X, Z
OEM TOOLS	114220 (1), 112300 (2), 113240 (3), 115490 (4), 113292 (5), 113450 (6)
ENGINE CODES	M40. M44. M50. M52. M54. M56.

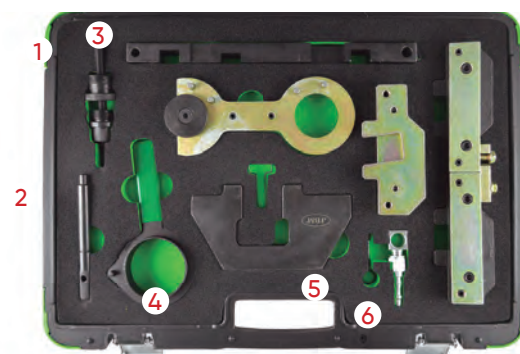

53269

50,00€

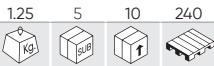

ENGINE TIMING LOCKING TOOLS SET FOR BMW N47, N47S, N57

APPLICATIONS	<p>BMW 1 SERIES: 116D E81/82/87/88 (08-12), 118D E81/82/87/88 (07-14), 120D E81/82/87/88 (07-14), 123D E81/82/87/88 (07-14).</p> <p>BMW 2 SERIES: 218D (11-14), 220D (11-14), 225D (11-14).</p> <p>BMW 3 SERIES: 316D E90/91/92/93 (09-12), 318D E90/91/92/93 (07-12), 320D E90/91/92/93 (07-12), 325D E90/91/92/93 (10-14), 330D/XD E90/91/92/93 (08-14).</p> <p>BMW 5 SERIES: 520D E60/61 (07-10), 525D F10/11 (10-12), 530D F10/11 (10-13), 530DGT F07 (09-12), 535D F10/11 (10-17), 535DGT F07 (10-12).</p> <p>BMW 7 SERIES: 730D/LD F01/02/04 (08-12), 740D F01/02/04 (09-12), 740D XDRIVE F01/02/04 (09-12), 750D XDRIVE F01/02/04 (12-15).</p> <p>BMW X SERIES: X1 SDRIVE 18D E84 (09-15), X1 SDRIVE 20D E84 (09-12), X1 XDRIVE 18D E84 (09-15), X1 XDRIVE 20D E84 (09-15), X1 XDRIVE 23D E84 (09-12), X3 2.0D E83 (07-10), X3 XDRIVE 18D E83 (08-10), X3 XDRIVE 30D E83 (11-12), X3 XDRIVE35D F25 (11-17), X5 3.0D E70 (10-13), X5 XDRIVE 40D X5 F15 M50D (13-17), E70 (10-13), X6 XDRIVE 30D E71/72 (10-14), X6 XDRIVE 40D E71/72 (10-14), X6 F16 M50D (14-17).</p> <p>BMW MINI: PACEMAN (13-17), COUNTRYMAN (10-17), MINI (10-15), ROADSTER (12-14), CLUBMAN (10-14), CLUBVAN (12-14).</p>
OEM TOOLS	118760 (1), 118740 (2), 116480 (3), 115320 (4)
ENGINE CODES	<p>1.6 D: N47; C16K1, C16U1.</p> <p>2.0 D: N47; C20K1, C20U1N47; D20, D20A, D20B, D20D, D20K1, D20O0, D20O1, D20T1, D20U0, D20U1, N47S D20T0, N47T; D20, D20O1, D20U1.</p> <p>3.0 D: N57; B30B, B30B/T0, B30C, D30BT0, D30O0, D30O1, D30T0, D30T1, D30U0.</p>



54206

113,00€

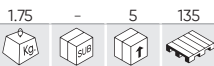

ENGINE TIMING TOOL SET FOR BMW/MINI 1.5 , 2.0L

APPLICATIONS	<p>BMW</p> <ul style="list-style-type: none"> - 1 SERIES - 114D, 116D, 214D - (F20/ 21) - (2015- 2017) - 2 SERIES - 216D, 118D, 125D - (F22/ 23/ 45/ 46) - (2014-2017) - 3 SERIES - 218D, 220D, 225D - (F30/31/34) - (2015-2017) - 4 SERIES - 316D/320D/325D - (F32, 33, 36) - (2015-2017) - 5 SERIES - 420D, 425D, 418D - (F10, 11) - (2014-2017) - X1 SERIES - 518D - (F48) - (2015-2017) - X3 SERIES - (F25) - (2014-2017) - EFFICIENT DYNAMICS - X4 SERIES - (F26) - (2014-2017) - XDRIVE - X5 SERIES - (F15) - (2015-2017) - SDRIVE <p>MINI</p> <ul style="list-style-type: none"> - CLUBMAN - (F54) - (2015-2017) - ONE D CONVERTIBLE - (F57) - (2016-2017) - COOPER D/ SD MINI HATCH (F55, 56) - (2014-2017)
OEM TOOLS	114120 (1), 2347904 (2), 2365488 (3), 2288380 (4), 118760 (5), 118740, 118030 (6)
ENGINE CODES	<p>1.5: B37 D15A, B37 C15A</p> <p>2.0: B47 D20A, B47 D20B, B47 C20A, B47, B47 C20B</p>

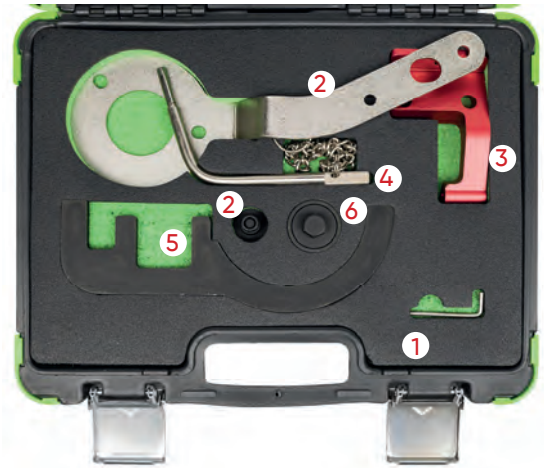

YOUR TIMING TOOL SET EVEN CLOSER

ENTER THE OEM TOOL CODE OR ENGINE CODE OF YOUR CAR IN YOUR WEB BROWSER AND FIND YOUR COMPATIBLE TIMING TOOL

54219

60,00€



ENGINE TIMING TOOL SET FOR BMW/MINI/CITROËN/PEUGEOT

APPLICATIONS	BMW MINI PSA
OEM TOOLS	115140 (1), 119280 (2), 119330 (3), 113340 (4), 114360 (5)
ENGINE CODES	BMW 1.6 (N40 / N45 / N45T, B16, B16A, B16AC) 1.8 / 2.0 (N42 / N46 / N46T) 2.0 / 3.0 (N51 / N52 / N52-COMPONENTE / N53 / N54) PSA 1.4 / 1.6 16V (EP3 / EP6 / EP6DT / EP6DTS) MINI 1.4 / 1.6 (N12 / N14)



54222

59,00€



ENGINE TIMING TOOL FOR MINI 1.6

APPLICATIONS	BMW: MINI COOPER S(07-10) PEUGEOT: 207(06-10), 307(06-10), GT(06-10), THP(06-10), GTI(06-10) CITROËN: DS3(06-10), C4(06-10), GRANDE PICASSO TPH(06-10)
OEM TOOLS	119550(1), 119551(2), 119552(3), 119590(4)
ENGINE CODES	N14 B16A , N14 B16CD , N14 B16TO

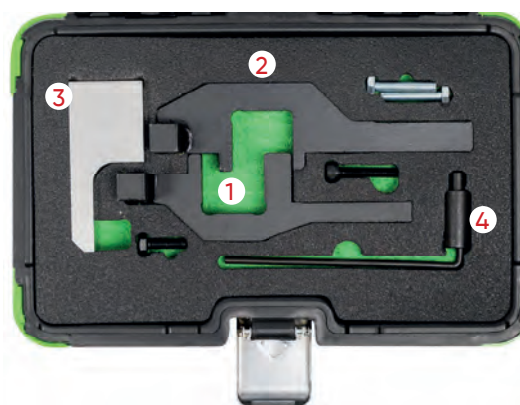

54227

122,00€



ENGINE TIMING TOOL FOR BMW/MINI N13, N18, PSA

OEM TOOLS	EN-52127-2, EN-52588, E1 100, G 1376A, T10550/2, T10550/3, 0 496 709, 0109 2B, 0197 A11, 0197 A3, 0197 A31, 0197-A1, 0197-A1Z, 0197-A11, 0197A2, 0197-A31, 0197-A32, 0197-A33, 0197-BZ, 0197-M, 0197-N, 11 7 440 (1), 11 9 340 (2), 11 9 540, 11 9 551, 11 9 590, 1376-A, 2 299 362 (3)
ENGINE CODES	N12 B14A, N13 B16A, N14 B16A, N14 B16C, N16 B16A, N18 B16A, N18 B16C, 5FA (EP6CDT), 5FD (EP6DTS), 5FE (EP6CDT), 5FE (EP6CDTM), 5FF (EP6DTS), 5FG (EP6CDTR), 5FH (EP6C), 5FK (EP6C), 5FK (EP6CB), 5FL (EP6C), 5FM (EP6CDTM), 5FN (EP6CDT), 5FP (EP6), 5FR (EP6DTE), 5FS (EP6C), 5FT (EP6DT), 5FU (EP6CDTX), 5FV (EP6CDT), 5FW (EP6), 5FX (EP6DT), 5FY (EP6DTS), 5GF (EP6FADTX), 5GF (EP6FADTXD), 5GG (EP6FADTX), 5GM (EP6FDTX), 5GN (EP6FDTR), 5GP (EP6FDTR), 5GR (EP6FDTX), 5GT (EP6FDTX), 5GW (EP6FDT), 5GY (EP6FADTXD), 5GY (EP6FDT), 5GY (EP6FDTM), 5GZ (EP6FDT), 8FN (EP3C), 8FP (EP3C), 8FR (EP3C), 8FS (EP3)



54228

187,00€



ENGINE TIMING TOOL SET FOR BMW/MINI 1.2, 1.5, 2.0, 3.0

APPLICATIONS	BMW: 1 SERIES (2015 - 2019), 2 SERIES (DESDE 2014), 3 SERIES (DESDE 2015), 4 SERIES (DESDE 2015), 5 SERIES (DESDE 2017), 6 SERIES (DESDE 2017), 7 SERIES (DESDE 2015), i8 (DESDE 2014), X1 (DESDE 2015), X2 (DESDE 2018), X3 (DESDE 2017), X4 (DESDE 2018) AND Z4 (DESDE 2019); MINI: CLUBMAN (DESDE 2015), HATCH (DESDE 2014), CONVERTIBLE (DESDE 2016) AND COUNTRYMAN (DESDE 2017)
OEM TOOLS	2 358 122 (1), 2 357 904 (2), 2 365 488 (3), 2 288 380 (4), 11 4 120 (5).
ENGINE CODES	BMW: 1,5 B38 A15A, B38 B15A, B38 K15A ,1,6 B48 B16A, 2,0 B48 A20A, B48 A20B, B48 A20E, B48 B20A, B48 B20B , 3,0 B58 B30A, B58 B30B, B58 B30C MINI: 1,2 B38 A12A , 1,5 B36 A15A, B38 A15A , 2,0 B46 B20A, B48 A20A, B48 A20B

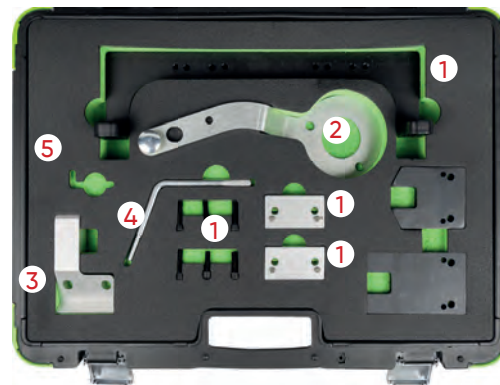

54293

17,50€



CRANKSHAFT COUNTER HOLDER FOR BMW

APPLICATIONS	BMW 1 SERIES E81/82/87/88: 116D (2008-2012),118D (2007-2012),120D (2007-2014), 123D (2007-2014) BMW 1 SERIES E22: 218D (2011-2014), 220D (2011-2014), 225D (2011-2014) BMW 3 SERIES E90/91/92/93: 316D (2007-2012), 318D (2007-2014),320D (2007-2012), 325D (2010-2012), 330D (2008-2014) BMW 5 SERIES E60/61: 520D (2007-2010) BMW 5 SERIES F10/11: 525D (2010-2013), 530D (2010-2013),530D XDRIVE (2011-2015), 535D (2010-2013), 535D XDRIVE (2011-2015),M550D XDRIVE (2012-2015) BMW 5 SERIES E07: 535D GT (2009-2015) BMW 7 SERIES F01/02/04: 730D (2008-2012), 740D (2009-2012),750D XDRIVE (2012-2015) BMW X1 E84: 18D SDRIVE (2009-2015), 20D SDRIVE (2009-2015), 18D XDRIVE (2009-2015), 20D XDRIVE (2009-2015), 23D XDRIVE (2009-2012) BMW X3 E83: 2.0D (2007-2008), 18D XDRIVE (2008-2010) BMW X5 E70: 3.0D XDRIVE (2010-2013), 40D (2010-2013) BMW X6 E71/71: 30D XDRIVE (2010-2014), 40D XDRIVE (2010-2014)
OEM TOOLS	T10016
ENGINE CODES	2,0: N47D20C, N47D20D 2,0D: N47, D20A, D20A/KO, D20B, D20B/TO, D20C,D20O0, D20O1, D20U0, D20U1 D20K1 3,0D: N57, D30U0, D30O0, D30O1, D30T0, D20T0,D30A, D30A/O0, D30B , D30B/T1, D30C, D30C/S1,D30A0/O0, D30A0/O1



54398

41,00€



CRANKSHAFT LOCKING AND TURNING KIT BMW/MINI

APPLICATIONS	MINI HATCH (14-21), CABRIOLET (16-19), CLUBMAN (15-19), COUNTRYMAN (17-19)
OEM TOOLS	11 6 480 (1) 11 9265 (2) 11 4 180 (3) 11 9 810 (4) 11 9 811 (4)
ENGINE CODES	BMW: 116i (15-19), 116d (15-19), 118d (15-19), 120d (15-19), 125d (15-19), M140i (16-19), 214d (15-19), 216i (18-19), 216d (14-20), 218d (17-19), 218i (15-21), 220d, (14-20), 225d (15-20), M240i (16-19), 316d (15-19), 318i (15-19), 320d (15-19), X1 (15-20),X2 (18-19), X3 (14-18), X4 (17-20), X5 (15-18), i8 (14-18) 325d (16-20),330i (15-20), 340i (15-19), 418i (15-20), 420d (15-20), 425d (16-18), 430i (16-20),440i (16-19), 518d (14-17), 525d (17-20), 530i (17-18), 540i (17-19), 620d (18-20), 630i (17-19), 640i (17-19), 725d (16-19), 730i, (15-19), 740i (15-19)



54399

56,50€



N

ENGINE TIMING TOOLS BMW/ROVER/OPEL 2.5D

APPLICATIONS	BMW: 318TDS (94-00), 325TD (91-99), 325TDS (91-99), 525TD (90-03), 525TDS (90-03), 725TDS (95-02) RANGE ROVER: P38 (94-02) VAUXHALL/OPEL: OMEGA-B (94-01)
OEM TOOLS	KM811 (1), 113320 (1), 12112 (1) KM822 (2), 113360 (2), 12115 (2) KM813 (3), 115120 (3), 112300 (3), 12108 (3) KM823 (4), 113340 (4), 12172 (4)
ENGINE CODES	256T, 25DT, M41/174T1, M51/256T1, M51/256T1L, X25DT

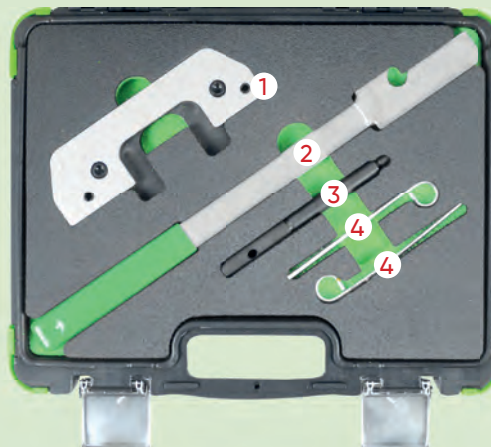

54400

141,00€



N

ENGINE TIMING TOOL SET BMW N20, N26

APPLICATIONS	BMW: 1 SERIES 125I - F20/21 (2012-2016) 2 SERIES COUPE 220I, 228I - F22 (2014-2016) 2 SERIES CABRIOLET 220I 228I - F23 (2015-2016) 3 SERIES 320I 328I XDRIVE - F30/31 (2012-2015) 3 SERIES GRAN TURISMO 320I, 328I/XDRIVE - F34 (2013-2016) X4 XDRIVE 20I, 28I (F26) 2014 - 2018, X5 XDRIVE40E (F15) 2015 - 2018, Z4 SDRIVE18I, 20I, 28I (E89) 2011 - 2017 4 SERIES COUPE 420I, 428I/XDRIVE - F32(2013-2016), 4 SERIES CABRIOLET 420I, 428I/XDRIVE-F33 (2014-2016) 4 SERIES GRAN COUPE 420I, 428I/XDRIVE F36 (2014-2016) 5 SERIES 520I, 528I/XDRIVE(F10/11) 2010 - 2017, 5 SERIES GRAN TURISMO 528I-(F07) 2013 - 2016, X1 SDRIVE16I, 18I, 20I, XDRIVE20I, 28I-(E84) 2011 - 2015, X3 SDRIVE18I, 20I, XDRIVE20I, 28I (F25) 2011 - 2017
OEM TOOLS	11 9 340/341 (1), 11 9 340A (1), 11 9 341 (1), 119340 (1) 2 212 830 (2) 2 212 831 (3) 2 219 548 (4)
ENGINE CODES	1,6 N20 B16A 2,0 N20 B20 N20 B20A N20 B20A N20 B20B N20 N20B/UO N20 B2000 N20 B2000 N26 B20 B26 B20A

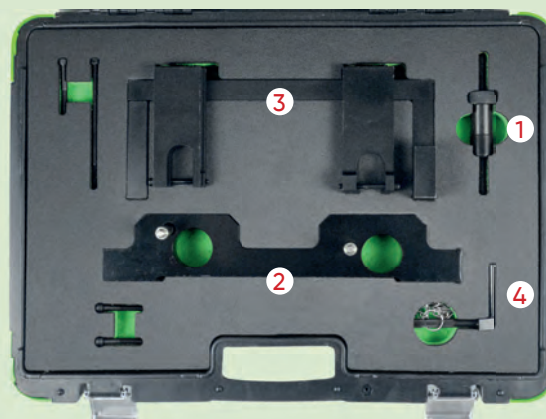

54401

57,00€



N

ENGINE TIMING TOOL SET BMW/MINI N13, N18

APPLICATIONS	BMW 114i (2012-2015) BMW 116i (2012-2015) BMW 118i (2011-2015) BMW 316i (2012-2015) MINI CLUBMAN (R55) (2011-2014) MINI COOPER S (R56/57) (2010-2015) MINI COUNTRYMAN (R60) (2012-2016) MINI COUPE COOPER S (R58) (2012-2015) MINI PACEMAN (R61) (2013-2017) MINI ROADSTER (R59) (2012-2015)
OEM TOOLS	11 7 440 (1), 117440 (2), 11 9 340 (3), 11 9 590 (4), 49 6 709 (5)
ENGINE CODES	N13 B16A N18 B16A N18 B16/MO N18B16A/MO N18B16C N18B16C/TO N18B16MO

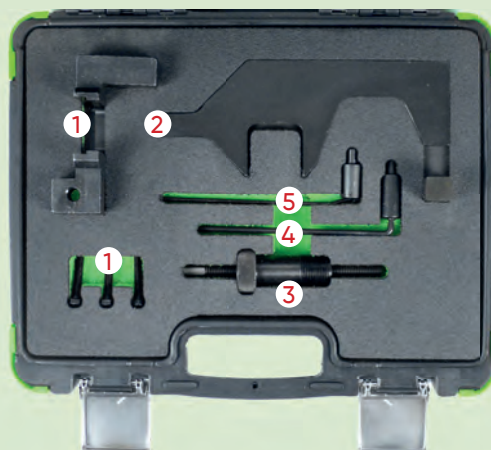

54402

201,00€

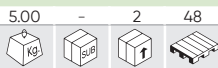

N

ENGINE TIMING TOOL SET BMW N51, N52, N53, N54, N55

APPLICATIONS	E60: 523i, 523Li, 525i, 525Li, 525Xi, 528i, 528Xi, 530i, 530Li, 530Xi, 535i, 535Xi E61/E63: 523i, 525i, 525Xi, 530i, 530Xi, 535Xi, 630i E64/E65: 630i, 730i E66/E70: 730Li, X5 3.0Si E81/E82: 130i, 135iS E83: X3 2.5i, 2.5Si, 3.0i, 3.0Si E85/E86: Z4 2.5i, 2.5Si, 3.0i, 3.0Si, Z4 3.0Si E87/E90: 130i, 323i, 325i, 325Xi, 328i, 328Xi, 330i, 330Xi, 335i, 335Xi E91: 323i, 325i, 325Xi, 328i, 328Xi, 330i, 330Xi, 335i, 335Xi E92: 323i, 325i, 325Xi, 328i, 328Xi, 330i, 330Xi, 335i E93: 325i, 328i, 330i, 335i
OEM TOOLS	110300 (1) 114280 (2) 114285 (3) 114290 (4) 114390 (5) 118520 (6) 119190 (7) 119340 (8)
ENGINE CODES	N51/N52/N53/N54/N55

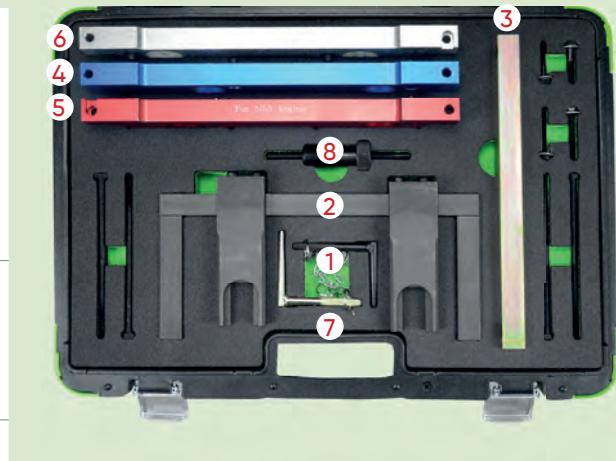

54403

225,00€



N

ENGINE TIMING TOOL SET BMW M60

APPLICATIONS	BMW 5 SERIES: 530i, 540i (E34) (1992 – 1996), 535i, 540i (E39) (1996 – 2003) BMW 7 SERIES: 730i, 735i, 740i (E38) (1994 – 2002), 730i, 740i (E32) (1992 – 1994) BMW 8 SERIES: 840i (E31) (1993 – 1999) LAND ROVER/RANGE ROVER: (L322) (2002 – 2005) X5: 4.4, 4.6 (E53) (1999 – 2004)
OEM TOOLS	11 2 445 (1), 11 2 441/445 (1), LRT -12 223/2 (1) 11 2 441 (2), 12 223/1 (2), LRT 12-223/1 (2) 11 2 442 (3), 11 2 442/446 (3), 12 223/3 (3), LRT 12 223/3 (3) 11 2 446 (4), 12 223/4 (4), LRT 12 223/4 (4), LRT 12 224 (4) 11 3 390 (5), 113390/117380 (5), 12 222 (5), LRT 12 222 (5) 11 5 180 (6), 12 227 (6), LRT 12 227 (6) 11 2 300 (7), 11 5 120 (7), 12 108 (7), 12 171 (7), KM 813 (7), LRT 12 108 (7), LRT 12 171 (7) 11 6 420 (8), 12 226 (8), LRT 12 226 (8) 11 6 452 (9), 12 228/1 (9), LRT 12 228/1 (9) 11 6 451 (10), 12 228/2 (10), LRT 12 228/2 (10) 11 3 310 (11), 12 220 (11), LRT 12 220 (11) 11 6 440 (12), 12 224 (12), LRT 12 2214 (12) 11 7 380 (13), 12 221 (13), LRT 12 221 (13)
ENGINE CODES	BMW 3.0: 30 8S 1 BMW 3.5: 35 8S 1, 35 8S 2 BMW 4.0: 40 8S 1 BMW 4.4: 44 8S 1, 44 8S 2 BMW 4.6: 46 8S 1 RANGE ROVER: V8/44 8S 2



54404

131,00€



N

ENGINE TIMING TOOLS SET BMW N62, N73

APPLICATIONS	SERIES 5, SERIES 6, SERIES 7, X5
OEM TOOLS	119461 (1), 119462 (2), 119463 (3), 119190 (4), 119340 (5), 119451 (6), 119452 (7), 119453 (8), 119454 (9), 113460 (10), B117207 (11)
ENGINE CODES	N62 B36A, N62 B40A, N62 B44A, N62 B48A, N62 B48B, N73 B60A

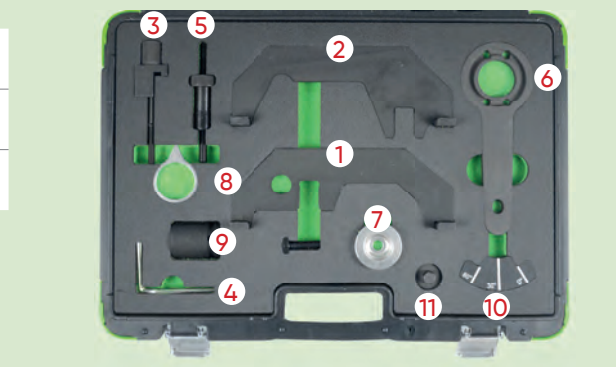

54405

111,00€



N

ENGINE TIMING TOOL SET BMW N63, N74

APPLICATIONS	SERIES 5, SERIES 6, SERIES 7, X5, X6
OEM TOOLS	11 9 891 (1) 11 9 892 (1) 11 9 893 (2) 11 9 190 (3) 11 8 090 (4)
ENGINE CODES	N63, N74

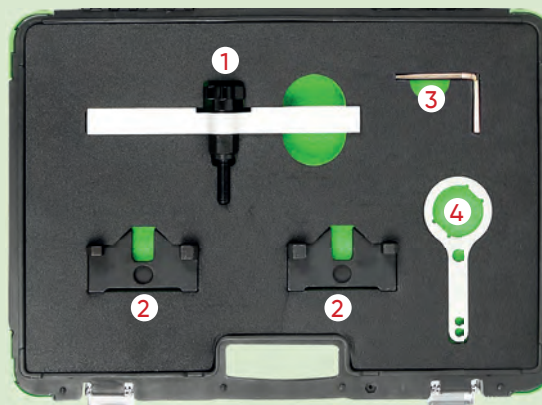

54406

73,00€



N

ENGINE FLYWHEEL BLOCKER BMW/MINI

APPLICATIONS	<p>BMW 1 SERIES: F20/21 (12-15), 116i (04-12), 118i (04-14), 120i (04-14), 130i (05-07), 135i (07-11), 116D (08-12), 118D (04-14), 120D (04-14), 123D (07-14), M COUPE (11-12)</p> <p>BMW 3 SERIES: F30/31 (12-15), 316Ti (04-14), 316i (04-11), 316D (09-12), 318i (04-07), 318Ti/COMPACT (04-04)</p> <p>BMW 3 SERIES: 318D (03-12), 318TD (03-07), 320D (01-07), 320D COMPACT (01-05), 318i (05-13), 320D (07-14), 320i (05-14), (05-14), 320Si (05-06)</p> <p>BMW 3 SERIES: 323i (05-11), 325i (05-14), 325D (06-10), 330D (05-08), 330i (06-13), 335D (05-13), 335i (05-11)</p> <p>BMW 4 SERIES: 420i F32 (13-15), 428i F32 (13-15), 420i F33 CABRIOLET (14-15), 428i F33 CABRIOLET (14-15), 420i F36 (14-15), 428i F36 GRAN COUPE (14-15)</p> <p>BMW 5 SERIES: F10/11 (10-15), 520D (05-10), 520i (07-10) 523i (03-10), 525D (05-10), 525i (05-10), 525i (07-10), 530D (03-10), 530i (05-10), 535D (04-10)</p> <p>BMW 6 SERIES: 630i (04-11), 635D (07-11)</p> <p>BMW 7 SERIES: 730D (05-08), 730i (02-08) BMW X SERIES: X1 E84 (09-15), X3 E83 (03-14), X5 E53 (03-14), X3 F25 (11-15), X6 E71/72 (08-10)</p> <p>BMW Z SERIES: Z4 E85/86 (04-09), Z4 (E89) (11-15)</p> <p>MINI: MINI (03-06)</p>
OEM TOOLS	11 8 180 (1), 11 8 181 (2), 11 8 182 (3), 11 8 183 (4), 11 8 184 (5), 11 8 185 (6)
ENGINE CODES	<p>BMW: M47T2, M57T2, M67, N43, N45, N45T, N46, N46T, N47, N51, N52, N53, N54</p> <p>MINI: W17 DIESEL</p>



54324

11,00€

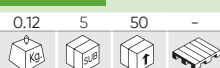

N

TIMING CHAIN WEAR INDICATOR MINI

APPLICATIONS	MINI: CLUBMAN (2007-2014), CLUBVAN (2012-2014), COUNTRYMAN (2010-2017), COUPÉ (2011-2015), MINI (2006-2015), PACEMAN (2013-2017), ROADSTAR (2012-2015)
OEM TOOLS	2353281 (1)
ENGINE CODES	<p>1.4: N12 B14AB, N12 B14</p> <p>1.6: N12 B16A, N16 B16A, N16 B16M0, N16 B16U0, N16 B16A/MO, N16 B16KO, N16 B16A/MO, N18 B16A, N18 B16A/MO, N18 B16C, N18 B16A/MO, N18, N18 B16M0, N18 B16C/T0</p>



53268

92,00€

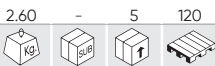

ENGINE TIMING TOOL SET BMW/MINI/PSA 1.4, 1.6

APPLICATIONS	<p>BMW/MINI: MINI CLUBVAN R55 (12-14), MINI CLUBMAN R55 (08-14), MINI COUNTRYMAN R55 (07-10), MINI CLUBMAN R56/R57 (07-15), MINI R56/R57 (08-15), MINI COUPE R58 (11-15), MINI ROADSTER R59 (08-15), MINI CLUBMAN R60 (10-14), MINI CLUBVAN R60 (12-14), MINI ROADSTER R61 (13-15), MINI PACEMAN R61 (14-15), MINI COUNTRYMAN R60 (10-17). CITROËN: C4 (08-11), C4 PICASSO (08-13) C4 GRAND PICASSO (13-15). PEUGEOT: 207 (06-14), 207CC (07-15), 308 (07-15), 3008 (09-15), 5008 (09-15).</p>
OEM TOOLS	<p>BMW/MINI: 115590 (1), 119340 (2), 119551 (3) CITROËN: 0197-A1, 0197-A3, 0197-B. PEUGEOT: 0197-A1, 0197-A3, 0197-BZ.</p>
ENGINE CODES	<p>1.4: N12B14, N14B14AB. 1.6: EP3(8FS), EP3C(8FR), EP6(5FW), EP6C(5FS), EP6CDT(5FV), EP6DT(5FT), EP6DT(5FX), EP6DTS(5FY), N14B16A, N14B16CD, N14B16TO, N14B16CD/TO, N16B16A, N16B16KO, N16B16A/MO, N16B16A/MO, N16B16M0, N16B16U0.</p>



53313

139,00€

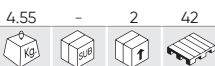

ENGINE TIMING TOOL SET CITROEN/PEUGEOT

APPLICATIONS	<p>CITROËN: AX, BX, BOXER, BERLINGO, C25, DISPATCH, EVASION, J5, JUMPY, JUMPER, RELAY, SAXO, SYNERGIE, VISA, XM, XSARA, XANTIA, XZ, ZX. PEUGEOT: 106, 205, 206, 305, 306, 307, 309, 405, 406, 605, 607, 806, EXPERT, PARTNER, SOLARA, TALBOT.</p>
OEM TOOLS	<p>7099TM (1), 0188X (2), 0188P (3), 0189AZ (4), 0188H (5), 0132AJ1 (6), 0189A (7), 0188PM (8), 21-260 (9), 4527-TS1 (10), M8X70 (11), 0188K (12), 0188J (13), 0132Q (14), 4507-TL (15), 4507-TJ (16), 9044-T (17), 4507-TJ (18), 5711-TA (19), 7014-TJ (20), 7017-TR (21), 0188X (22), 7017-TW (23), 7014-TM (24), 0189L (25)</p>

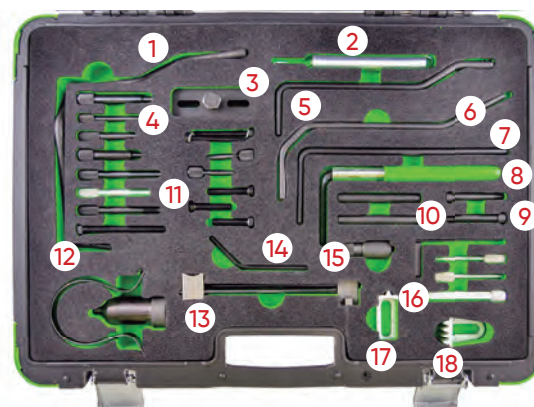

53314

98,00€



ENGINE TIMING TOOL SET CITROEN/PEUGEOT 1.8, 2.0

APPLICATIONS	<p>CITROËN: C4 PICASSO/GRAND PICASSO (06-10), C5 II (04-08), C8 (05-10), DISPATCH/JUMPY (07-11), XSARA 2.0 16V, C5 1.8/2.0/HPI, XSARA PICASSO 1.8/2.0 16V (02-05). PEUGEOT: 406 1.8 16V (00-04), 407 (06-10), 807 2.0 16V (02-05).</p>
OEM TOOLS	<p>0189S2 (1), 0188J (2), 0188J2 (2), 0189S1 (3), 21-260 (4), 0189B (5), 0188M (6), 0188AH (7), 0189R (8)</p>
ENGINE CODES	<p>1.8 16V: EW7A(6FY). 2.0 16V: EW10A(RFJ), EW10ABE4(RFH), EW10J4S (RFK).</p>

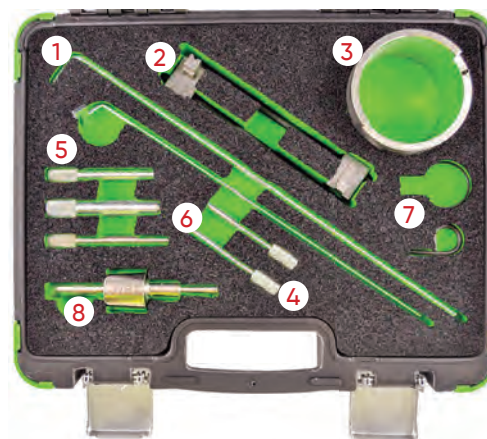

53876

64,00€

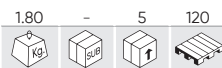

ENGINE TIMING LOCKING TOOLS SET FOR CITROËN/PEUGEOT 1.0, 1.2 VTI

APPLICATIONS	CITROËN: C3 (III) PEUGEOT: 208, 308, 2008 SUV (2012-2014)
OEM TOOLS	0109-2A (1) 0109-2B (2)
ENGINE CODES	1.0/1.2 VTI. EBO, (ZMZ), EB2, (HMZ)

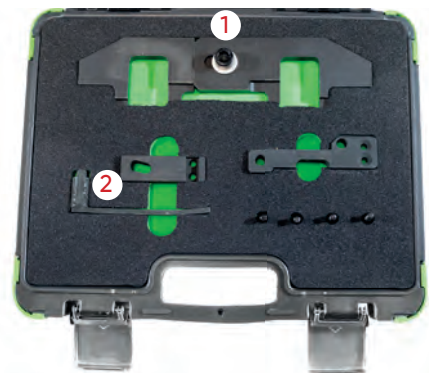

54288

72,50€



TIMING TOOL FOR PSA 1.2 GDI PURETECH

APPLICATIONS	CITROËN: BERLINGO IV (18-20), C1 II (14-18), C3 III (12-17), C3 IV (16-18), C4 CACTUS (14-20), C4 AIRCROSS (18-20), C-ELYSEE (12-18), DS3 (12-18) PEUGEOT: 108 (14-18), 208 (12-21), 2008 (13-21), 301 (12-20), 308 (13-21), 3008 (16-21), 508 (19-21), 5008 (14-21), PARTNER III (15-18) PARTNER IV (18-21) RIFTER (19-21) TOYOTA: AYGO (14-18) GM: CROSSLAND X (17-20), COMBO E (18-20), GRANDLAND X (17-20)
OEM TOOLS	CITROËN: G-0109-6 (2), 0109-2B (1), 0109-2C (3), 0109-2D (4), 0197-N (1) PEUGEOT: G-0109-6 (2), 0109-2B (1), 0109-2C (1), 0109-2D (4), 0197-N (1) VAUXHALL: EN-52127-2 (1), EN-52809 (2)
ENGINE CODES	1.2 VTI: 1PP(HM01), EB2 (HMZ), EB2DTS(HNY), EB2 (HMW), EB2M (HMY), EB2 (HMZ), EB-2DTS(HNY), HMP (EB2FB), HMT(EB2D), HMU(EB2D),HMV (EB2M), HMY (EB2M), HMZ (EB2), HMZ (EB2D), HMZ (EB2F),HMZ (EB2FB) 1.2 E-VTI: HMZ (EB2F), EB2F (HMZ) 1.2 PURETECH THP: HNZ (EB2DT) 1.2 PURETECH VTI: EB2ADS (HNS), EB2D(HMT), EB2ADJ (HNP),EB2ADT (HNK), EB2ADTX (HNN), EB2DTS (HNW), EB2DTM (HNW),EB2DTSM (HNW), EB2FA (HMR), EB2FAD (HMH), EB-2FAD (HMM),EB2DT (HNZ), EB2F (HMX), EB2F (HMT), EB2F(HMZ), EB2DTS(HNY),EB2M(HMY)

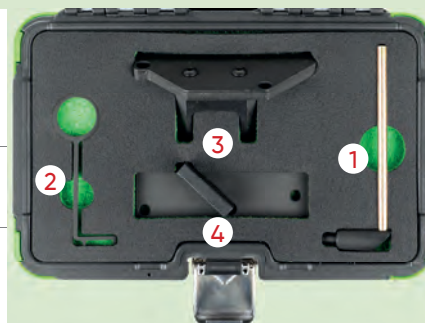

REF. DESCRIPTION

16400 TIMING BELT CHECKING GAUGE PSA (REF.54288)

54323

119,00€



ENGINE TIMING LOCKING TOOLS SET FOR PSA 1.0, 1.2 VTI, 1.2 GDI PURETECH

APPLICATIONS	CITROËN: C1 II (2014-2018), C3 III (2012-2017), C3 IV (2016-2018), C4 CACTUS (2014-2020), C4 AIRCROSS (2018-2020), C-ELYSEE (2012-2018), DS3 (2012-2018), BERLINGO IV (2018-2020), GM: CROSSLAND X (2017-2020), COMBO E (2018-2020), GRANDLAND X (2017-2020) PEUGEOT: 108 (2014-2018), 208 (2012-2021), 2008 (2013-2021), 301 (2012-2020), 308 (2013-2021), 3008 (2016-2021), 508 (2019-2021), 5008 (2014-2021), PARTNER III (2015-2018), PARTNER IV (2018-2021), RIFTER (2019-2021) TOYOTA: AYGO (2014-2018).
OEM TOOLS	EN-52127-2 (1), 0109-2B (1) J-0109-2C (2) J-0109-2D (3) EN-52127-1 (4), 0109-2A21 (4) G-0109-6 (5)
ENGINE CODES	B12XHL (EB2DT), B12XHT (EB2DTS), D12XHL (EB2ADT), D12XHL (HNP/EB2ADT), D12X-HT (EB2ADTS), EBO (ZMZ), EBOF (ZMZ), EB2ADT (HNK), EB2ADT (HNP), EB2ADTD (HNK), EB2ADTS (HNS), EB2ADTX (HNN), EB2DT (HNZ), EB2DTM (HNW), EB2DTS (HNW), EB2DTS (HNY), EB2DTSM (HNW), EB2FA, EB2FAD, F12XHT (EB2ADTS), F12XHT (HNS/EB2ADTS), HMM (EB2FAD), HMM (EB2FAD), HMP (EB2FB), HMR (EB2FA), HMT (EB2), HMT (EB2F), HMU (EB2D), HMU (EB2FD), HMV (EB2M), HMW (EB2), HMX (EB2F), HMY (EB2M), HMZ (EB2), HMZ (EB2F), HNJ (EB2ADTXM), HNK (EB2ADT), HNK (EB2ADTD), HNK/EB2ADTD, HNL (EB2ADTSM), HNN (EB2ADTX), HNP (EB2ADT), HNS (EB2ADTS), HNS/EB2ADTS, HNT (EB2ADTS), HNV (EB2DT), HNV (EB2DTM), HNW (EB2DTS), HNW (EB2DTSM), HNX (EB2DT), HNX (EB2DTS), HNY (EB2DTS), HNZ (EB2DT), HN02, ZMZ (EBO), ZMZ (EBOF), 1PP (HM01)

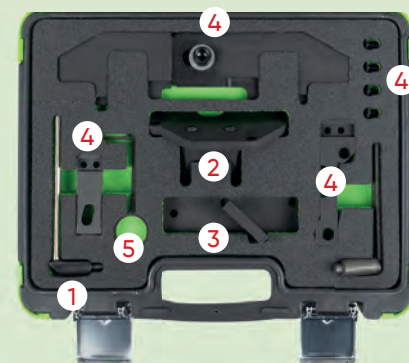

54213

19,80€

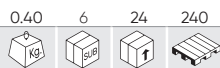

ENGINE TIMING TOOL SET FOR ROVER/PEUGEOT/FORD/VOLVO 2.0, 2.2L D

APPLICATIONS	PEUGEOT: 807 (05-11), 407 (05-11), 607 (05-09).CITROËN: C4 (04-10), C5 II (04-10). LAND ROVER: FREELANDER (06-10). VOLVO: S40 (03-10), V50 (06-10), C70 (06-10), S80 (07-10), C30 906-10), V70 (07-10).FORD: S MAX 2.2 (08-10), GALAXY 2.2 (08-10), MONDEO 2.2, 2.0 (07-10).
OEM TOOLS	PSA 0188.M, FORD 303-735, 303-1277, VOLVO 999-7122 (1) PSA 0188.X, FORD 303-1059, 303-1270, VOLVO 999-7121 (2) PSA 0188.F, FORD 303-393A, 303-393-01, 303-1272, VOLVO 999-7119/7120 (3)
ENGINE CODES	PEUGEOT: DW10UTED4 (RHK), DW10BTED4 (RHR)DW12B-TED4 (4HS), (4HP), (4HT), (4HR). CITROËN: DW10BTED4 (RHR). LAND ROVER:DW12BTED4, 224DT. VOLVO:D420T 2.0D. FORD: QXBA(2.2), QXWA(2.0), QXBB(2.0),Q4BA(2.2), QXWA(2.0), QXWB(2.0), AZBA(2.0), AZBC(2.0), AZWA(2.0)

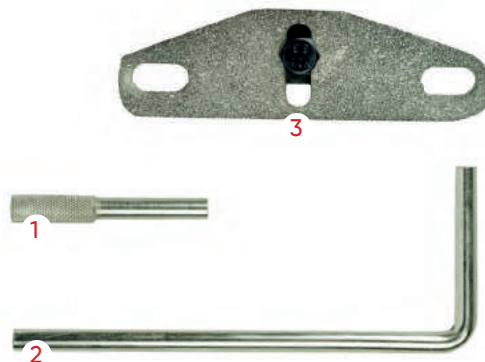

54432

43,00€

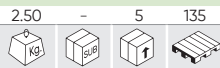

ENGINE TIMING TOOL SET PSA 2.7, 3.0 HDI

APPLICATIONS	CITROËN C6 JAGUAR S-TYPE (X200) 2004 - 2008, XF S (X250) 2008 - 2015, XF S (X260) 2015 - 2020, XJ6 TDV1 (X350/358) 2005 - 2010, XJ (X351) 2010 - 2020, F-PACE S 30D (X761) 2016 - 2020 LAND ROVER: DISCOVERY 3 TDV6 (L319) 2004 - 2009, DISCOVERY 4/DISCOVERY SDV6, TDV6 (L319) 2009 - 2017, DISCOVERY SD6, TD6 (L462) 2017 - 2021, RANGE ROVER SDV6, SDV6 HYBRID, TDV6 (L405) 2012 - 2021, RANGE ROVER SPORT SDV6, TDV6 (L320) 2005 - 2013 PEUGEOT 407, 607 COUPE RANGE ROVER VELAR D275, D300 (L560) 2017 - 2021, RANGE ROVER SPORT SDV6, SDV6 HYBRID, TDV6 (L494) 2013 - 2021
OEM TOOLS	303 11117 (1), 303 11116 (2), 303 1132 (3), 303 1126 (4), 0195H (4), 0195C (5), 0195K (6), 0188-K (7)
ENGINE CODES	2.7: DT17 TED4 (UHZ), DT17BTED4 (UHZ) 3.0: DT20C (X8C/X8Z), DT20CTED4 (X8Z)

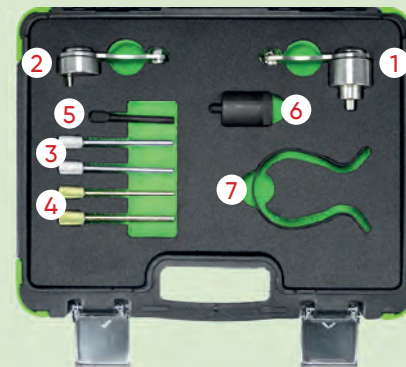

54433

18,00€



ENGINE TIMING TOOL SET PSA 1.0, 1.1, 1.2, 1.4, 1.6, 2.0

APPLICATIONS	CITROËN BERLINGO 2008 - 2011, C2 2003 - 2010, C-ELYSEE 2012 - 2016, C3 PLURIEL 2003 - 2010, C4 2004 - 2011, NEMO 2008 - 2015, XSARA 2000 - 2005 PEUGEOT 106 1998 - 2003, 206 1998 - 2009, 207 2006 - 2013, 306 1998 - 2003, 307 2000 - 2008, 1007 2005 - 2010, PARTNER 1998 - 2011, BIPPER 2008 - 2015
OEM TOOLS	0132QY (1), 4507 TA (1), 0132AK (2), 0153AK (2), 0188K (2), 0189K (2), 1870 900 100 (2), 4533 TAD (2), MOT 1436 (2) 3MM PIN (3), 0132AB (4), 0178D (4), 0194A (4), 77440010400 (4), 1860.617000 (4), 11 9 790 (4), 21-260 (4), 303-732 (4), 4527 TS2 (4), 49 JEO2 018 (4), 5711 TD (4), 99360608 (4), 999 7169 (4), KM-6349 (4), 0132AJ1 (5), 0187B (5), 0189B (5), 0194B (5), 09919 58120 (5), 21 263 (5), 303 735 (5), 3031277 (5), 49 JEO2 021 (5), 607589011500 (5), 8MM DRILL BIT (5), 8MM PIN (5), 999 7122 (5), EN-52137 (5), MOT. 1430 (5), MOT 1430 (5), 0123-RZ (6), 0132R (6), 0153AA (6), 0153AB (6), 0153G (6), 0153ZY (6), 10MM PIN (6), 4507 TB (6), 7014 TN, 9767 27 (6), M10 X 70MM (6), 0132Q (7), 0132QZ (7), 132Z (7), 4507 TA (7)
ENGINE CODES	1.0: TU9 (C1A), TU9/K (C1A), TU9M (CDY/CDZ), TU9MZ (CDY/CDZ), TU9M/L (CDZ), TU9M/L3 (CDY) 1.1: TU1A (HFV/HFX), TU1JP (HFV/HFY/HFZ), TU1JP/L4 (HFV), TU1/K (H1A), TU1M (HDZ), TU1M/L (HDZ), TU1M/L3 (HDY/HDZ), TU1M/Z (HDZ), TU1M+ (HDY/HDZ) 1.4: ET3J4 (KFU), ET3JP4 (KFU), TU3A (KFT/KFV/KFW), TU3FJ2 (K6B/KFZ), TU3FM (KDY), TU3JP (KFW/KFX/KFX), TU3JP/IFL4 (KFX)TU3JP/L3 (KFX), TU3JP/L4 (KFX), TU3JP/IFL4 (KFX), ET3J4 (KFU), TU3M (KDX), TU3M/Z (KDY) 1.6: EC5 (NFP), EC5F (NFP), TU5J2 (NFY/NFW), TU5J4 (NFU), TU5JP (NFT/NFZ), TU5JP/L3 (NFZ), TU5JP/L4 (NFT/NFV), TU5JP4 (NFU), TU5JP4B (NFR), TU5JP4S (NFS), TU5JP4/L3 (NFX), TU5JP4/L4 (NFU/NFX), XU5JP (BFZ) 1.8: XU7JB (LFX), XU7JP (LFW), XU7JP/L3 (LFZ), XU7JP4 (LFY), XU7JP4/L3 (LFY) 2.0: XU10JC/Z (RFU), (RGX), XU10J2E/V (RGX), XU10J2U (RFL), XU10J4R (RFR/RFV), XU10J4R/L3 (RFV), XU10J4RS/L3 (RFS)

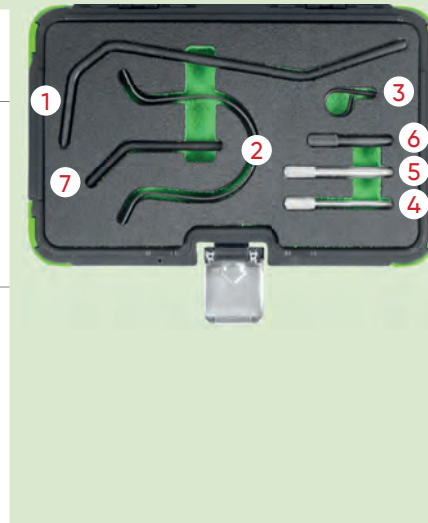

53293

134,00€

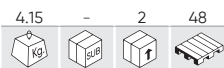

ENGINE TIMING TOOL SET- FORD

APPLICATIONS	B-MAX (12-17), C-MAX (07-17), COUGAR (98-01), COURIER (00-02), ESCORT (94-98), FIESTA (95-17), FOCUS (98-17), FOCUS C-MAX (03-07), FUSION (02-12), GALAXY (06-15), GRAND C-MAX (10-17), KUGA (08-15), MAVERICK (01-07), MONDEO (93-15), ORION (94-94), PUMA (97-02), S-MAX (06-15), TOURNEO CONNECT (02-15), TRANSIT (06-11), TRANSIT CONNECT (02-16), ECOSPORT (13-15), TOURNEO COURIER (14-15), GRAND TOURNEO COURIER (13-15).
OEM TOOLS	303-376 (21-162B) (1), 303-1059 (2), 303-193 (21-104) (3), 303-393-01 (4), 303-1054 (5), 303-1097 (6), 303-748 (7), 303-734 (21-262) (8), 303-651 (21-229) (9), 303-393A (21-168) / 303-393-02 / 303-507 (21-210) / 303-620 (21-163)/ 303-732 (21-260) / 303-735 (21-263).
ENGINE CODES	PETROL: AODA/B, ASDA, ASDB, CFBA, CGBA/B, CHBA/B, CJBA/B, CSDA/B, DHA, DHB, DHC, DHD, DHE, DHF, DHG, EDBB, EDBD, EDDB, EDDC, EDDD, EDDF, EYDB, EYDC, EYDD, EYDE, EYDF, EYDG, EYDI, EYDJ, EYPA, EYPC, F8JA, F8JB, FHA, FHD, FHE, FHF, FUJA, FUJB, FXDA/C, FXDB/D, FXJA, FXJB, FYDA/C, FYDB/D, FYJA, FYJB, HWDA, HWDB, L1F, L1J, L1L, L1N, L1Q, L1T, L1V, L1W, M7JA, M7JB, MHA, MHB, NGA, NGB, NGC, NGD, QQDA/B/C, QQDB, RKA, RKB, RKF, RKH, RKJ, RKK, HXDA. GASOIL: F6JA, F6JB, F6JC, HHJA, HHJB, G8DA, HHDA, HHDB, RTN, RTQ, RTP, C9DC, BHDA/B, BHPA, C9DA/B, F9DA/B, FFBA, FFDA, HCPA, HCPB, KKDA, P7PA, P9PA, QYWA, R2PA, R3PA, RWPA, G6DA, G6DB, G6DC, AZWA, QXWA.

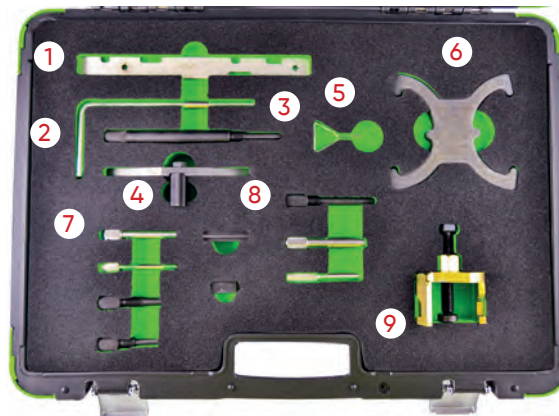

53294

119,00€

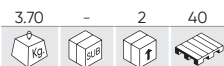

ENGINE TIMING TOOL KIT FORD MAZDA

APPLICATIONS	FORD: COURIER (00-02), C-MAX (03-10), FIESTA (02-11), FOCUS (98-11), FUSION (02-11), GALAXY (06-10), KUGA (06-10), MONDEO (07-10), S-MAX (06-10), TOURNEO CONNECT (02-13), TRANSIT CONNECT (02-13) PEUGEOT: BIPPER (08-10) DISPATCH/JUMPY III (07-12) EXPERT III (07-12) NEMO (08-10) PARTNER I/II (05-11) PARTNER III (08-16) 107 (05-10) 1007 (05-10) 206 (01-12) 206+ (09-13) 206 CC (05-07) 207 (06-13) 207 CC (07-15) 208 (11-15) 307 (01-08) 308 (07-15) 308 CC (09-15) 407 (05-11) 508 (04-15) 2008 (13-15) 3008 (09-15) 4008 (12-15) 5008 (09-15). MAZDA: 2 (02-15), 3 (09-14) CITROËN: C1 (05-10), C2 (03-10), C3 I/II (02-10), C3 III (10-15), C3 PLURIEL (04-10), C3 PICASSO (09-12), C4 (04-11), C4 II (11-15), C4 PICASSO (06-12), C4 GRAND PICASSO (10-12), DS3 (09-12), DS4 (11-12), DS5 (12-15), C5 II (04-08), C5 III (04-12), XSARA II (02-04), XSARA PICASSO (04-10)
OEM TOOLS	FORD: 303-376B (1), 303-193 (2), 303-393 (3), 303-732 (4), 303-651 (5), 303-393/01, 303-1059, 303-734, 303-735, MAZDA: 303-732, 303-734, 303-735. PSA: 0194-A, 0194-C, 0194B.
ENGINE CODES	1.4D TDCi/Hdi: DV4TD(8HT), DV4TD(8HX), DV4TD(8HZ), DV4TD(8HW), DV4TED4(8HX), DV4TED4(8HV), DV4TED4(8HY), DV4C(8HP), DV4C(8HR), DV4TED(8HS), F6JA, F6JB, F6JC. 1.6D TDCi/HDi: DV6TED4(9HZ), DV6ATED4(9HX), DV6TED4(9HY), DV6DTE(9HP), DV6C(9HR), DV6CATED(9HX), DV6C(9HL), DV6TED(9HP), DV6ATED(9HY), DV6TED4(9HV), DV6TED4(9HX), DV6C(9HD), DV6C(BHX), DV6C(BHZ), DV6(9HR), DV6BTED4(9HW), DV6DTE(9HJ), DV6ETED(9HN), DV6ATED4BU(9HS), DV6BTED4(9HT), DV6BUTED4(9HT), DV6TED4B(9HV), DV6UTED4(9HX), DV6TED(9HD), DV6UTED4(9HU), DV6D(9HP), DV6TED4(9HV), DV6C(9HD), DV6TED4(9HW), DV6AT(9HX), DV6ATED(9HX), DV6CTED(9HC), DV6AUTED4(9HX), DV6TED4B, DV6DTE(9HF), HHJA, HHJB, G8DA, G8DB, HHDA, HHDB, MZ-CD, Y6. 1.8D TDCi/HDi: BHPA, C9DA/B, FFBA, G6DA, G6DB, G6DC, HCPA, HCPB, KKDA, P7PA, P9PA, R2PA, R3PA, RWPA. 1.8d: C9DC, RTN, RTQ. 1.8D Td: C9DA/B, C9DC. 2.0D TDCi/HDi: AZWA, G6DA, G6DB, G6DC, RHE(DW10CTED4), QXWA, QXWB.

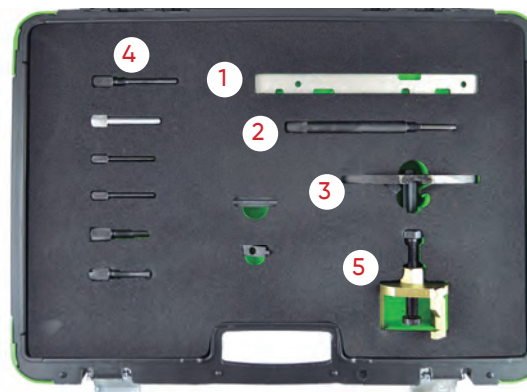

53318

24,00€



CAMSHAFT SPROCKET PULLER FOR FORD

APPLICATIONS	FORD
OEM TOOLS	F8M, F8Q, S8U, S9U.



53295

77,00€

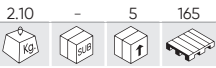

ENGINE TIMING TOOL SET FORD 1,8TDDI, TDCI

APPLICATIONS	C-MAX (07-10), COURIER (00-02), FIESTA (00-02), FOCUS (98-11), FOCUS C-MAX (03-07), GALAXY (06-10), MONDEO (07-10), S-MAX (06-14), TOURNEO CONNECT (02-13), TRANSIT CONNECT (02-13).
OEM TOOLS	303-193 (21-104) (1), 303-393 (21-168) (2), 303-376 (21-162B) (3), 303-652 (21-230) (4), 310-095 (23-067) (5)
ENGINE CODES	1.8D TDCI: BHPA, F9DA, F9DB, FFBA, FFDA, FFWA, HCPA, HCPB, KHBA, KKDA, KKDB, P7PA, P9PA, P9PB, QYBA, QYWA, R2PA, R3PA, RWPA, RWPC. 1.8D TDCI ECONETIC: KHBA. 1.8D TDI: BHDA, BHDB, BHPA, C9DA, C9DB, C9DC. 1.8D TURBO: C9DC, RTN, RTP, RTQ.



53296

60,00€

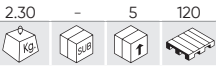

DIESEL SETTING LOCKING AND INJECTION PUMP KIT FOR FORD/JAGUAR DURATORQ

APPLICATIONS	FORD: MONDEO (00-07), TRANSIT (00-14). CITROËN: RELAY, JUMPER III (06-13). FIAT: DUCATO (06-11).	JAGUAR: X-TYPE (03-10). PEUGEOT: BOXER III (06-12). LAND ROVER: DEFENDER TD4 (06-11). LDV: CONVOY (02-06).
OEM TOOLS	303-1151 (1), 303-679A/21-238 (2), 303-732 (3), 303-675/21-234 (4), 303-698/21-251 (5)	
ENGINE CODES	1.2D DI/TDDI/TDCI: ABFA, D3FA, F3FA, D5BA, D6BA, F1FA, FMBA, FMBB, HJBA, HJBB, HJBC, HJBE, N7BA, N7BB. 2.2D TDCI/ECONETIC: BG, CYFA, CYFB, CYFC, DRFA, DRFB, DRFC, P8FA, P8FB, PGFA, PGFB, QJBA, QJBA (BG), QJBB, QJBC, QJBD, QVFA, QWFA, SRFA, SRFB, SRFC, SRFD, SRFE, UHFA. 2.2D HDI/JTD: P22DTE (4HM), P22DTE (4HU), P22DTE (4HV). 2.4D DI/TDCI: DOFA, D2FA, D2FB, D4FA, F4FA, FXFA, H9FA, H9FB, H9FD, JXFA, JXFC, PHFA, PHFC. 2.4D TD/TDI: ZSD 424. 2.4D TD4: 244DT.	



54419

57,00€

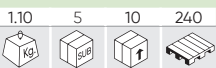

FRONT CRANKSHAFT SEAL PULLER/INSTALLER FORD DURATORQ 2.0, 2.2, 2.4, 3.2

APPLICATIONS	FORD MONDEO 2000 - 2007 RANGER 2011 - ON TRANSIT 2000 - 2006 TRANSIT 2006 - 2014 TRANSIT 2014 - 2019 TRANSIT/TOURNEO CUSTOM 2012 - 2016
OEM TOOLS	21 238 (1), 303-679A (1), 303-682 (2)
ENGINE CODES	2.0 Di ABFA D3FA F3FA 2.0 TDCI FMBA FMBB HJBA HJBB HJBC N7BA N7BB SDBA F1FA 2.0 TDDi D5BA D6BA 2.2 TDCI QJBA QJBB QJBC QJBD GBVAJQF GBVAJQJ GBVAJQW CVRA CVRB CYFA CYFB CYFC CYRA CYRB DRFA DRFB DRFC DRFE DRRR DRRB P8FA P8FB PGFA PGFB QVFA QWFA SRFA SRFB SRFC SRFD SRFE UHFA UHFB 2.4 Di D2FA D2FB D4FA DOFA F4FA FXFA 2.4 TDCI H9FA H9FB H9FD JXFA JXFC 3.2 TDCI SAFA SA2R SA2S SA2W SAFA SAFB



54420

102,00€



N

FUEL ADJUSTMENT SET - FORD / VOLVO 2.5 (EURO 4)

APPLICATIONS	FORD: FOCUS 2.5 RS / ST, MONDEO 2.5, S-MAX 2.5, GALAXY 2.5 ST (2005-) VOLVO: C30 (06-10), C70 (98-10), S40 (96-10), S60 (00-09), S70 (97-07), S80 (98-06), V40 (96-10), V50 (04-10), V70 (97-07), XC70 (02-07), XC90 (02-10)
OEM TOOLS	303-1178 (1), 999 5452 (1), MOT 1337 (1) 303-1182 (2), 999 5451 (2), MOT 1340 (2) 303-1179 (3), 999 5433 (3) 303-1183 (4)
ENGINE CODES	FORD: 2.5 Turbo (Euro 4), HUBA / HUWA / HYDA / JZDA VOLVO: 1.6 (B4164S), 1.8 (B4184S), 1.9T (B4194T), 2.0 (B4204S / B4204T), 2.0T (B5204T3 / B5204T4 / B5204T5), 2.3 (B5234FS), 2.3T (B5234T3 / B5234T7 / B5234T9) VOLVO: 2.4 (B5244S / B5244S2 / B5244S4 / B5244S5 / B5244S7), 2.4T (B5244T / B5244T3 / B5244T4 / B5244T5 / B5244T7), 2.5R (B5254FS), 2.4D (D5244T9 / D5244T8 / D5244T13)

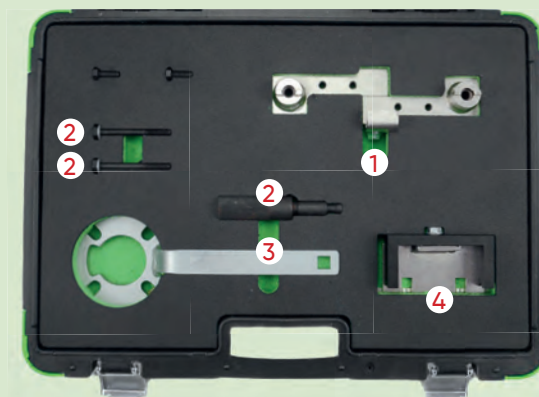

54421

52,00€



N

STRETCH BELT INSTALLATION TOOL FORD/VOLVO 1.4 1.6

APPLICATIONS	FORD 1.4, 1.6 (FOCUS, C-MAX, MONDEO) VOLVO 1.6 (S40, C30, V50)
OEM TOOLS	303-1179
ENGINE CODES	B4164S3, FUJA, FXJA, FYJA C12HM7AD, C12LM7AA, ZH12FUJA, ZH12FUJB, ZH12M7JB C14HDEZ, C14HHADB, ZH14ASDA, ZH14FXDA, ZH14FXDB, ZH14FXDC, ZH14FXDD, ZH14FXJA, ZH14FXJB 16HDEZ, CH16HDEZ, C16HHDEY, ZH16FYDA, ZH16FYDB, ZH16FYDC, ZH16FYDD, ZH16FYDH, ZH16FYJA, ZH16FYJB, ZH16HWDA, ZH16HXDA



54424

64,50€



N

ENGINE TIMING TOOL SET FORD 2.0 ECOBOOST

APPLICATIONS	FOCUS, GALAXY, MONDEO, S-MAX
OEM TOOLS	303-1504 (1) 303-1600 (2), 300-1565 (2) 303-1521 (3) 303-748 (4) 303-1595 (5) 2MM TENSIONER (6)
ENGINE CODES	MGDA, R9CB, R9CD, R9CF, R9CH, R9DA, R9DB, R9DC, R9DD, TNBA, TNBB, TNCC, TNCD, TNCF, TNWA, TNWB, TPBA, TPWA, TVDA, XQDA

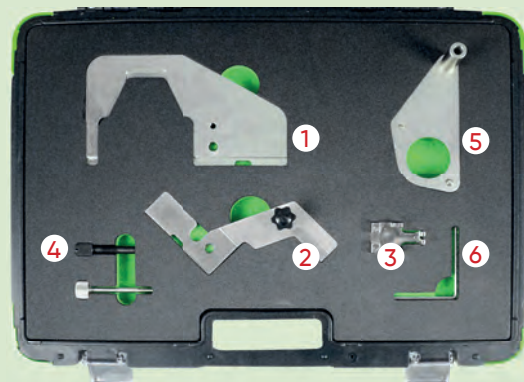

53324

12,50€

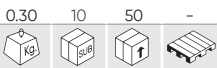

FORD ENGINE TIMING TOOL

APPLICATIONS	FORD: B-MAX (15-17), C-MAX (07-10), COUGAR (98-01), FIESTA (95-17), FOCUS (98-11), FOCUS C-MAX (03-07), FUSION (02-12), GALAXY (06-15), MAVERICK (01-07), MONDEO (93-15), PUMA (97-02), S-MAX (06-15), TOURNEO CONNECT (02-06), TRANSIT (06-12), TRANSIT CONNECT (02-06). MAZDA: 121 ZG (95-00), 2 DY (02-07), 3 BK (03-09), 3 BL (09-15), 5 CR (05-10), 5 CW (10-12), 6 GG/GY (02-07), 6 GH (07-15), MPV LW (02-05), MX-5 NC (05-16), TRIBUTE EP (04-06). VOLVO: C30 (06-13), S40 (06-12), S80 (07-11), V50 (04-12).
OEM TOOLS	FORD: 303-1054, 303-507 (21-210), 303-620 (21-163), 303-574, 303-748, 303-376 (21-162B), 303-376B MAZDA: 49 JE01 061, 303-574, 49 JE02 061, 303-465, 49 JE01 054 VOLVO: 999 7152, 999 7151.
ENGINE CODES	1.4 / 1.6

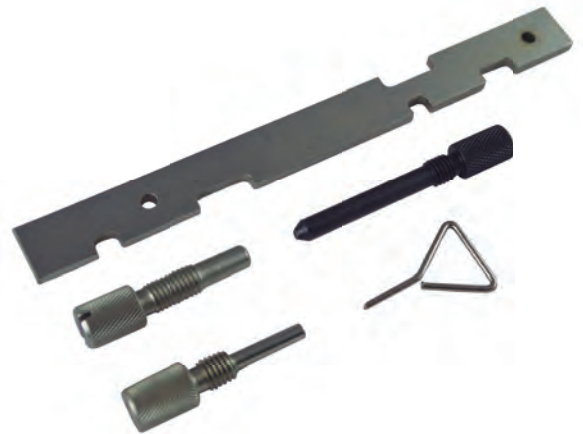

53653

207,00€

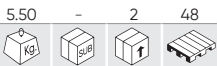

FORD ENGINE TIMING TOOL SET

APPLICATIONS	FORD: FIESTA, FOCUS, B-MAX, ECOSPORT.
OEM TOOLS	303-1605 (1), 303-1606 (2), 303-1604 (3), 303-1602 / 503-393A / (21-168) (4), 303-1054 (5), 303-732 (6)
ENGINE CODES	M1DD, M1JA, M1JC, M1JE, M1JHM1JJ, M1DA, M2DA, M2DB, M2DC, SFDBSFJA, SFJB, SFJC, SFJD

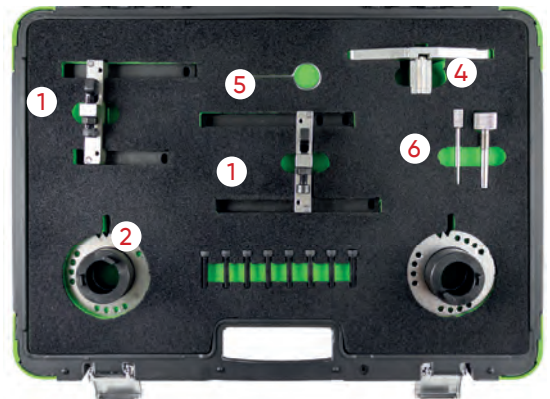

54201

37,60€

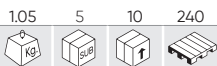

ENGINE TIMING TOOL SET FORD

APPLICATIONS	FORD: C-MAX(07 - 10), C-MAX/GRAND C-MAX(10-18), FIESTA(08-18), FOCUS/FOCUS C-MAX(04-11), FOCUS(11-18), MONDEO(07-15)
OEM TOOLS	303-1097 (1), OEM 303-1054 (2), OEM 303-1059, 303-1270, 0188X, 999-7121 (3), OEM 303-748, 999-7152, 21-259 (4), OEM 303-735, 999 7122, 0187B, 0189B, 0132AJ1, 21-263, 0188M, MOT 1430, 303-1277, 0194B (5)
ENGINE CODES	11.6 TI-VCT HXDA (2003-2007) ,2.0 TDCI , G6DA, G6DB, G6DC 2003-2007



54204

124,00€

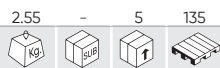

ENGINE TIMING TOOL SET FOR FORD 2.0 ECOBLUE

APPLICATIONS	FORD EDGE, FOCUS, GALAXY, S-MAX (FROM 2018); KUGA, MONDEO, RANGER (DESDE 2019); TRANSIT, TRANSIT CUSTOM AND TOURNEO CUSTOM (DESDE 2016); TODOS CON MOTOR ECOBLUE TDCI ; AWD, FWD Y RWD.
OEM TOOLS	303-1637 (1), 303-1650 (2), 303-1643 (3).
ENGINE CODES	BCCC,YLCB,YLDA,YLF6,YLFA,YLFB,YLFS,YLR6,YLRA,YMCB,YM-F6,YMFA,YMFB,YMFS,YMHA,YMRA,YNCA,YNF6,YNFA,YNFB,YNFS,Y-NR6,YNRA

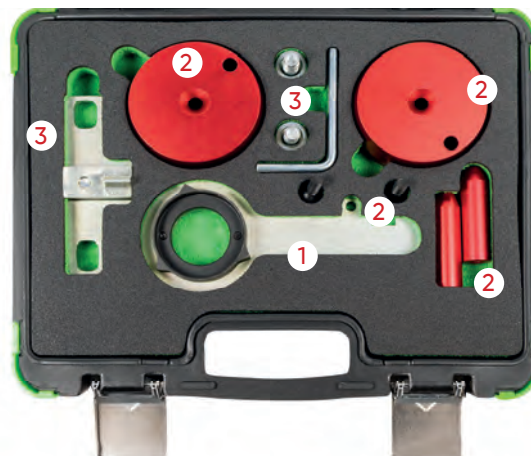

54208

76,00€

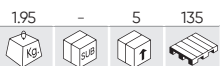

ENGINE TIMING TOOL SET FOR FORD 2.0 ECO BOOST SCTI, TI-VCT

APPLICATIONS	FORD: GALAXY(2010)MONDEO (2010) S MAX (2010) FOCUS(2011)
OEM TOOLS	303-748 (1), 303-1504 (2), 303-1565 (3), 303-1521 (4)
ENGINE CODES	TNWA, TNWB, TPWA, TNBA, TPBA, MGDA, XQDA

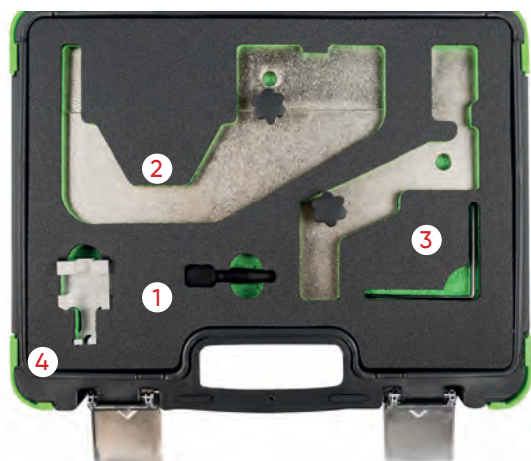

54209

29,70€

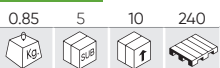

ENGINE TIMING TOOL KIT FOR FORD/MAZDA 2.2, 3.2 TDCI

APPLICATIONS	FORD_RANGER 3.2L (2011-2016) FORD_RANGER 2.2L (2011-2015) FORD_TRANSIT 2.2L (2006-2016) FORD_EVEREST 3.2L (2015) FORD_RANGER 3.2L (2011) MAZDA BT-50 (2011) MAZDA BT-50 3.2L (2011-2016)
OEM TOOLS	303-675/21-234,303-698/21-251 (1), 303-1587 (2)
ENGINE CODES	CYFA,CYFB,DRFA,DRFB,P8FA,P8FB,PGFA,PGFB,QVFA,QWFA,SR-FA,SRFB,SRFC,SRFD,SEFE,UHFA,CYFC,DRFC,USRA

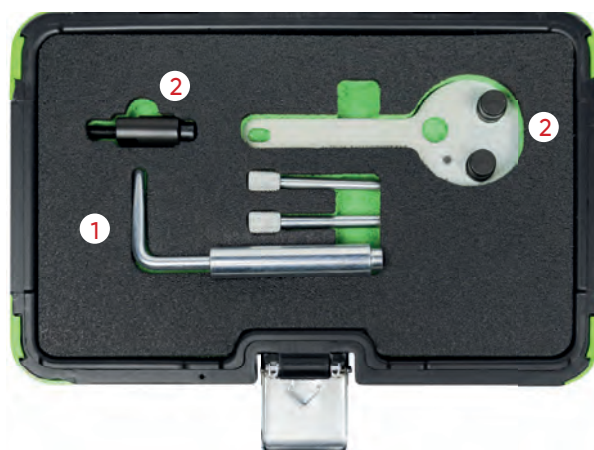

54223

149,00€

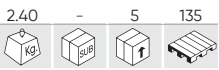

ENGINE CAMSHAFT SPROCKET LOCKING TOOL FOR FORD 1.5T

APPLICATIONS	FORD_1,5L DURATEC, ECOSPORT, FIESTA, FOCUS
OEM TOOLS	303-1639 (1), 303-1643 (2), 303-1647 (3), 303-1648 (4)
ENGINE CODES	2.2 / 2.5

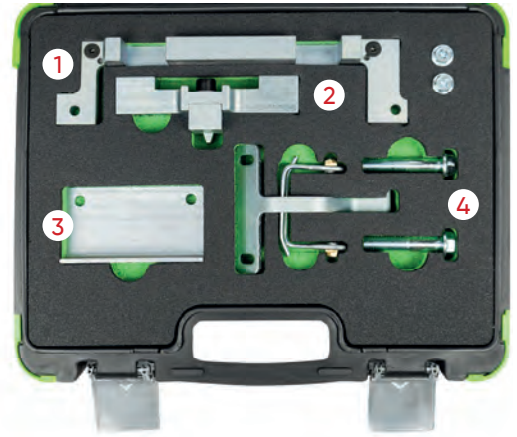

54224

64,50€

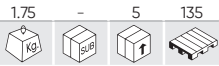

INJECTION PUMP REMOVER/ INSTALLER SET FOR FORD 2.0

APPLICATIONS	FORD: TRANSIT (17-18), TOURNEO CUSTOM (16-18), TRANSIT CUSTOM (16-18)
OEM TOOLS	303-1635 (1)/3, 3.3--1635 (2)/1, 303-1635 (3)/2, 303-1635/6 (4)
ENGINE CODES	YLFS, YMFS, YNFS, YLF6, YMF6, YNF6, YLR6, YMR6 AND YNRS.

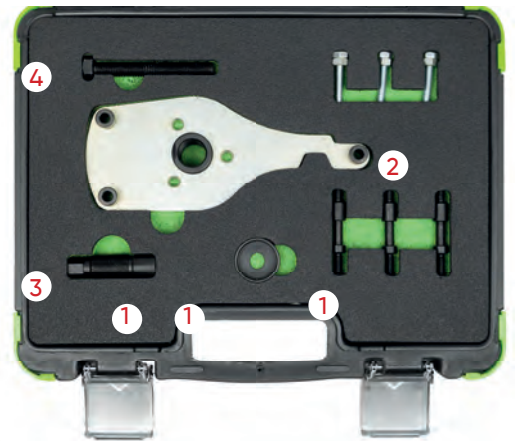

54260

277,00€

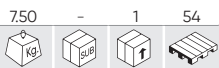

5:1 TORQUE MULTIPLIER SET FOR FORD ECOBOOST ENGINES

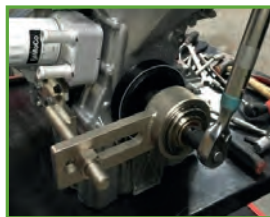

1.0 EcoBoost 2.0 Durator-TDCi
 1.0 Duratec 2.0 EcoBlue Diesel
 2.0 Duratec



53297

45,00€

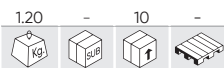

ENGINE TOOL SET JAGUAR/LAND ROVER

APPLICATIONS	JAGUAR: MS TYPETDVI. LAND ROVER: DISCOVERY 2.7 TDV6. RANGE ROVER: SPORT 2.7 TDV6.
OEM TOOLS	303-1117 (1), 303-1116 (2), 303-1132 (3), 303-1126 (4) (5)
ENGINE CODES	276DT, 306DT.

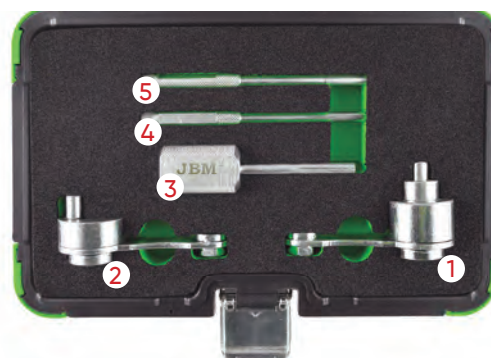

53298

91,00€

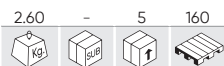

ENGINE TIMING TOOL SET FOR LAND ROVER

APPLICATIONS	DIESEL ENGINES: 200 TDI. 300 TDI. 2.5
--------------	---------------------------------------

- New EDC Manual Transmission Timing Pin.
- 200 TDI, 300 TDI. 2.5 Diesel Engines.
- Crankshaft Damper Puller.
- Injection Pump Gear Locking Tool.
- Injection Pump Timing Pin 200 / 300 TDI.
- Flywheel Timing Tool 200 / 300 TDI.
- DPS Pump Timing Tool 2.5.
- Flywheel Timing Tool 2.5.
- EDC Timing Pin-30Q manual gearbox.



54422

140,00€



BALANCE AXLE ADJUSTMENT KIT JAGUAR/LAND ROVER 2.0D

APPLICATIONS	JAGUAR: E-PACE D150, D180, D240 (X540) (2017-), F-PACE 20D, 25D, E-PERFORMANCE (X761) (2016-), XE 20D, 25D, E-PERFORMANCE (X760) (2015-), XF 20D, 25D, E-PERFORMANCE (X260) (2015-) LAND ROVER: DEFENDER SD4 D200, SD4 D240 (L663) (2019-2021), DISCOVERY SPORT ED4, SD4, TD4, D150, D180, D240 MHEV (L550) (2015-), DISCOVERY SD4, TD4 (L462) (2017-2021) RANGE ROVER: EVOQUE ED4, SD4, TD4 (L538) (2015-2019), EVOQUE D150, D180, D240 MHEV (L551) (2019-), SPORT SD4 (L494) (2016-2018), VELAR D180, D240 (L560) (2017-)
OEM TOOLS	JLR-303-1662 (1) JLR303-1663-1 (2) JLR303-1663-2 (3) JLR303-1663-3 (4) JLR-303-1664 (5) JLR-303-1665 (6)
ENGINE CODES	2.0: AJ200D,AJ200/204DTA,AJ200/2004DTD 2.0: AJ-200D/204DT, AJ-200D/204DTA



54423

108,00€



N

ENGINE TIMING TOOL SET LAND ROVER 3.6D

APPLICATIONS	RANGE ROVER SPORT; 3.6 (TDV8) DIESEL (2006-2011) RANGE ROVER; 3.6 (TDV8) DIESEL (2006-2011)
OEM TOOLS	303-1236 (1) 303-1243 (2) 303-1239 (3) 303-1238 (4)
ENGINE CODES	368DT

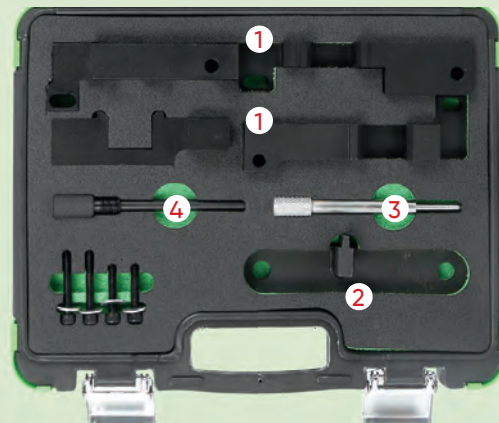

54425

124,00€



N

ENGINE TIMING TOOL SET LAND ROVER FREELANDER V6/ROVER KV6 2.0L, 2.5L

APPLICATIONS	LAND ROVER; FREELANDER (2000-2006) MG; ZR (2004-2005), ZS (2001-2005), ZT (2001-2005) ROVER; 45 (1999-2005), 75 (1999-2005), 825 (1996-1999)
OEM TOOLS	LRT 12-175 (1) LRT 12-187 (2) LRT 12-195 (3) LRT 12-196 (4) LRT 12-198 (5) LRT 12-232 (6)
ENGINE CODES	LAND ROVER; 2,5 KV6 MG; 2,0 KV6, 2,5 KV6 ROVER; 2,0 KV6 2,5 KV6

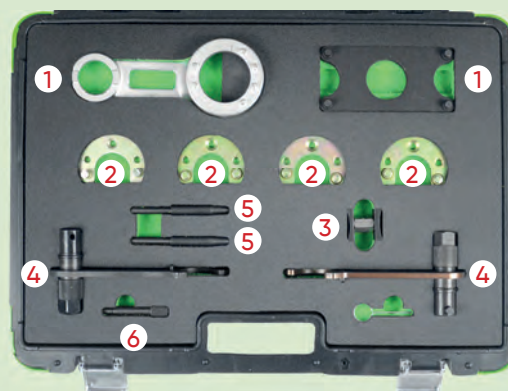

54426

69,00€



N

ENGINE TIMING TOOLS SET JAGUAR/LAND ROVER 3.2, 3.5, 4.0, 4.2, 4.4

APPLICATIONS	DAIMLER; V8 (97-03), SUPER V8 (97-03), SUPER EIGHT (05-10). JAGUAR; S-TYPE (99-08), XF (08-09), XJR (97-10), XJ8 (97-10), XKR (98-09), XK8 (96-09) LAND ROVER; DISCOVERY III (04-09) RANGE ROVER (05-09), RANGE ROVER SPORT (05-09)
OEM TOOLS	303530 (1) 303531 (2) 303532 (3) 303533 (4) 303645 (5) 303654 (6) T40011 (7)
ENGINE CODES	3.2: AC,KB,KC 3.5: RB 4.0: BC, CC,CE,DC,EC,GB,GC,LB,LC,MA,MB,NB,NC,PA,PB 4.2: 1B,2B,3B,1G,5G,9G,HB,HG,SB,TB,PC,428PS 4.4: 448PN

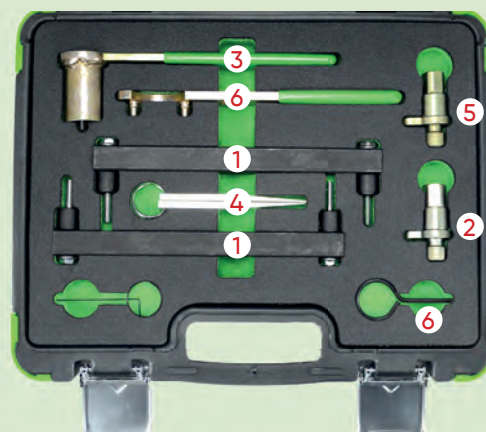

54427

113,00€

5.00 - 2 48



N

CRANKSHAFT PULLEY LOCKING TOOL JAGUAR/LAND ROVER 4.0, 4.2, 4.4

APPLICATIONS	DAIMLER: V8; 4.0 (97-98) JAGUAR: S-TYPE; 3.2, 3.5, 4.2 V8 (99-08), XF; 3.2, 3.5, 4.2 V8 (08-09), XJ; 3.2, 3.5, 4.2 V8 (97-08), XJ8; 4.0 (97-98), XK; 3.2, 3.5, 4.2 V8 (97-08), XK8; 4.0 (97-98) LAND ROVER: DISCOVERY3; 4.2, 4.4 LA V8 (05-09) RANGE ROVER; 4.2, 4.4 SPORT LS V8 (05-09), RANGE ROVER; 4.2, 4.4 LM V8 (06-08)
OEM TOOLS	LRT 12 080 18G 1437 18G 1437 2 303 191 303 191 03 303 191 04 303 588 303 893
ENGINE CODES	AJ26, AJ27, AJ28, AJ34 30G,36D,42D,56D,58D,94D,428PS,448PN



54428

31,00€

1.10 5 10 240



N

ENGINE TIMING TOOL SET CHRYSLER/JEEP 2.8 CRD

APPLICATIONS	CHRYSLER GRAND VOYAGER 2008 - 2015 DODGE NITRO 2007 - 2011 JEEP CHEROKEE 2008 - 2013, WRANGLER 2007 - 2018
OEM TOOLS	VM 9991 (1) VM 9992 (2)
ENGINE CODES	VM64C, ENS, ENS (51C), 49C, 50C, ENS VM10D, ENS VM11D



54429

55,00€

2.50 - 5 135



N

ENGINE TIMING TOOL SET CHRYSLER/JEEP 3.0D

APPLICATIONS	CHRYSLER 300 C 2012 - 2015 JEEP GRAND CHEROKEE 2011 - ON
OEM TOOLS	VM 10338 1 (1) VM 10338 2 (2) VM 10359A (3), VM 10359 (3) VM 10339 (4), VM 10359 (4)
ENGINE CODES	3.0 CRD: EXF 3.0 CRD/MULTIJET: EXF VM23D, EXF VM44D, EXF VM44D, EXF VM63D

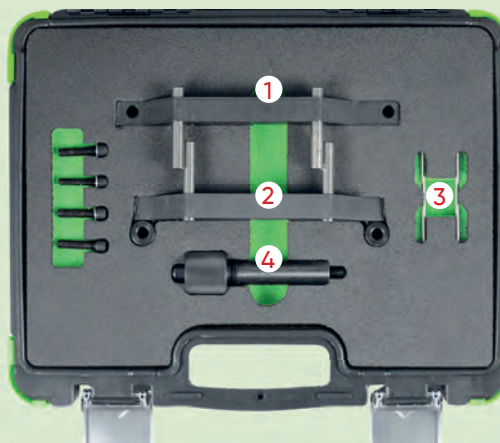

54207

38,90€

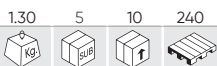

ENGINE TIMING TOOL SET FOR CHRYSLER/JEEP LDV 2.5 CRD

APPLICATIONS	CHRYSLER: VOYAGER (01-08), GRAND VOYAGER (01-08) JEEP: CHEROKEE (01-08) LDV: MAXUS (05-09)	
OEM TOOLS	VM 9660 (1), VM1052 (2), VM1053 (3), VM1068 / VM1089 (4), VM1080 (5), VM8873 (6)	
ENGINE CODES	2.5D CRD: R2516C, R2516K, R2516LVM39/40B.	2.8D CRD: R2816C5.05A, R2816K4.



53270

70,00€

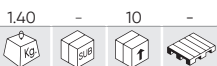

ENGINE TIMING TOOL KIT MERCEDES/CHRYSLER/JEEP

APPLICATIONS	MERCEDES CHRYSLER JEEP
OEM TOOLS	112589034000 (1), 601589024000 (2), 111589031500 (3)
ENGINE CODES	HERR.: 112 589 03 40 00; 112, 113, 137, 155, 156, 272/979, 273, 629, 642/992. HERR.: 601 589 02 40 00: 102, 103, 104, 111, 601, 602.91/93/94/96/983, 603.91/93/96/97, 604, 605, 606, 611, 612/965/966, 613. HERR.: 111 589 03 15 00: 111, 119, 604, 605, 606, 611/980, 612, 613, 628, 629, 640, 642/922, 612.965/966, 646, 647, 648.

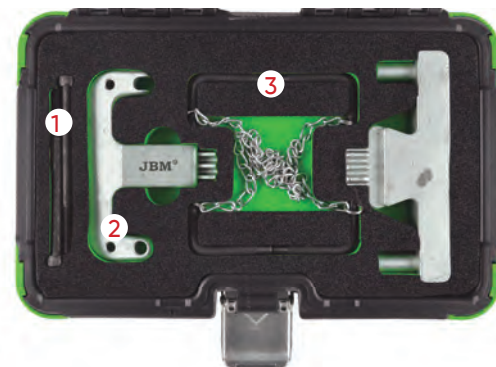

53271

227,00€



ALIGNMENT TOOL SET FOR MERCEDES BENZ M271

APPLICATIONS	MERCEDES
OEM TOOLS	271 589 003100 (1), 271589014000 (2), 271589001500 (3), 156589006100 (4)
ENGINE CODES	M271. E18ML 2002. DE18ML 2003 - 2005. E16ML 2008. DE18LA 2009.

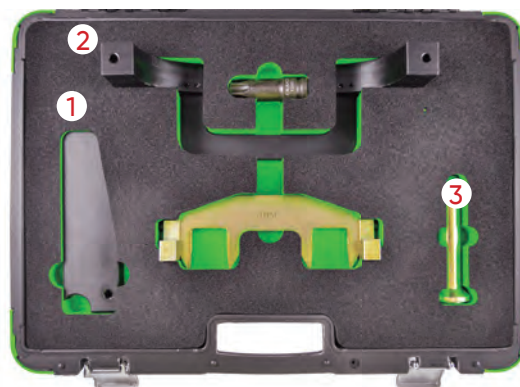

53272

195,00€



MERCEDES BENZ AMG 156 TIMING TOOL KIT

APPLICATIONS	MERCEDES
OEM TOOLS	156589006100 (1), 156589003200 (2), 156589016300 (3), 156589006900 (4)
ENGINE CODES	BENZ AMG 156.ML 63 AMG.S 63L AMG.S 63. AMG. R 63 AMG L 4MATIC. R63 AMG 4MATIC. E 63 AMG. CLS 63 AMG. CLK 63 AMG BLACK SERIES. CLK 63 AMG CABRIO. CL 63 AMG.

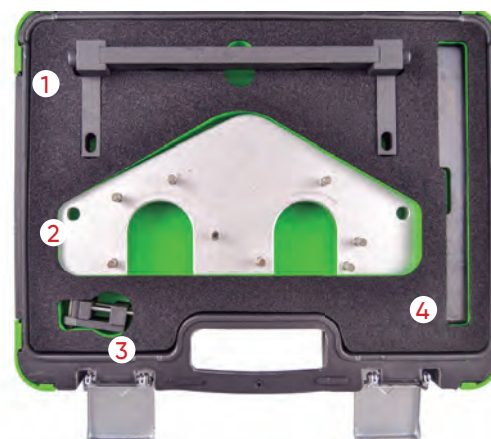

53273

75,00€



ENGINE TIMING TOOL FOR MERCEDES M276, M157, M278

APPLICATIONS	MERCEDES		
OEM TOOLS	27658901400		
ENGINE CODES	<table border="0"> <tr> <td>CL 500 / 63 AMG (C 216) 2010–2013. S 500 / 63 AMG (C 217) 2014. CLS 300 (C 218) 2012. E 300 / 350 / 400 (C/A 207) 2011. CLS 350 / 400 / 500 / 63 AMG (C/X 218) 2011–2014. SLK 350 (R 172) 2011. SL 350 / 400 / 500 / 63 AMG (R 231) 2012. S 500 PLUG-IN HYBRID (V 222) 2014. ML 300 / 350 / 500 / 63 AMG (W 166) 2011.</td> <td>C 400 (W 205) 2014. E 400 HYBRID (W 212) 2012. G 63 AMG (W 463) 2012. E 300 / 350 / 400 / 500 / 63 AMG (W/S 212) 2011. C 350 (W/S/C 204) 2011. S 350 / 500 / 63 AMG (W/V 221) 2010. S 400 / 63 AMG (W/V 222) 2013. R 350 BlueEFFICIENCY (W/V 251) 2012. GL 450 / 500 (X 166) 2012. GLK 350 (X 204) 2011.</td> </tr> </table>	CL 500 / 63 AMG (C 216) 2010–2013. S 500 / 63 AMG (C 217) 2014. CLS 300 (C 218) 2012. E 300 / 350 / 400 (C/A 207) 2011. CLS 350 / 400 / 500 / 63 AMG (C/X 218) 2011–2014. SLK 350 (R 172) 2011. SL 350 / 400 / 500 / 63 AMG (R 231) 2012. S 500 PLUG-IN HYBRID (V 222) 2014. ML 300 / 350 / 500 / 63 AMG (W 166) 2011.	C 400 (W 205) 2014. E 400 HYBRID (W 212) 2012. G 63 AMG (W 463) 2012. E 300 / 350 / 400 / 500 / 63 AMG (W/S 212) 2011. C 350 (W/S/C 204) 2011. S 350 / 500 / 63 AMG (W/V 221) 2010. S 400 / 63 AMG (W/V 222) 2013. R 350 BlueEFFICIENCY (W/V 251) 2012. GL 450 / 500 (X 166) 2012. GLK 350 (X 204) 2011.
CL 500 / 63 AMG (C 216) 2010–2013. S 500 / 63 AMG (C 217) 2014. CLS 300 (C 218) 2012. E 300 / 350 / 400 (C/A 207) 2011. CLS 350 / 400 / 500 / 63 AMG (C/X 218) 2011–2014. SLK 350 (R 172) 2011. SL 350 / 400 / 500 / 63 AMG (R 231) 2012. S 500 PLUG-IN HYBRID (V 222) 2014. ML 300 / 350 / 500 / 63 AMG (W 166) 2011.	C 400 (W 205) 2014. E 400 HYBRID (W 212) 2012. G 63 AMG (W 463) 2012. E 300 / 350 / 400 / 500 / 63 AMG (W/S 212) 2011. C 350 (W/S/C 204) 2011. S 350 / 500 / 63 AMG (W/V 221) 2010. S 400 / 63 AMG (W/V 222) 2013. R 350 BlueEFFICIENCY (W/V 251) 2012. GL 450 / 500 (X 166) 2012. GLK 350 (X 204) 2011.		



54318

105,00€

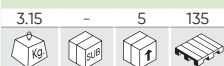

TIMING CHAIN RIVETING TOOL

APPLICATIONS	CHRYSLER JEEP MERCEDES
OEM TOOLS	112 589 026 300 (1) 103 589 016 300 (2) 602 589 026 300 (3) 602589023300 (4) 602589003900 (5) 602589046301 (6)
ENGINE CODES	CHRYSLER/JEEP: 2.2D, 2.7D, 3.0D CRD (DIESEL). MERCEDES: 1.7D, 2.1D, 2.2D, 2.7D, 3.0D, 3.2D, 3.9D, 4.0D CDI (DIESEL)

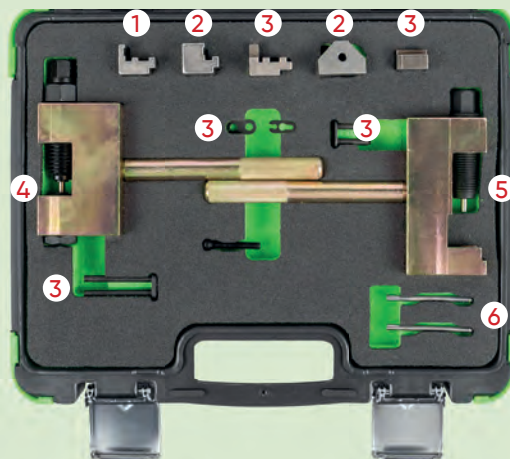

54414

97,50€

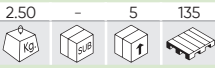

N

ENGINE TIMING TOOL SET MERCEDES M651

APPLICATIONS	A CLASS (2012-2018), B CLASS (2012-2019), C CLASS (2009-2015), C CLASS (2014-2018), CLA COUPE (2013-2019), CLS (2011-2018), E CLASS (2009-2016), GLA (2014-2020), GLC (2015-2019), GLE (2015-2019), GLK (2008-2015), M CLASS (2011-2015), S CLASS (2010-2013), S CLASS (2013-2017), SLC (2016-2017), SLK (2012-2016), SPRINTER (2009-2018), SPRINTER (2018-), V CLASS (2014-), VIANO (2010-2015), VITO (2010-2015), VITO (2014-) MERCEDES-BENZ
OEM TOOLS	608 31 800 (1) 608 31 830 (2) 608 31 810 (3) 608 31 820 (4) 651 589 00 40 00 (5)
ENGINE CODES	1.8: 651.901 2.1: 651.900, 651.910, 651.911, 651.912, 651.913, 651.916, 651.921, 651.922, 651.924, 651.930, 651.940, 651.950, 651.955, 651.956, 651.957, 651.958, 651.960, 651.961, 651.980 2.2: 651.925

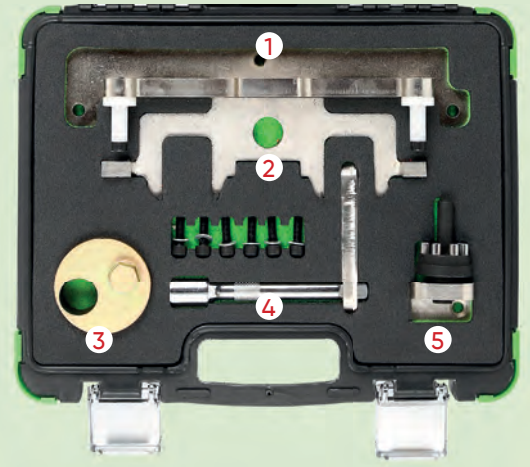

54415

60,00€

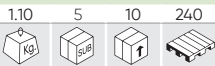

N

ENGINE TIMING TOOL SET MERCEDES M651

APPLICATIONS	GLA X156 200/220 CDI, GLK X 204 200/220/250 CDI, ML W166 250, SLK R172 250 CDI, SPRINTER W906 210/310/510/213/313 CDI, SPRINTER W906 513/216/316/416/516 CDI, V-CLASS W/V 639 2.0/2.2 CDI, VITO W/V 639 110/113/116 CDI MERCEDES-BENZ: A-CLASS W176 180/200/220 CDI, B-CLASS W246 200/220 CDI, C-CLASS W/S/C 204 180/200/220/250 CDI, CLA C117 200/220 CDI, CLD C/X 218 220/250, E-CLASS W/S 212 200/220/250 CDI E-CLASS C/A 207 220/250 CDI, E-CLASS W212 250/300 BLUETEC
OEM TOOLS	651589004000 (1) 651589014000 (2)
ENGINE CODES	1,8 651.901 2,1 651.900 651.910 651.911 651.912 651.913 651.916 651.921 651.922 651.924 651.925 651.930 651.940 651.950 651.955 651.956 651.957 651.958 651.960 651.961 651.980



54416

31,00€

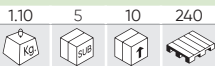

N

ENGINE TIMING TOOL SET MERCEDES M651

APPLICATIONS	G-CLASS (461/463) 2007-2015, GL-CLASS (164/166) 2006-2016, GLE/GLE COUPE (166/292) 2020 GLK (204) 2008-2015, GLS (166) 2016-2019, M-CLASS (164/166) 2005-2015, R-CLASS (251) 2005-2013, S-CLASS (221/222) 2005-2017, SPRINTER (906) 2006-2018, VIANO (639) 2005-2015, VITO (639) 2006-2015 MERCEDES-BENZ: C-CLASS (203/204) 2004-2014, CLK (209) 2005-2009, CLS (219/218) 2005-2018, E-CLASS (211/212/213) 2005-2018, E-CLASS COUPE/CABRIOLET (207) 2009-2017
OEM TOOLS	642589003100 (1)
ENGINE CODES	642.820 642.822 642.826 642.830 642.832 642.834 642.835 642.836 642.838 642.850 642.852 642.853 642.854 642.855 642.856 642.858 642.861 642.862 642.867 642.868 642.870 642.872 642.884 642.886 642.890 642.896 642.910 642.920 642.921 642.922 642.930 642.932 642.940 642.950 642.960 642.961 642.970 642.975 642.990 642.992 642.993

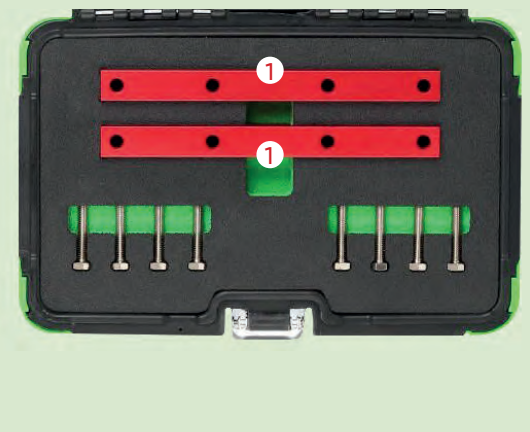

54417

153,00€



N

ENGINE TIMING TOOL SET MERCEDES M133, M270, M274

APPLICATIONS	MERCEDES BENZ A -CLASS (W176) (2012), MODEL A180/A200 MERCEDES BENZ B CLASS (W246) AS OF 2011, MODEL B180/B200
OEM TOOLS	270589006100 (1)
ENGINE CODES	M133 M270 M274

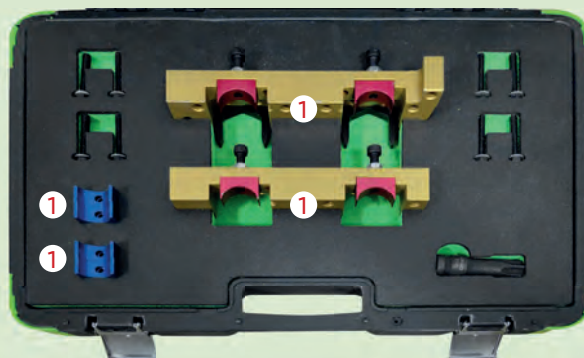

54418

37,00€



N

ENGINE TIMING TOOL SET MERCEDES M112, M113

APPLICATIONS	C-CLASS (202) 2.4/2.6/2.8/3.2/4.3 - 1998-00, CLK (208) 3.2/4.3/5.4 - 1997-03, E-CLASS (210) 2.4/3
OEM TOOLS	112589003200 (1) 112589013200 (2) 112589000100 (3)
ENGINE CODES	MERCEDES.BENZ: M112, M113

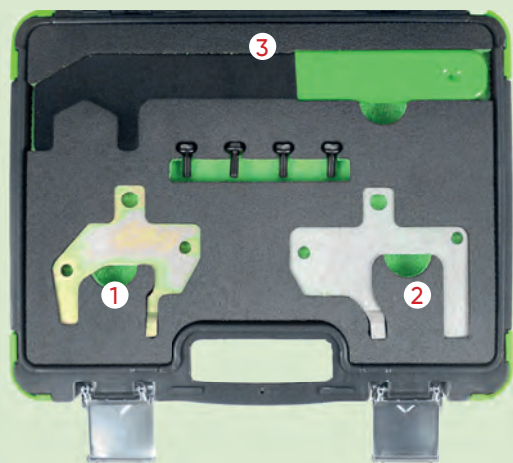

51488

16,00€



DIESEL AND GASOLINE ENGINE TIMING PINS SET FOR RENAULT/NISSAN/DACIA/SUZUKI

APPLICATIONS	RENAULT: CAPTUR, CLIO II,III,IV, ESPACE/GRAND ESPACE III,IV, FLUENCE, KADJAR, KANGOO, LAGUNA I,II,III, LOGAN/ LOGAN MCV, MEGANE I,II,III,IV, MODUS/GRAND MODUS, SCENIC/ GRAND SCENIC I,II,III,IV, TWING II, TRAFIC II, MASTER II 1.5DCI & 1.9 DCI. DACIA: DOKKER, DUSTER, LODGY, LOGAN, SANDERO 1.5DCI NISSAN: ALMERA, CUBE, JUKE, KUBISTAR, MICRA, NOTE, NV200/EVALIA, PRIMERA, TIIDA, INTERSTAR, PRIMASTAR 1.5DCI & 1.9 DCI SUZUKI: GRAND VITARA, JIMNY 1.5DDIS & 1.9DDIS
OEM TOOLS	MOT1489, MOT1430, MOT1054.
ENGINE CODES	K9K, F8Q, F9Q - Petrol, Clío, R19, Laguna 1.8/2.0 F3R F3P



53289

45,00€

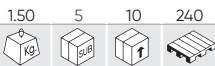

PETROL ENGINE TIMING KIT RENAULT 1.4, 1.6, 1.8, 2.0 16V

APPLICATIONS	<p>RENAULT: ESPACE/GRAND ESPACE (98-02), ESPACE/GRAND ESPACE IV (02-10), KANGOO/TREKKA (01-09), LAGUNA (98-01), LAGUNA II (01-07), LAGUNA III (07-13), MEGANE (99-03), MEGANE II (02-10), MEGANE III/SPORT (08-13), MEGANE/SCENIC (99-00), SCENIC/RX4 (99-03), SCENIC/GRAND SCENIC II (03-09), TRAFIC II (01-11), TWINGO II (08-14), VEL SATIS (00-10), WIND (10-14)</p> <p>DACIA: LOGAN/MCV (05-11).</p> <p>NISSAN: KUBISTAR X76 (03-09), PRIMASTAR (02-11).</p> <p>VAUXHALL/OPEL: JETTA, TOURAN, GOLF, GOLF PLUS, POLO, PASSAT, TIGUAN, SCIROCCO.</p>
OEM TOOLS	MOT1489 (1), MOT1054 (2), MOT1496 (3)
ENGINE CODES	<p>1.4 16V K4J: 730, 732, 740.</p> <p>1.6 16V K4M: 752, 753, 760, 761, 764, 788, 812, 813, 854, 856.</p> <p>1.8 16V F4P: 720, 722, 760, 770, 771, 772, 773, 774, 775.</p> <p>2.0 16V F4R: 700, 701, 712, 713, 714, 715, 720, 722, 730, 732, 736, 738, 740, 741, 744, 746, 747, 762, 763, 764, 765, 766, 767, 770, 771, 780, 790, 791, 792, 820, 830, 832, 867.</p> <p>2.0 16V F4R(TT): 720, 722, 764, 765, 774, 776, 784, 786, 787, 794, 795, 796, 797, 800, 802, 810, 811, 870, 872, 874, 886, 887, 896, 897.</p>

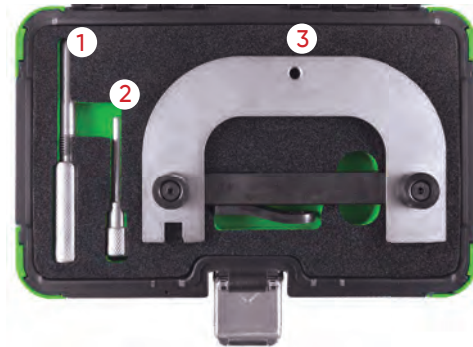

53290

51,00€

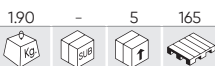

ENGINE TIMING TOOL SET FOR RENAULT/VOLVO 16V, 20V

APPLICATIONS	<p>RENAULT: LAGUNA 2.0 16V / 2.5 20V (1996-1999), SAFRANE 2.0 16V / 2.5 20V (1996-2001)</p> <p>VOLVO: 850 (1992-1997), C70 (1998-2002), S40 (1996-2004), V40 (1996-2004), S60 (2001-2005), S70 (1997-2000), S80 (1999-2005).</p>
OEM TOOLS	MOT1348 (1), MOT1337 (2), MOT1340 (3)
ENGINE CODES	<p>RENAULT: N7Q 704/710/711(2.0 16V), N7U 700/701(2.5 20V).</p> <p>VOLVO: B4164S, B4164S2, B4184S, B4184S2, B4184S3, B4184S9, B4184S10, B4194T, BS194T2, B420S4, B4204S2, B4204T, B4204T2, B4204T3, B4204T5, B5202FS, B5204FT, B5204T2, B5204T3, B5204T4, B5204T5, B5234FS, B5204FT, B5234T3, B5234T4, B5234T5, B5234T6, B5234T7, B5234T8, B5234T9, B5244S, B5244S2, B5244SG, B5244SG2, B5244T, B5244T3, B5244T4, B5244T5, B5244T7.</p>

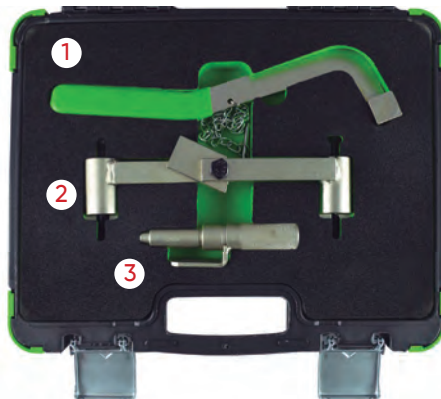

53291

68,00€



ENGINE TIMING TOOL SET RENAULT

APPLICATIONS	RENAULT: CLIO, LAGUNA, MEGANE
OEM TOOLS	MOT1496 (1), MOT1489 (2), MOT861/1863 (3), MOT1490(4)
ENGINE CODES	K4J, K4M, F4P, F4R.

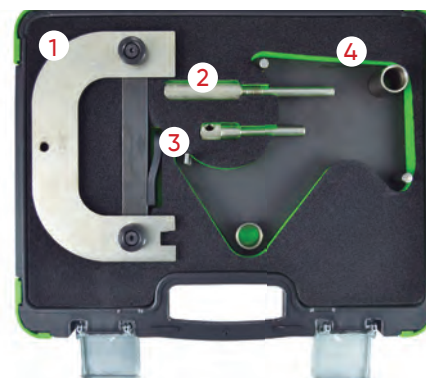

53292

116,00€



ENGINE TIMING TOOL SET RENAULT/OPEL 2.2, 2.5 TDI DCI

APPLICATIONS	RENAULT: LAGUNA II, ESPACE, MASTER, TRAFIC, 2.2 / 2.5 DCI OPEL: VIVARO, MOVANO, DIESEL: 2.2 / 2.5 DTI, ASTRA B, VECTRA B, SIGNUM, ZAFIRA, 2.2 16V
OEM TOOLS	KM6205 (1), KM6204 (2), KM6077 (3)
ENGINE CODES	2.2 / 2.5

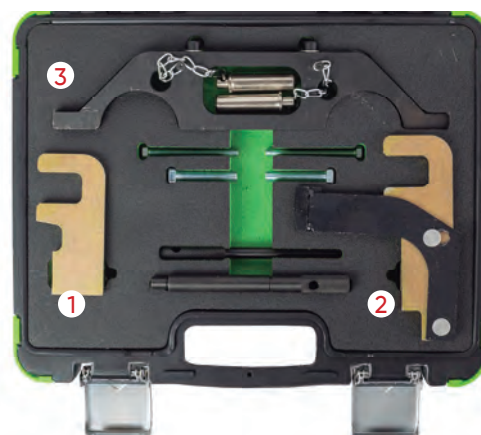

53311

97,00€



ENGINE TIMING TOOL SET RENAULT/NISSAN/OPEL/VAUXHALL 2.0, 2.3 DCI, CDTI, M9R, M9T

APPLICATIONS	NISSAN: PRIMASTAR X83 (06-15), QASHQAI/QASHQAI+2 J10 (07-14), X-TRAIL T31 (07-14). VAUXHALL/OPEL: MOVANO-B (10-17), VIVARO (06-15). RENAULT: ESPACE/GRAND ESPACE IV (06-10), KOLEOS (08-15), LAGUNA LL (05-07), LAGUNA LLL (07-14), MASTER LLL (10-15), MEGANE LL (06-10), SCENIC/GRAND SCENIC LL (06-09), SCENIC/GRAND SCENIC LLL (09-15), TRAFIC LL (06-14), VEL SATIS (05-10)
OEM TOOLS	MOT1769 (1), EN-48334 (2), MOT1766 (3), EN-48330 (3), KM-6130 (4), EN-48332 (5), MOT1773 (6), EN-48831 (6)
ENGINE CODES	2.0D DCI M9R: 630, 780, 782, 784, 786, 788, 830, 832, 833, 834, 835, 836, 838, 855, 856. 2.0D CDTI M9R: 630, 780, 782, 784, 786. 2.3 BI-CDTI: LP6/M9T706, LW7/M9T706. 2.3D DCI M9T: 670, 672, 676, 678, 680, 686, 690, 692, 694, 698.



53523

91,00€



DIESEL ENGINE LOCKING KIT RENAULT/NISSAN/OPEL 1.6 DCI

APPLICATIONS	RENAULT: ESPACE/GRAND ESPACE IV (06-10), KALEOS (08-11), LAGUNA LL (05-07), LAGUNA LLL (07-12), MASTER LLL (10-12), MAGANE LL (06-10), SCENIC/GRAND SCENIC LL (06-09), SCENIC/GRAND SCENIC LLL (09-12), TRAFIC LL (06-12), VEL SATIS (05-10) NISSAN: PRIMASTAR X83 (06-10), QASHQAI/QASHQAI+2 J10 (07-10), X-TRAIL T31 (07-12). VAUXHALL / OPEL: MOVANO-B (10-12), VIVARO (06-12).
OEM TOOLS	MOT1969 (1), MOT1970 (2), MOT1770, MOT1773, EN-48330, EN-48332, EN-48334, EN-48831, KM-6130
ENGINE CODES	M9R 2.0DCI: 610, 615, 630, 700, 721, 740, 742, 760, 761, 762, 763, 780, 782, 784, 786, 788, 800, 802, 803, 805, 808, 816, 830, 832, 833. M9T 2.3DCI: 670, 672, 676, 678, 680, 686, 690, 692, 694, 698.



54210

84,00€



ENGINE CAMSHAFT SPROCKET LOCKING TOOL FOR RENAULT 1.8, 2.0 16V

APPLICATIONS	RENAULT LAGUNA II (2001 - 2009), MEGANE II (2002 - 2009), Scenic (2002 - 2009)
OEM TOOLS	MOT 1509-01 (1), 1509 (2)
ENGINE CODES	700, 701, 712, 713, 714, 715, 720, 721, 722, 722, 730, 732, 736, 738, 740, 741, 744, 746, 747, 760, 761, 762, 763, 764, 765, 766, 767, 770, 771, 773, 774, 774, 775, 776, 784, 786, 787, 790, 792, 794, 797, 830, F4P, F4R



54225

133,00€



FLYWHEEL / CRANKSHAFT PULLEY LOCKING SET FOR RENAULT/NISSAN

APPLICATIONS	NISSAN: PRIMASTAR (06-15), QASHQAI/QASHQAI+2 (07-14), X-TRAIL (07-14), NAVARA (15-16), NV400 (11-16) RENAULT: ESPACE V (15-16), CLIO (06-16), FLUENCE (09-15), LAGUNA (05-15), LATITUDE (10-15), MEGANE (06-15), SCENIC/ GRAND SCENIC (06-15), ESPACE/GRAND ESPACE IV (02-15), KOLEOS (08-16), TRAFIC II (07-15), VEL SATIS (00-10), MASTER III (10-16)
OEM TOOLS	MOT 1431(1), MOT 1716(2), MOT 2019(2), MOT 1789(3), MOT 919-02(4)
ENGINE CODES	1.4:H4.JT700 1.6:M5M400, M5M450 2.0:M4R700, M4R701, M4R704, M4R711, M4R713, M4R714, 2.0D:M9R726, M9R730, M9R735, M4R737, M9R740, M4R746, M9R742, M9R744, M9R746, M9R748, M4R750, M4R751, M4R752, M4R753, M4R754, M9R610, M9R613, M95615, M9R630, M9R750, M9R760, M9R761, M9R762, M9R762, M9R763, M9R700, M9R721, M9R722, M9R724, M9R756, M9R780, M9R782, M9R800, M9R802, M9R803, M9R804, M9R805, M9R806, M9R808, M9R809, M9R811, M9R812, M9R814, M9R815, M9R816, M9R817, M9R820, M9R824, M9R828, M9R830, M9R832, M9R833, M9R834, M9R835, M9R836, M9R838, M9R839, M9R844, M9R845, M9R846, M9R849, M9R854, M9R855, M9R856, M9R857, M9R858, M9R859, M9R865, M9R866, M9R784, M9R786, M9R788 2.3D:M9T670, M9T672, M9T676, M9T678, M9T680, M9T686, M9T690, M9T692, M9T694, M9T696, M9T698, M9T700, M9T702, M9T706, M9T708, M9T870, M9T880, M9T890, M9T896, M9T898, M9T899, YS23DDT, YS23DDTT 2.5:2TR700, 2TR702, 2TR703, 2TR704, 2TR705, 2ZV604, V4U604, VQ25 3.5:V4Y701, V4Y711, V4Y713, V4Y715



YOUR TIMING TOOL SET EVEN CLOSER

ENTER THE OEM TOOL CODE OR ENGINE CODE OF YOUR CAR IN YOUR WEB BROWSER AND FIND YOUR COMPATIBLE TIMING TOOL

54289

38,00€

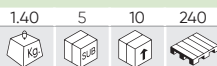

N

FLYWHEEL LOCK KIT FOR MERCEDES/RENAULT/DACIA/NISSAN

APPLICATIONS	DACIA DOKER 2015 + DACIA DUSTER 2015+ DACIA LODGY 2015+ DACIA LOGAN 2013/-2020 DACIA SANDERO 2013+ MERCEDES-BENZ A-CLASS 2018+ MERCEDES-BENZ B-CLASS 2019+ MERCEDES-BENZ CLA 2019+ MERCEDES-BENZ GLA 2019+ MERCEDES-BENZ GLB 2019+ RENAULT ARKANA 2019+ RENAULT CAPTUR 2018+ RENAULT CLIO V 2019 + RENAULT KADJAR 2018+ RENAULT MEGANE IV 2017+ RENAULT SCENIC/GRAND SCENIC IV 2018+ RENAULT TALISMAN 2018+
OEM TOOLS	MOT.2188 (1)
ENGINE CODES	HR13DDT, H4Bt 400, H4Bt 408, H4Bt 410, H4Bt 411, H4M 730, H4M 738, H4M 740, H5H 450, H5H 470, H5H 480, 282.914



54438

40,00€



N

ENGINE TIMING TOOL SET RENAULT/NISSAN 3.0DCI

APPLICATIONS	NISSAN: NAVARA PICK UP, PATHFINDER, INFITI RENAULT: LAGUNA, LATITUDE
OEM TOOLS	MOT 1880 (1) MOT 1970 (2) MOT 1874 (3)
ENGINE CODES	V9X, V9X 791, 891

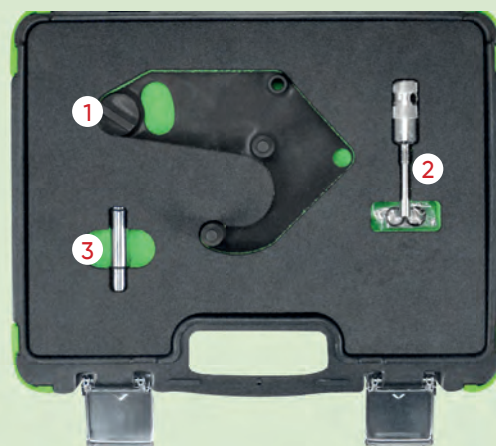

54439

32,50€



N

CRANKSHAFT PULLEY LOCKER RENAULT/DACIA 0.9, 1.0, 1.2, 1.6 TCE

APPLICATIONS	DACIA DOKKER 2012 - 2019, PLUMERO 2013 - 2018, LOGIA 2012 - 2018 RENAULT CAPTURAR 2013 - 2019, CLIO IV 2012 - 2019, KADJAR 2015 - 2018, KANGOO II 2013 - EN, MEGANE III 2012 - 2017, MEGANE IV 2016 - 2020, ESCENICO/GRAN ESCENICO III 2012 - 2017, ESCENICO/GRAN ESCENICO IV 2016 - 2018, TWIN-GO III 2014 - EN
OEM TOOLS	MOT. 2006 (1) MOT. 2054 (1) 281589004000 (1)
ENGINE CODES	0.9TCE: H4B 453, H4Bt 400, 401, 408, 410, 411, 451. 1.0TCE: H4D, H4D 400, 450, 460, 470 1.2TCE: H5Ft 400, 403, 404, 405, 408, 410, 412. 1.6TCE: H4M 429, 438, 440, 729, 730, 738, 740, 748, 749

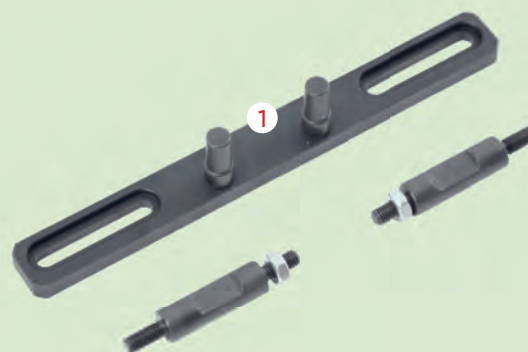

53299

291,00€

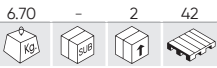

TIMING TOOL KIT FOR OPEL/ VAUXHALL (GM)

APPLICATIONS	OPEL / VAUXHALL
OEM TOOLS	EN-46788 (1), KM927 (2), EN-46789 (3), KM929 (4), EN-46785 (5), EN-46788 (6), 1 860 985 000 (7), KM932 (8), KM933 (9), EN-49978 (10), KM933 (11)
ENGINE CODES	1.3 CDTI 16V, 1.9 CDTI, 2.0 DTI, 2.2 DTI.



53300

41,00€

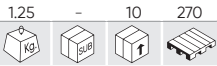

ENGINE TOOL TIMING SET FOR OPEL/VAUXHALL/CHEVROLET 2,0CDI

APPLICATIONS	OPEL VAUXHALL CHEVROLET
OEM TOOLS	EN-48245 (1), EN-48246 (2), 205083060 (3) (4) (5) (6)
ENGINE CODES	OPEL / VAUXHALL: Z20DM, Z20DMH CHEVROLET: LLWZ20DMH, RA 420 , Z20SI, Z 20S3, Z 20S4, Z 20S5

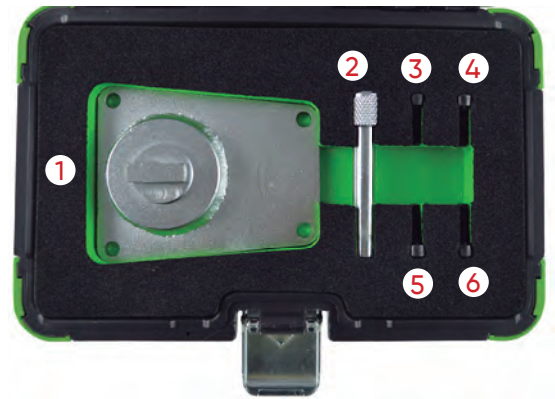

53301

44,00€

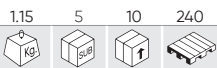

ENGINE TIMING TOOL SET FOR SUZUKI/OPEL 1.0, 1.2, 1.4

APPLICATIONS	SUZUKI: WAGON R (05-08). VAUXHALL / OPEL: AGILA (00-08), ASTRA-G (98-06), ASTRA G CLASSIC II (03-10), ASTRA-H (04-11), COMBO (04-12), CORSA-B (97-00), CORSA-C (00-07), CORSA-D (06-12), MERIVA-A (04-10), TIGRA-B (04-10).
OEM TOOLS	KM-953/09919-58310 (1), KM-952/09912-38310 (2), KM-954/09919-08310 (3), KM-6130 (4), KM-955/09919-58320 (5)
ENGINE CODES	1.0 12V: X10XE, Z10XE, Z10XEP. 1.2 16V: X12XE, Z12XE, Z12XEP. 1.4 16V/ECOFLEX: Z14XEL, Z14XEP.

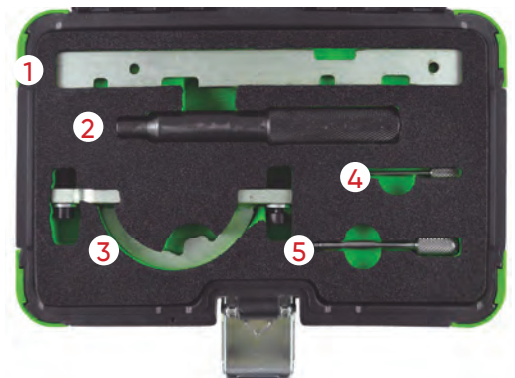

53302

44,00€

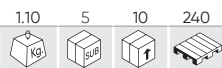

ENGINE TIMING TOOL SET FIAT/ALFA ROMEO/VAUXHALL/OPEL/SAAB JTD

APPLICATIONS	SAAB: 9-3 (04-08), 9-5 (05-08). VAUXHALL / OPEL: ASTRA-H, VECTRA-C, SIGNUM (04-07), ZAFIRA-B (05-07).
OEM TOOLS	EN46789/32 025 008 (1) (3), EN46788/32 025 009 (2), KM6349 (4)
ENGINE CODES	Z19DT, Z19DTH, Z19DTL.



53305

136,00€

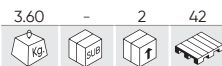

ENGINE TIMING TOOL SET SAAB/OPEL/VAUXHALL

APPLICATIONS	VAUXHALL / OPEL: ANTARA (06-10), CALIBRA (93-98), CAVALIER/VECTRA-A (93-95), OMEGA-B (94-03), SIGNUM (03-05), SINTRA (96-99), VECTRA-B (95-02), VECTRA-C (02-05). SAAB: 900 (93-98), 9000 (95-97), 9-5 (98-03)
OEM TOOLS	KM-800-1 (1), KM-800-2 (2), KM-800-20 (3), KM-800-10 (4), 83 95 006 (5), KM-800-30 (6), MKM-6038, 83 95 006 (7)
ENGINE CODES	2.5 V6: SAAB: B2581, VAUXHALL/OPEL: C25XE, X25XE. 2.6 V6: VAUXHALL/OPEL: Y26SE. 3.0 V6: SAAB: B308E, B308I, VAUXHALL / OPEL: X30XE. 3.2 V6: VAUXHALL/OPEL: Y32SE, .



53307

38,50€



ENGINE TIMING TOOL SET ALFA/OPEL/VAUXHALL 1.6, 1.8 16V

APPLICATIONS	OPEL / VAUXHALL: CORSA-D, AGILA, ASTRA-G-H, MERIVA, ZAFIRA-B, VECTRA-C, SIGNUM, INSIGNA	1.6, 1.8
	CHEVROLET: AVEO, CRUZE, ORLANDO	1.4, 1.6, 1.8
	ALFA ROMEO: 159 FIAT: CROMA	1.8
OEM TOOLS	E10290 (1), 23056-06 (2) (3), E10230 (4), 23164-04 (5), 23174-01 (6), 23056-05 (7)	
ENGINE CODES	OPEL / VAUXHALL: Z16LEL, Z16LER, Z16LET, Z16XE1, Z16XEP, Z16XER, A16XER, 18XER, A18XER, 2HO/A18XEL. CHEVROLET: G14D, LDD, LXV (F16D4), 2HO(Z18XER). ALFA / FIAT: 939A4.000.	



53316

34,00€

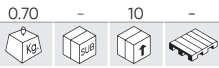

ENGINE TIMING TOOL SET FIAT/OPEL/VAUXHALL 2.2 16V CHAIN DRIVE

APPLICATIONS	OPEL: ASTRA-G (2000-2006), ASTRA-H (2006-2011), SIGNUM (2003-2008), VECTRA-B (2000-2002, VECTRA-C (2002-2008), ZAFIRA-A (2000-2005), ZAFIRA-B (2005-2012), SPEEDSTER (2000-2006). VAUXHALL: VX220 (2000-2006). FIAT: CROMA (2005-2009).
OEM TOOLS	VAUXHALL / OPEL: Z22SE, Z22YH FIAT: 194A1.000.



53317

34,00€

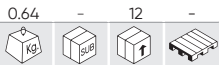

OPEL/VAUXHALL 2.2 ANTIFREEZE PUMP BLOCKER

APPLICATIONS	OPEL 2.2 Chain VAUXHALL 2.2 Chain
--------------	--------------------------------------



53452

26,50€

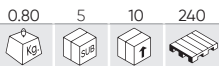

ENGINE TIMING TOOL SET OPEL/FORD/FIAT/ ALFA ROMEO/LANCIA/SUZUKI

APPLICATIONS	VAUXHALL/OPEL 1.3 CDTI: AGILA, CORSA, COMBO (03-08), ASTRA-H(05-08), MERIVA, TIGRA-B(04-08) SUZUKI 1.3 DDIS: IGNIS, WAGON R(03-08), SWIFT(04-08) FORD: 1.3 TDCI FIAT/ALFA ROMEO/LANCIA: 1.3 JTD MULTIJET
OEM TOOLS	104-A EN 46781 (1) , EN 46785 (2)

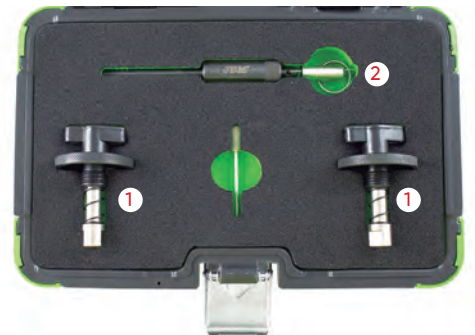

53651

91,00€



OPEL/VAUXHALL 1.0, 1.2, 1.4 TURBO ENGINE TIMING TOOL SET

APPLICATIONS	OPEL: ADAM, AMPERA, ASTRA-J, AVEO, CORSA-D, INSIGNIA, MERIVA-B, MOKKA, ZAFIRA-C TOURER
OEM TOOLS	EN 49977-100 (1), EN 49977-200 (2), EN 49978 (3), KM 952 (4), KM 953-A (5), KM 955-1 (6), KM 955-2 (7).
ENGINE CODES	1.0: A10XEP (LDB) 1.2: A12XEL (LWD), A12XER (LDC) 1.4: A14XEL (L2Z), A14XER (LDD), LDU A14NEL (LUH), A14NET (LUJ), TWINPORT / ECOFLEX ENGINES A14XFL (LUU), A14NEL (LDD), A14NEL (LUJ), A12XEL (L2Q)



54205

49,00€

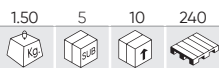

ENGINE TIMING TOOL KIT FOR VAUXHALL/OPEL 1.6 CDTI

APPLICATIONS	VAUXHALL/OPEL: Astra J (13-18), Astra K, (15-19), GTC (15-18), Insignia A (15-17), Insignia- B (17-20), Meriva B (13-17), Mokka (14-16), Mokka X (16-20), Zafira C Tourer (13-19).
OEM TOOLS	EN-6349, EN-6130 (1), EN-51143 (2), EN-51140 (3), EN-50513 (4), EN-51188 (5)
ENGINE CODES	B16DTC, B16DTE, B16DTH, B16DTJ, B16DTL, B16DTN, B16DTR and B16DTU. D16DTH, D16DTI, D16DTJ, D16DTN, D16DTR, D16DTU

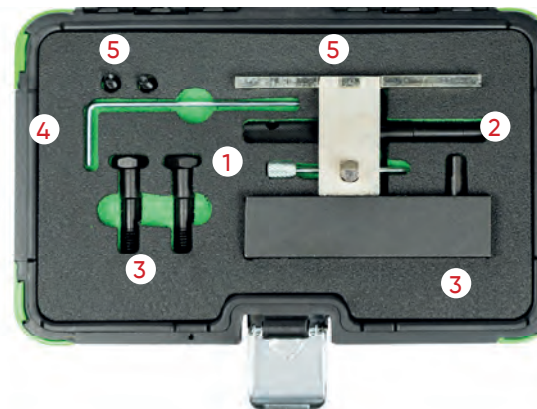

54214

96,00€



ENGINE TIMING TOOL SET OPEL/ISUZU 1.6D, 1.7D

APPLICATIONS	ASTRA, CAVALIES, VECTRA-A(87-00), ISUZU, NOVA, CORSA / COMBO, STRA, CAVALIER, VECTRA, FRONTERA, MONTEREY, MIDI, BRAVA (88-04)
OEM TOOLS	VAS 6079 (1), KM 951 (2), KM 851 (3), 23-029 (4), KM 661-2 (5), KM 661 (6)
ENGINE CODES	OPEL : 16DA, 17D, 17DR, X17DTL ISUZU : 4EC1, 4EE1, 4JB1, 4XJ1, 4JA1, 4JG1, 4FC1, 4FD1, 4FG1, Z17DT, Y17DT/DTL

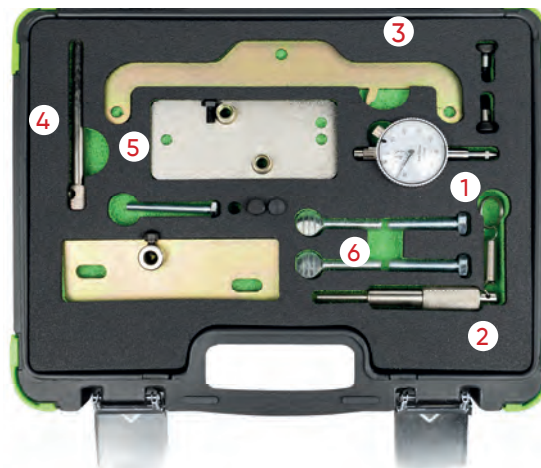

54217

104,00€



ENGINE TIMING TOOL SET FOR VAUXHALL/OPEL/SAAB 2.0, 2.2 DTI

APPLICATIONS	VAUXHALL/OPEL: ASTRA-G (98-06), FRONTERA-B (98-04), OMEGA-B, (98-03), SIGNUM (03-05), SINTRA (98-99), VECTRA-B (97-02), VECTRA-C (02-05), ZAFIRA-A (99-05), SAAB: 9-3 (98-04), 9-5 (02-06)
OEM TOOLS	SAAB: 83 95 394 (1), 83 95 337 (2), 83 95 352 (3), 83 95 386 (4) VAUXHALL/OPEL/SAAB: KM-927 (2), KM-929 (3), KM-932 (4), KM-933 (1)
ENGINE CODES	OPEL: X20DTH, X20DTL, Y20DTH, Y20DTL, X22DYH, Y22DTH, Y22DTR SAAB: D223L



54221

111,00€

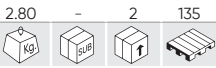

ENGINE TIMING TOOL SET FOR VAUXHALL/OPEL 1.3 CDTI

APPLICATIONS	VAUXHALL/ OPEL 1.3 CDTI Corsa E Diesel Engine From 2015
OEM TOOLS	KM-662-C (1), EN-50515 (2), EN-51500 (3), EN-46775 (4), KM-955-1 (5), EN-46785 (6)
ENGINE CODES	LKU B13DTE, LKU B13DTR



54434

48,50€

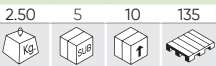

ENGINE TIMING TOOL SET OPEL 1.0, 1.4

APPLICATIONS	VAUXHALL/OPEL ADAM 2014 - 2019, ASTRA-K 2015 - 2019, CORSA-E 2015 - 2019, INSIGNIA-B 2017 - 2020, MOKKA X 2016 - 2019, VIVA (KARL) 2015 - 2020
OEM TOOLS	EN-51367 (1) EN-51298 (2) EN-51632 (3)
ENGINE CODES	1.0 L5Q/B10XE, L5Q/D10XE, LE1/B10XFL, LE1/B10XFT, LE1/B10XFL, LE1/D10XFL, LE1/D10XFT, LE1/F10XFL, LE1/F10XFT, LWT/B10XL 1.4 LE2/B14XFL, LE2/B14XFT, LE2/D14XFL, LE2/D14XFT, LFE/B14XNT, LFE/D14XNT, LV7/B14XE 1.5 LFV/B15XHT, LFV/D15XHL, LFV/D15XHT

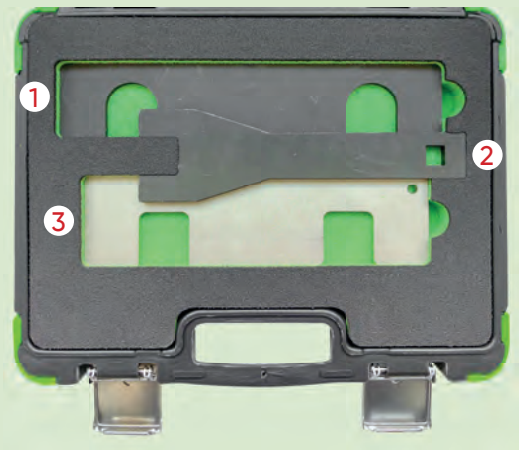

54435

14,50€

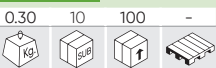

ENGINE TIMING TOOL SET OPEL/CHEVROLET/SAAB 1.4, 1.6, 1.8 ECOTEC

APPLICATIONS	CHEVROLET: LACETTI (2005-2010), NUBIRA (2005-2010) OPEL/VAUXHALL: ASTRA-G (1998-2004), ASTRA-H (2004-2007), COMBO-C (2005-2012), CORSA-C (2000-2007), MERIVA-A (2003-2010), SIGNUM (2003-2007), TIGRA-B (2004-2010) VECTRA-B (1995-2002), VECTRA-C (2002-2008), ZAFIRA-A (1999-2005), ZAFIRA-B (2006-2013) SAAB: 9-3 (2003-2010)
OEM TOOLS	KM-911 (1) KM-6130 (2) KM-852 (3), EN-852 (3)
ENGINE CODES	1.4: X14XE, Z14XE 1.6: X16SEJ, X16XEL, Y16XE, Z16XE, Z16YNG 1.8: F18D3 1.8: X18XE1, Z18XE, Z18XEL, X18E1 1.8: Z18XE

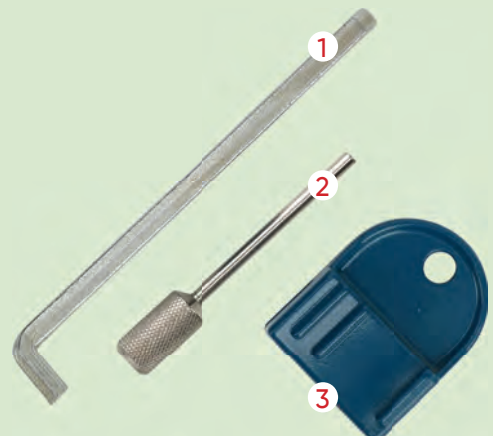

54436

124,00€



N

ENGINE TIMING TOOL SET OPEL 1.6 SIDI

APPLICATIONS	VAUXHALL ASTRA-J 2013 - 2017,ASTRA-K 2015 - 2019,CASCADA 2013 - 2019,GTC 2015 - 2019,INSIGNIA 2013 - 2017,INSIGNIA-B 2018 - 2020,ZAFIRA-C TOURER 2014 - 2019
OEM TOOLS	EN 51153 (1) EN 50513 (2) EN 51148 (3) EN 51147 (4)
ENGINE CODES	1,6 LWC/A16SHT LVP/A16XHT LWC/B16SHL LWC/B16SHT LVP/B16XHT LWC/D16SHJ LWC/D16SHL LWC/D16SHT

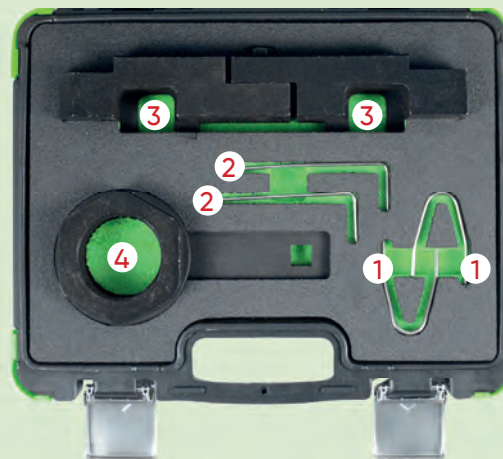

54437

110,00€



N

ENGINE TIMING TOOL SET OPEL/CHEVROLET/SAAB 2.0, 2.4

APPLICATIONS	CHEVROLET CAPTIVA 2011 - 2015,HHR 2008 - 2009, MALIBU 2012 - 2015 SAAB 9-3 (02-12) 2010 - 2012,9-5 (10-12) 2010 - 2012 VAUXHALL/OPEL ANTARA 2011 - 2016,ASTRA-J 2012 - 2017,GTC (15-19) 2015 - 2019,INSIGNIA-A (08-17) 2008 - 2013
OEM TOOLS	EN-48585 (1) EN 43653 (2), J 43653 (2) EN 955 10 (3), KM 955 (3) EN-955-20 (4), KM 955-20 (4) EN 45027 1 (5), J 45027 1 (5) EN 45027 (6), EN45027 2 (6), J 45027 2 (6) EN 49212 (7), EN 49212 1 (7) EN 49212 (8), EN 49212 2 (8) EN 48953 (9)
ENGINE CODES	LHU/A20NFT 2,0: LDK/A20NHT 2,0: LDK/A20NHT, LHU/A20NET, LHU/A20NFT, LHU/B20NFT 2,4: A24XE (LE5), A24XF (LE9) 2,4: LE5,LE9

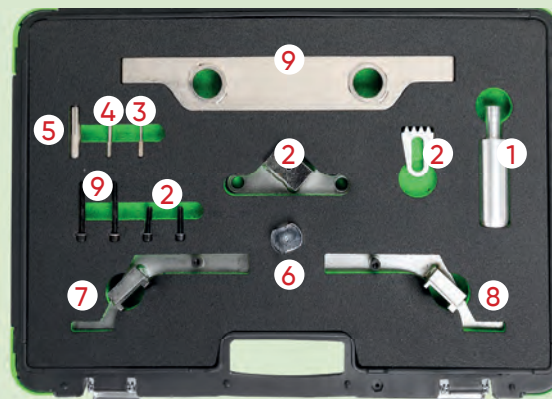

52271

18,00€

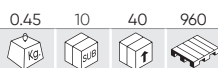

ENGINE TIMING TOOL SET VAG

APPLICATIONS	AUDI: A2 1.4TDI (02-06), A3 1.9, 2.0TDI (02-08), A4 1.6TDI (02-05), A4 1.9, 2.0TDI (04-08), A6 1.9TDI (02-05). SEAT: ALTEA 1.9SDI/TDI (05-08), LEON 1.9,2.0TDI (05-08), TOLEDO 1.9SDI/TDI (05-08). SKODA: FABIA 1.4TDI (03-06), OCTAVIA II 2.0TDI (03-06) VW: BEETLE 1.9TDI (02-08), BORA 1.9TDI (02-08), FOX 1.4TDI (02-08), GOLF 1.9, 2.0TDI (02-08), LUPO 1.4TDI (02-08), POLO 1.4, 1.9TDI (02-08), SHARAN 1.9TDI (02-08).
OEM TOOLS	AUDI: AMF, ASZ, ATD, AVB, AVF, AWX, AXR, AZV, BHC, BKC, BKD, BKE, BLB, BMN, BNA, BPW, BRB, BR, BRD, BRE, BRF, BUY, BVA, BVF, BVG. SEAT: BJB, BKC, BLS, BMM, BXE SKODA: AMF, AZV, BKD VW: AJM, AMF, ANU, ARL, ASZ, ATD, AUJ, AVB, AVF, AWX, AXR, BAY, BMS, BNM, BNV, BWB



51489

12,00€

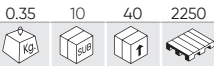

CAMSHAFT SETTING TOOL VAG 1.4, 1.6

APPLICATIONS	VW: LUPO 99 , POLO 95, CADDY 96, POLO CLASSIC, VARIANT 96, BEETLE 1.4L 99, GOLF 1.4L, 1.6L 98 Y 1.4L, BORA, 1.6L 99. AUDI: A2.
OEM TOOLS	T10016
ENGINE CODES	1.4 / 1.6 16V



53274

30,50€

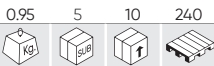

VOLKSWAGEN/SEAT/SKODA 1,2L ENGINE TIMING TOOL KIT

APPLICATIONS	VOLKSWAGEN 1.2: LUPO / POLO / EOS / FOX. SEAT 1.2: IBIZA / CORDOBA SKODA 1.2: FABIA
OEM TOOLS	T10123 (1) (2), T10120 (3), T10121 (4)
ENGINE CODES	AWY / BMD / AZQ / BME.



53275

35,50€

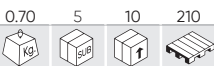

DIESEL ENGINE TIMING CRANK LOCKING TOOLS VW-AUDI

APPLICATIONS	DODGE: CALIBER (06-11) FORD: GALAXY (02-06) MITSUBISHI: GRANDIS (05-10), LANCER (05-10), OUTLANDER (07-10). SEAT: ALHAMBRA (00-15), ALTEA/ALTEA XL (04-15), CORDOBA (02-09), IBIZA (02-15), LEON (00-13), TOLEDO (04-11). SKODA: FABIA (00-14), FABIA II (07-15), OCTAVIA (00-10), OCTAVIA II (04-15), PRACTIK (10-15), RAPID (11-15), ROOMSTER (07-15), SUPERB (02-08), SUPERB II (08-15), YETI (09-14). AUDI: A1 (10-15), A2 (00-06), A3 (01-13), A4/ALLROAD (01-16), A5 (08-15), A6 (11-14), TT (08-14), Q3 (11-15), Q5 (08-15), A6 (10-14). VOLKSWAGEN: AMAROK (10-16), BEETLE (02-15), BORA (02-08), CADDY/MAXI (03-15), EOS (06-15), FOX (05-11), GOLF (02-15), GOLF PLUS (05-14), JETTA (05-15), LUPO (02-05), PASSAT/CC (02-15), POLO (99-14), SCIROCCO (08-14), SHARAN (02-15), TIGUAN (07-15), TOURAN (03-15), TRANSPORTER (03-17).
OEM TOOLS	DODGE: 9882, 9883. FORD: 310-085/23-059, 303-1054. MITSUBISHI: MB995206, MB995208, MB995209. VAG: T10100 (4), T10050 (1), 3359 (3/6)/T20102, T10115 (3), T10060A (2)/T40098, T20167.
ENGINE CODES	1.2D TDi CR: CFWA. 1.4D TDi PD: AMF, BAY, BMS, BNM, BNV, BWB. 1.6D TDi CR: CAYA, CAYB, CAYC, CAYD, CAYE, CLNA. 1.9D TDi PD: AJM, ANU, ARL, ASZ, ATD, AUY, AVB, AVF, AVQ, AWX, AXB, AXC, AXR, BJB, BKC, BLS, BLT, BMT, BPZ, BRM, BRR, BRS, BRU, BSU, BSV, BSW, BTB, BVK, BXE, BXF, BXJ. 2.0D TDi CR/TDi PD: AZV, BDJ, BDK, BEW, BGW, BHW, BKD, BKP, BKQ, BLB, BMA, BMM, BMN, BMP, BMR, BNA, BPW, BRA, BRC, BRD, BRE, BRF, BRT, BSS, BST, BSY, BUJ, BUZ, BVA, BVE, BVF, BVG, BVH, BWC, BWV, CAAA, CAAB, CAAC, CAAD, CAE, CAG, CAGB, CAGC, CAHA, CAHB, CBAA, CBAB, CBAC, CBBA, CBBB, CBDA, CBDB, CBDC, CBEA, CCHA, CCHB, CDBA, CDCA, CEGA, CFCA, CFFA, CFFB, CFFD, CFFE, CFGB, CFGC, CFHA, CFHB, CFHC, CFHD, CFHE, CFHF, CFJA, CGLA, CGLB, CGLC, CGLD, CJAA, CJCA, CJC, CJCC, CLCA, CLCB, CLJA, CLLA, CNEA, ECD, ECD/BSY, ECD/BYL, ECE/BWD.

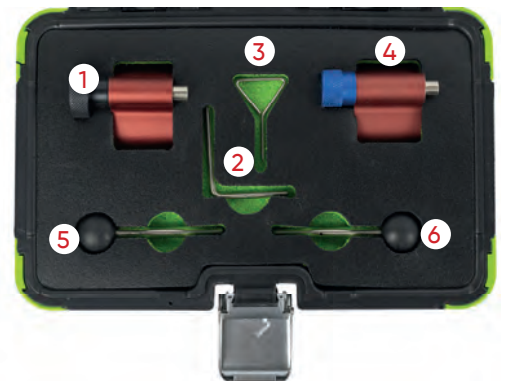

53276

160,00€



ENGINE TIMING TOOL AUDI & SKODA

APPLICATIONS	MOTOR AUDI, VW: V6 2.0, 2.8, 3.0T FSI. AUDI Q5: 2.0, A6L 2.8, 3.0T.
OEM TOOLS	3418 (1), 3458 (2), T10100 (3), T10123 (4), T10121 (5), 3242 (6), 3551 (8), T10020 (9), T10098 (10), 3078 (12), 2064 (13), 3369 (14), T10092 (15), T40011 (17), 2065A (18), T10016 (19), 3359 (20), T10008 (21), T10050 (22) T10265 (23), T10264 (24), T10060A (25), T10120 (27), 3366 (28)
ENGINE CODES	2.0, 2.8, 3.0

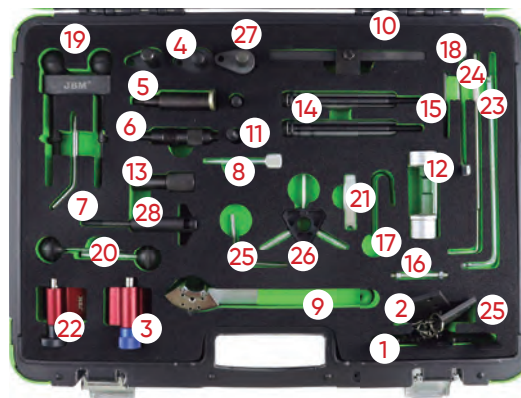

53277

45,00€

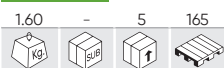

TIMING BELT DOUBLE PIN WRENCHES TOOLS SET VW- AUDI

APPLICATIONS	PETROL	AUDI: 80, 100, A3, A4, A6 1.6, 1.8/TURBO, 2.0, 2.0 16V, A3, A4 1.6 (96-). SEAT: IBIZA/CORDOBA, TOLEDO, ALHAMBRA, INCA 1.6, 1.8, 1.8 16V, 2.0, 2.0 16V, IBIZA/ CORDOBA, LEON, TOLEDO 1.6 (99-), ALHAMBRA 2.0 (00-). VOLKSWAGEN: POLO CLASSIC, SCIROCCO, CORRADO, GOLF, JETTA, VENTO, PASSAT, SHARAN, TRANSPORTER 1.6, 1.8/TURBO, 1.8 16V, 2.0, 2.0 16V, POLO CLASSIC, GOLF, BORA, BEETLE 1.6 (97-), 2.0 (99-). SKODA: OCTAVIA 1.6 (97-), 2.0 (99-).
	DIESEL	AUDI: 80, 100, A3, A4, A6 1.9 TURBO D, 1.9TDI, 2.5TDI, A3, A4, A6 2.0TDI, A2, A3, A4, A6 1.2TDI, 1.4TDI, 1.9TDI (99-). SEAT: IBIZA/CORDOBA, LEON, TOLEDO, ALHAMBRA, INCA 1.7SDI, 1.9D/TD /SDI/TDI. EQRD: GALAXY (02-06). SKODA: FELICIA, OCTAVIA 1.9D/TDI. VW: POLO, POLO CLASSIC, GOLF, JETTA, VENTO, BORA, BEETLE, PASSAT, SHARAN, CADDY, TRANSPORTER 1.5D, 1.6D/ TURBO, 1.7D/SDI, 1.9SDI/TDI, GOLF, PASSAT 2.0TDI.
OEM TOOLS	T10020 (1), 3387 (2), V159 (3), T10060/T100604 (4), T10115 (5), T40011 (6)	
ENGINE CODES	2.0, 2.8, 3.0	



53278

143,00€



AUDI VW ENGINE TIMING TOOL SET AUDI 2.8, 3.2 FSI, 3.0 TFSI

APPLICATIONS	A2, A4, A4 QUATTRO, A6 (2004-2007) A2, A3, A4, A3 FSI (2004-2007) A4, A6, A8 3.2 FSI A6 L QUATTRO 2.4 A6 2.4, A6 2.4 QUATTRO (2004-2007) A4 3.2 FSI (2004-2007) A6 3.2 FSI (2004-2007) A8 3.2 FSI (2005-2007)
OEM TOOLS	T10172 (1), 3212 (2), T40070 (3), T40069 (4), T40071 (5), T10172/2 (6)
ENGINE CODES	AUK / BDW / BDX / BKH / CAJA / CALA



53279

97,00€

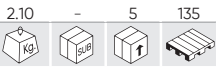

VW/AUDI 1.8, 2.0, TSI, TFSI SOHC TURBO ENGINE TIMING TOOL SET

APPLICATIONS	AUDI: A3 (96-09), A4 (94-09), A6 (95-11), S3 (99-13), TT (98-14). SEAT: ALHAMBRA (97-10), ALTEA/ALTEA XL (06-09), CORDOBA (99-02), EXEO (09-10), IBIZA (99-02), LEON (99-13), TOLEDO (99-09). SKODA: OCTAVIA/OCTAVIA TOUR (98-10), OCTAVIA II (04-09). VOLKSWAGEN: BEETLE (99-11), BORA (97-04), EOS (06-10), GOLF (97-12), GOLF PLUS (05-09), JETTA (05-09), PASSAT (96-10), SCIROCCO (09-14), SHARAN (97-10), TOURAN (03-09).
OEM TOOLS	T10020 (1), T10252 (2), T10092 (3), T10115 (4), T40011 (4), 3366 (5), T10060 (6)
ENGINE CODES	1.8: ADR, AFY, AGN, AJP, APG, APT, AQE, ARG, ARH, AVV. 1.8T: AEB, AGU, AJH, AJL, AJQ, AMK, AMU, ANB, APP, APU, APX, APY, AQA, AQX, ARX, ARY, ARZ, AUM, AUQ, AVC, AWC, AWT, AWU, AYP, BAM, BFV, BVP, BVR. 2.0 TSI: AXW, BHD, BLR, BLX, BLY, BMB, BVX, BVY, BVZ. 2.0 TFSI/S/R/TSI: AXX, BPY, BWA, BGB, BPG, BPJ, BUL, BWE, BWT, BYK, BHZ, BZC, BWJ, BYD, CDLA, CDLB, CDLC, CDLD, CDLF, CDMA.



53280

112,00€

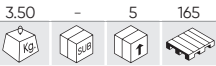

CAMSHAFT ALIGNMENT SET VW/AUDI 3.0 V6

APPLICATIONS	AUDI: A4 (01-08), A6 (01-08), A8 (03-10).
OEM TOOLS	3387 (1), T40030 (2) (4), T40026 (3), T40028 (5)
ENGINE CODES	3.0 V6 30V: ASN, AVK, BBJ, BGN.



53281

55,00€

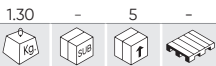

CAMSHAFT ALIGNMENT TOOL VW/AUDI

APPLICATIONS	VOLKSWAGEN: 2.5 TDi V6 AUDI: A4, A6, A8
OEM TOOLS	3369 (1), 3242 (2), 3458 (3)
ENGINE CODES	AFB/AKN



53282

48,00€



FRETWORK KIT VAG GROUP 1.2, 1.4, 1.6

APPLICATIONS	SEAT: ALHAMBRA (10-15), ALTEA/ALTEA XL (08-15), IBIZA/CORDOBA (08-12), LEON (07-13), TOLEDO (07-15). VOLKSWAGEN: BEETLE (11-15), CADDY/CADDY MAXI (10-15), EOS (06-12), GOLF (03-12), GOLF PLUS (03-14), GOLF V ESTATE (07-13), GOLF VI CABRIOLET (10-15), JETTA (06-14), PASSAT (05-11), POLO (02-14), SCIROCCO (08-12), TIGUAN (07-12), TOURAN (03-15). SKODA: FABIA II (07-15), OCTAVIA II (04-15), PRAKTIK (10-15), RAPID (12-15), ROOMSTER (06-15), SUPERB II (09-14), YETI (09-14). AUDI: A1 (10-15), A3 (03-13).
OEM TOOLS	T10171 (1), T10170 (2), T40011 (3)
ENGINE CODES	1.2 TFSI: CBZA, CBZB, CBZC. 1.4 FSI: AXU, BKG, BLN. 1.4 TFSI: BLG, BMY, BWK, CAVA, CAVB, CAVC, CAVD, CAVE, CAVF, CAXA, CAXC, CDGA, CSMA. 1.6 FSI: BAG, BLF, BLP, BTS.



53283

92,00€



SHIM KIT GROUP VAG 2.7, 3.0 TDI

APPLICATIONS	VOLKSWAGEN: TOUAREG, PHATEON VAG: DIESEL 2.7 / 3.0 V6 AUDI: A4, A5, A6
OEM TOOLS	3242 (1), T40060 (2) (3), 3359 (4), T40058 (5), T40061 (6), T40062 (7), T40049 (8)
ENGINE CODES	ASB, BKN, BKS, BWZ, BNG, BPP, BSG, BUG, BUN, CAWA, CAMB, CANA, CANB, CANC, CAND, CAPA, CARA, CARS, CASA, CASE, CASC, CAM, CC/HA, CCWA, CCWB, CDYA, CDVB, CDVC, CEXA, CGKA, CGKB.

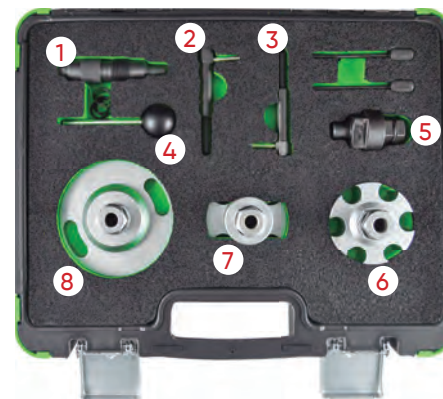

53284

306,00€



TIMING KIT GROUP VAG 2.5 TDI

APPLICATIONS	VOLKSWAGEN: TOUAREG (03-10), TRANSPORTER (03-09).
OEM TOOLS	T10225 (1), T10199 (2), T10234 (3), T10226 (4), T10193 (5), T10194 (6), T10199/01 (7), T10226 (8)
ENGINE CODES	2.5D TDI PD: AXD, AXE, BAC, BLJ, BLK, BNZ, BPC, BPD, BPE.



53285

56,00€

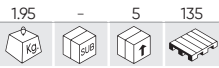

DIESEL ENGINE SETTING/LOCKING KIT VAG 2.4, 2.5, SDI, TDI

APPLICATIONS	<u>VOLKSWAGEN</u> : CRAFTER (06-13), LT (96-06), TRANSPORTER (90-03).
OEM TOOLS	2065A (1), T50009 (2), T10025 (3), 3248/3419 (4), 2064 (5), 3355 (6)
ENGINE CODES	2.4D: AAB, AJA. 2.5D SDI: AGX. 2.5D TDI: ACV, AHD, AHY, AJT, ANJ, APA, AUF, AVR, AXG, AXL, AYC, AYY, BBE, BBF. 2.5D TDI CR: BJJ, BJK, BJL, BJM.



53286

87,00€

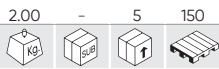

ENGINE TIMING TOOL KIT VAG 1.8, 2.0 TSI, TFSI

APPLICATIONS	<u>VOLKSWAGEN</u> : 1.8 / 2.0 TSI / TFSI.
OEM TOOLS	T10368 (2), T10354 (3), T40271 (1)(4), T10352/2 (5), T10352/1 (6), T10352 (7), T40196 (8) (9) (10) (11), T40267(12) (13), T40098 (14), T10060A (15), T40011 (15)
ENGINE CODES	BYT, BZB, CABA, CABB, CABD, CADA, CAEA, CAEB, CAWA, CAWB, CBFA, CCTA, CCZA, CCZB, CCZC, CDAA, CDAB, CDHA, CDHB, CDNB, CDNC, CDND, CESA, CETA, CFKA, CGYA, CJEB, CJBA, CJSB.



53287

245,00€

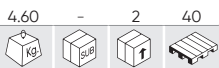

TURBO TIMING SET VW/AUDI 1.8, 2.0 TURBO

APPLICATIONS	<u>VOLKSWAGEN</u> <u>AUDI</u>	1.8 / 2.0 TURBO
OEM TOOLS	T10355 (1), T40196 (2), T40271 (3) (4), T10352 (5), T10352/1 (6), T10352/2 (7), T10368 (7), T40267 (8), T10354 (9), T40265 (10), T40011 (11) (14), T40098 (12), T10060A (13)	
ENGINE CODES	BYT, BZB, CABB, CABD, CADA, CAEA, CAEB, CAWA, CAWB, CBFA, CCTA, CCZA, CCZB, CCZC, CDAA, CDAB, CDHB, CDNB, CDNC, CDND, CESA, CETA, CFKA, CGYA, CJEB, CJSA, CJSB.	

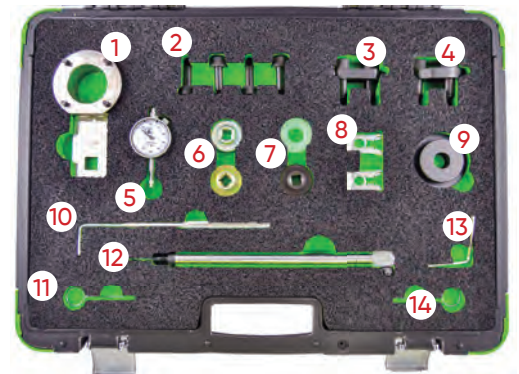

53288

72,00€

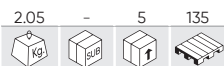

TIMING TOOL SET FOR VAG 1.6, 2.0 TDI COMMON RAIL

APPLICATIONS	SEAT: EXEO, LEON, ALTEA, TOLEDO, IBIZA. VOLKSWAGEN: JETTA, TOURAN, GOLF, GOLF PLUS, POLO, PASSAT, TIGUAN, SCIROCCO. SKODA: ROOMSTER, FABIA, PRAKTIK, OCTAVIA, YETI, SUPERB. AUDI: A1, A3, A4, A5, Q5, A6, TT.
OEM TOOLS	T10264 (1), T10265 (2), T20102 (3), T10052 (4), T10051 (5), T10255 (6), T10050 (7), T10100 (8), T40098 (9)
ENGINE CODES	1.2 TDI CR, 1.6 D TDI CR, 2.0 D TDI CR CAGA, CAGB, CAGC, CAHA, CAHB, CFHC, CBAA, CBAB, CFFB, CGLA, CGLB, CJCA, CJCB, CAAA, CBAA, CBAB, CBAC, CBBA, CBBB, CBDA, CBDB, CBDG, CCHA, CEGA, CJAA, CAAB, CAAC, CFJA, CFWA, CAYB, CAYC, CAYA.



53320

12,00€

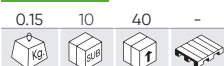

LOCKING TOOL SET FOR VAG

APPLICATIONS	SEAT: ALHAMBRA, ALTEA, AROSA, CORDOBA, IBIZA, LEON, TOLEDO 1.4/1.9/2.0 TDI. VW: PASSAT 1.9. AUDI: A4/A6 1.9.
OEM TOOLS	T10008, T20102, T10100.



53321

10,50€

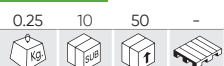

TENSIONER WRENCH FOR VAG

APPLICATIONS	AUDI: A4/1.8T, 2.0 1999-2004 A6/1.8T 2002-2004 A4/3.0 (2002 -), A6/3.0 (2002 -), A8/7.0 (2003 -). VW: GOLF PASSAT 2.0 TDI DIESEL, GOLF 88-97, PASSAT 92-97, VW T4/2.0 1992-2004.
OEM TOOLS	T10020



53325

7,50€

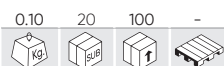

TENSIONER PULLEY WRENCH FOR VW AUDI 35MM

APPLICATIONS	AUDI: 100 ('91-), A6 (2.5 TDI) 2.3, 2.4, 2.5, 2.8, 2.9D TDI (1991-2003) VW: LT, TRANSPORTER
OEM TOOLS	3355
ENGINE CODES	AAB, AAT, ACU, ACV, AEL, AET, AGX, AHG, AHY, AJA, AJT, ANJ, APA, APL, AUF, AVT, AXG, AXL, AYC.



TIMING TOOLS

53326

16,00€

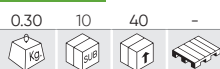

ENGINE TIMING TOOLS VW/AUDI

APPLICATIONS	VW: V6 2.5TDi. AUDI: V6 2.5TDi, V8 3.3TDi.
OEM TOOLS	3458 (1), 3242 (2)



53327

11,00€



ENGINE TIMING TOOLS VAG 1.2

APPLICATIONS	SEAT: IBIZA1.2 6V/3CYL (2002-09), CORDOBA 1.2 12V/3CYL (2002-13). VW: POLO 1.2 6V-12V/3CYL (2002-14). SKODA: FABIA 1.2 6V-12V/3CYL (2002, 2003-), FABIA II 1.2 6V/3CYL (2007-13), ROOMSTER 1.2 12V/3CYL (2006-13), PRAKTIK 1.2 6V/3CYL (2007-13).
OEM TOOLS	T10123
ENGINE CODES	1.2 6V: AWY, BMD, BBM, CHFA, CHFB 1.2 12V: AZQ, BME, BVX, BZG, CEVA, CGPA, CGPB, CGPC.



53648

107,00€



TIMING BELT SETTING KIT FOR VAG 1.0, 1.2, 1.4 TSI

APPLICATIONS	AUDI: A1 (12-15), A1 SPORTBACK (12-15), A3 (13-15), A3 SPORTBACK (12-15). SEAT: IBIZA (12-15), LEON (12-15), TOLEDO (12-15). SKODA: FABIA (10-13), OCTAVIA II (10-13), OCTAVIA III (10-15).
OEM TOOLS	T10060A (1), T10340 (2), T10476 (3), T10494 (4), T10499 (5), T10504/1 (6), T10504 (7), T10504/2 (8).
ENGINE CODES	1.2 TSI: CJZA, CJZB. 1.4 TSI: CGGA, CHPA, CMBA, CPVA, CRJA, CXSA. 1.4 TSI ACT: CPTA.

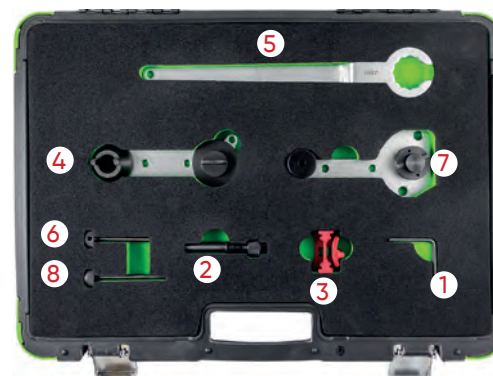

53649

89,00€



VAG GROUP ENGINE TIMING TOOL SET

APPLICATIONS	AUDI SEAT	SKODA VW
OEM TOOLS	T10340 (1), T10476 (2), T10477 (3), T10487 (4), T10494 (5), T10499 (6)	
ENGINE CODES	1.0 MPI: CHYA. 1.0 TSI: CHZE, CHZC, CHZA, CHZB, CHZC, CHZD, CHZJ. 1.2 TSI: CJZB, CJZC, CYVA, CJZA, CJZD, CYVB. 1.4 TSI: CZCC, CMBA, CZCA, CHPA, CPTA (ACT), CZDA, CVNA, CZEA (ACT).	

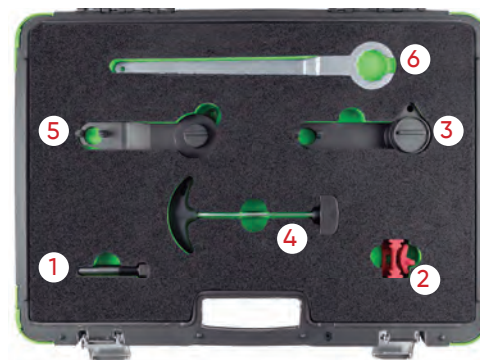

53706

98,00€

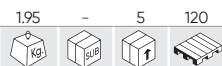

CAMSHAFT ALIGNMENT TOOL KIT VAG 1.4, 1.6, 2.0 TDI COMMON RAIL

APPLICATIONS	VOLKSWAGEN: GOLF ALLTRACK, GOLF SPORTSVAN, GOLF VII, GOLF VII KOMBI, PASSAT, POLO. AUDI: A1, A1 SPORTBACK, A3, A3 CABRIOLET, A3 LIMOUSINE, A3 SPORTBACK, TT, TT ROADSTER. SEAT: IBIZA, IBIZA V SPORTCOUPE, IBIZA V ST, LEON, LEON SC, LEON ST, TOLEDO IV. SKODA: FABIA, FABIA KOMBI, OCTAVIA, OCTAVIA COMBI, RAPID, RAPID SPACEBACK.
OEM TOOLS	OEM 3204 (1), OEM 3359 (2), OEM T10490 (3), OEM T10051 (4), OEM T10060A (5), OEM T10264 (6), OEM T10265 (7), OEM T10492 (8), OEM T40098 (9).
ENGINE CODES	1.4, 1.6, 2.0 TDI CR CXXB, DBKA, DCXA, CGLE, CKFB, CKFC, CLHA, CLHB, CNHA, CNHC, CRBD, CRFA, CRFC, CRKA, CRKB, CRLB, CRLC, CRMB, CRUA, CRVA, CRVC, CSUA, CSUB, CUNA, CUPA, CUSA, CUSB, CUTA, CUUD, CXEB, DBKA, DCXA, DCXA, DFSD.

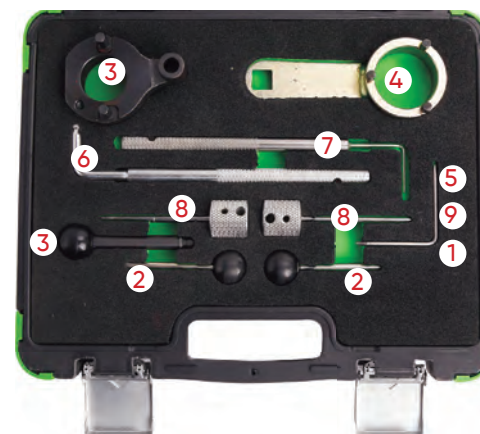

54092

24,00€



TIMING TOOL SET FOR VAG 1.2 TFSI

APPLICATIONS	AUDI: A1, A3, A3 SPORTBACK, A3 CABRIO SEAT: ALTEA, ALTEA XL, IBIZA, LEON, TOLEDO SKODA: FABIA II, OKTAVIA II, PRAKTIK, RAPID, RAPID SPACEBACK, ROMMSTER, YETI VW: BEETLE, CADDY, CADDY MAXI, GOLF PLUS, GOLF VI, GOLF VI CABRIO, GOLF VI ESTATA, JETTA, POLO, TOURAN
OEM TOOLS	T10340(1), T10414(2), T10341(3)
ENGINE CODES	CBZA, CBZB, CBZC

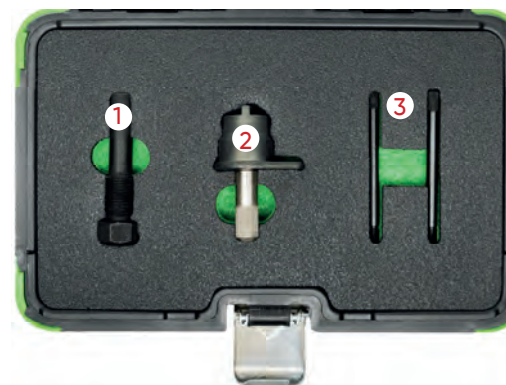

54199

94,00€

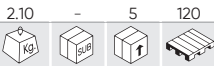

ENGINE TIMING TOOL KIT FOR VAG TFSI, FSI

APPLICATIONS	AUDI: A1 (10-15), A1 SPORTBACK (10-15), A3 CABRIOLET (10-13), A3 (10-15), A3 SPORTBACK (03-13) SEAT: ALTEA/ALTEA XL (10-15), IBIZA (10-15), LEON (10-13), TOLEDO (12-15) SKODA: FABIA II (10-15), PRAKTIK (10-15), RAPID (12-15), RAPID SPORTBACK (12-15), OCTAVIA II (04-13), YETI (09-15), YETI OUT-DOOR (13-15) VW: BEETLE (11-15), CADDY/CADDY MAXI (10-15), EOS (07-15), GOLF V (03-13), GOLF V ESTATE (07-09), GOLF VI (10-13), GOLF VI ESTATE (10-13), GOLF VI CABRIOLET (11-15), GOLF PLUS (05-14), JETTA (05-14), PASSAT (05-15), POLO (09-14), SCIROCCO (08-14), TIGUAN (07-15), TOURAN (03-15)
OEM TOOLS	T10414 (1), VAS 6079 (2), T10170 (3), T10171/ T10171A (4), T40011 (5), T10340 (6), T10341 (7)
ENGINE CODES	1.2 TFSI: CBZA, CBZB, CBZC 1.4 FSI/TFSI: BLG, BMY, BWK, CAVA, CAVB, CAVC, CAVD, CAVE, CAVF, CAXA, CAXC, CDGA, CSMA 1.6 FSI: BAG, BLF, BLP

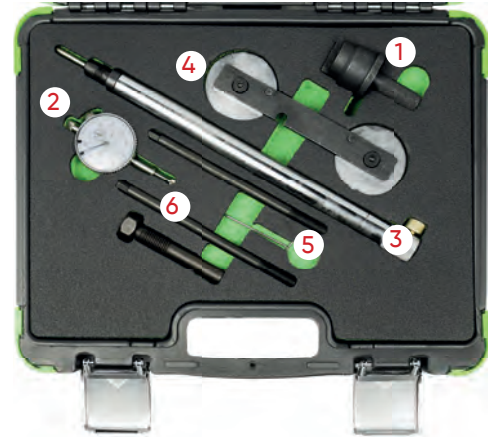

54218

142,00€



VAG VIBRATION DAMPER ASSEMBLY TOOL

APPLICATIONS	AUDI, SEAT, SKODA, VOLKSWAGEN
OEM TOOLS	T10531/1 (1), T10531/2 (2), T10531/3 (3), T10531/4 (4)
ENGINE CODES	1.8L TFSI: BZB, CDAA, BPU, BYT, CABA, CABB, CDHA, CDHB, CABD, DAJB, CJSB, CJSB, CJEB, CJEE, CJED, CYGA, CDAC, CJSC, CGYA, DAJA 2.0L TFSI: CAWB, CCZA, CBFA, CCTA, CDNB, CDNC, CDND, CJXA, CJXE, CJXH, CHHB, CHHA, CULA, CFKA, DEDA, CHJA, CAWA, CCZC, CCZD, CPSA, CJK, CJKB, CESA, CETA, CFPA, CNCD, CPLA, CYRB, CYRC; CNCE, CYNB, CYPB, CULB, CULC, CNCB, CWZA, CJXF, CJXC, CJXB, CJXG, CHHC, CCZB



54407

397,00€



CAMSHAFT ASSEMBLY TOOL KIT FOR VAG/PORSCHE

APPLICATIONS	AUDI, PORSCHE, SEAT, SKODA, VOLKSWAGEN 1.2 - 1.6 - 2.0 - 2.7 - 3.0 - 4.0 - 4.2 COMMON RAIL
OEM TOOLS	T40094, T40094/1 (1), T40094/2 (2), T40094/3 (3), T40094/4 (4), T40094/5 (5), T40094/6 (6), T40094/7 (7), T40094/8 (8), T40094/9 (9), T40094/10 (10), T40094/11 (11), T40094/12 (12), T40095 (13), T40096 (14), T40096/1 (15)
ENGINE CODES	ASB, ASE, BKN, BKS, BMK, BNG, BPP, BSG, BTR, BUG, BUN, BVN, CAAA, CAAB, CAAC, CAAD, CAAE, CAGA, CAGB, CAGC, CAHA, CAHB, CAMA, CAMB, CANA, CANB, CANC, CAND, CAPA, CARA, CASA, CASB,CASC, CASD, CATA, CAYA, CAYB, CAYC, CAYD, CAYE, CBAA, CBAB, CBAC, CBBA, CBBB, CBDA, CBDB, CBDC, CCEA, CCFE, CCHA, CCHB, CCLA, CCMA, CCWA, CCWB, CDBA, CDCA, CDSB, CDTA, CDTB, CDUC, CDUD, CDYA, CDYB, CDYC, CEGA, CEXA, CFCA, CFFA, CFFB, CFFD, CFFE, CFGB, CFGC, CFGD, CFHA, CFHB, CFHC, CFHD, CFHE, CFHF, CFJA, CFWA, CGKA, CGKB, CGLA, CGLB, CGLC, CGLD, CGLF, CGQB, CJAA, CJCA, CJCB, CJCC, CJCD, CJGA, CJGC, CJGD, CJMA, CKDA, CKTB, CKTC, CKUB, CKUC, CKVB, CKVC, CLAA, CLAB, CLCA, CLCB, CLJA, CLLA, CLNA, CLZB, CMEA, CMFA, CMFB, CMGB, CMHA, CNEA, CNFA, CNRB, CRCA,CSHA, M05/9D(CAS), M05/9E, M05/9E(CRCA), M05/9E(CRCB)

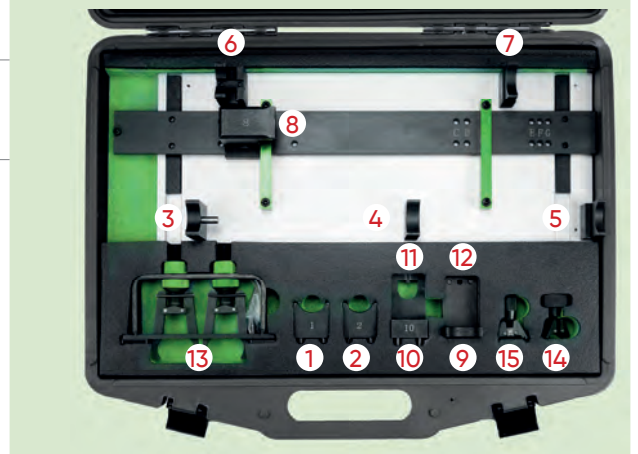

54408

46,00€



N

ENGINE TIMING TOOLS SET VAG DIESEL 1.7, 1.9, SDI, TDI

APPLICATIONS	AUDI: A3, A4, A6, CABRIOLET, SEAT: ALHAMBRA, AROSA, CORDOBA, IBIZA, INCA, LEON, TOLEDO, SKODA: FELICIA, OCTAVIA VW: BORA, CADDY, FOX, GOLF, LT, LUPO, PASSAT, POLO, SHARAN, TRANSPORTER, VENTO
OEM TOOLS	T1020 (1), 2587 (2), 2065A (3), T20044 (4), T10098 (5), T40011 (6), 2064 (7), T3359 (8), T10092 (9), M5x60M (10)
ENGINE CODES	1.7TDi/SDi: AHB, AHG, AKU, AKW 1.9TDi/SDi: 1X, 1Y, 1Z, ABL, AAZ, AEF, AEY, AFF, AFN, AGD, AHF, AHH, AHU, AGP, AGR, ALE, ALH, AQM, ASV, ASY, ASX, AVG, AYQ 2.4D: 1G, 1S, DW, DV, ACL, ACT

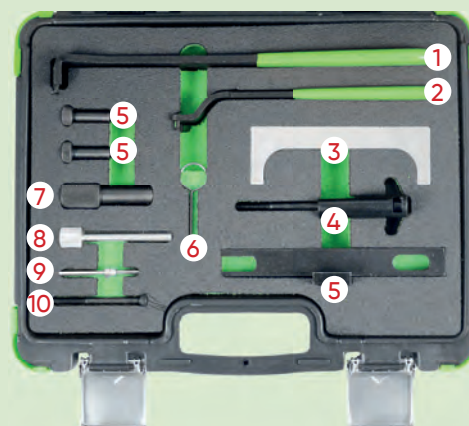

54409

32,00€



N

ENGINE TIMING TOOL SET VAG 1.4 TSI

APPLICATIONS	ATECA (2016-) A3 (2012-) SUPERB (2015-) A1 SPORTBACK (2012-2018) LEON/LEON ST (2012-2020) MK5 (2012-2018) Q2 (2016-) Q3 (2015-2018)
OEM TOOLS	T10340 (1) T10504 (2) T10504/1 (3) T10504/2 (4)
ENGINE CODES	1.4 TFSI (CoD)-CPTA, CZEA 1.4 TSI (ACT)-CPTA, CZEA

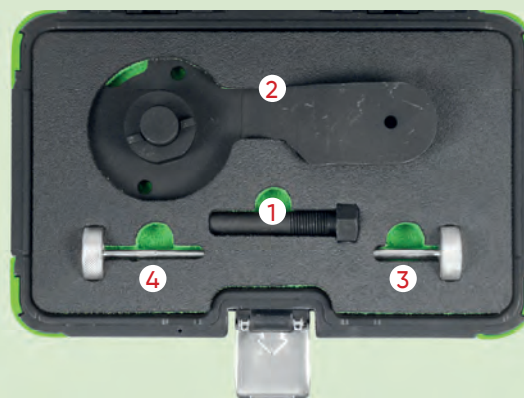

54410

33,50€



N

ENGINE TIMING TOOLS SET VAG 2.4, 3.2 FSI

APPLICATIONS	AUDI: A4, A5, A6, A7, A8, Q5, Q7, R8, RS4, RS5, RS6, S4, S5, S6, S8 VW: TOUAREG
OEM TOOLS	T40058 (1) T40069 (2) T40071 (3) T40133 (3) T40133/1 (3) T40133/1/2 (3) T40133/2 (3) 40071 (4)
ENGINE CODES	2.4: BDW 3.2: AUK, BKH, BPK 4.2: BAR, BNS, BVJ, CAUA, CDRA, CFSA, BYH, CNDA 5.0: BUH 5.2: BSM, BUJ, BXA, CMPA, CTPA, CTYA

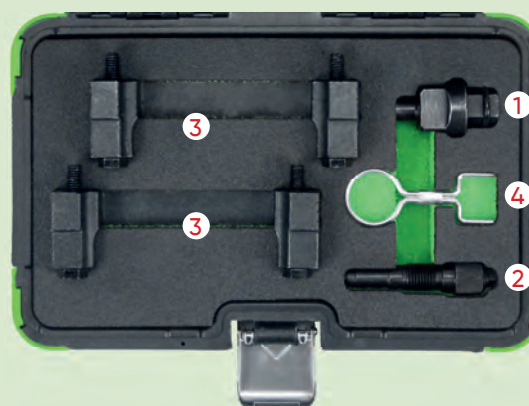

TIMING TOOLS

54411

36,00€

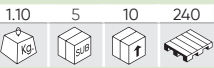

N

ENGINE TIMING TOOL SET VAG/PORSCHE 2.4, 2.8, 3.0 TFSI

APPLICATIONS	AUDI: A4 (2011-2015) A5 (2007-2017) A6 (2007-2018) A7 (2010-2018) A8 (2010-2018) A8 (2010-2018) Q7 (2010-2018) S4 (2009-2017) S5 (2010-2017) S5 (2010-2017) Q5 (2008-2017) SQ5 (2013-2018) PORSCHE: CAYENNE (2010-2014) PANAMERA 2011-2013 VAG: TOUAREG (2010-2014)
OEM TOOLS	T40133/1 (1) T40133/2 (2) T40058 (3) T40069 (4) T40071 (5)
ENGINE CODES	AUDI: 2,5 CLXB, CPAA 2,8 BDX, CCDA, CCEA, CHVA, CJBA, CNYA 3,0 CAJA, CAKA, CCAA, CGEA, CGWA, CGWB, CGWC, CGWD, CGXB, CGXC, CHMA, CHMB, CJTB, CJTC, CJWC, CMDA, CMUA, CNA, CREA, CREC, CRED, CTTA, CTUA, CTUD, CTVA, CTWA, CTXA 3,2 CALA, CALB PORSCHE: 3,0 M06/EC VAG: 3,0 CJTA, CGFA



54412

57,00€

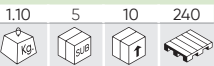

N

ENGINE TIMING TOOL SET AUDI 2.5 TFSI

APPLICATIONS	AUDI: RSQ3 (2013-2015), RSQ3 (2015-2018), RS3 (2010-2013), RS3 (2015-2017), TT (2009,2014)
OEM TOOLS	T03003 (1) T40264/1/2 (2), T40264/2A (2) T40069 (3) T40011 (4) T40297 (5)
ENGINE CODES	2,5 TFSI/RS CEPA, CEPB, CTSA, CZGA, CZGB

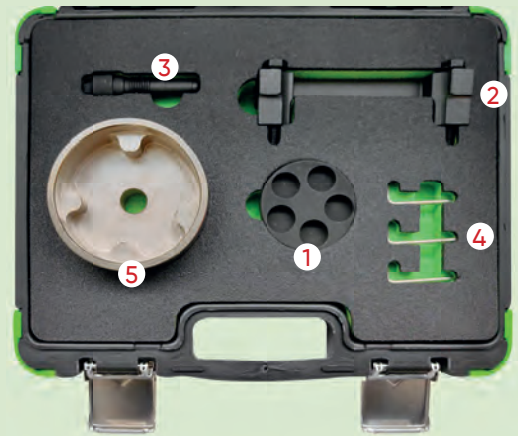

54413

115,00€



N

ENGINE TIMING TOOL SET AUDI 4.0 FSI, TFSI

APPLICATIONS	AUDI: A8, RS6, RS7, S6, S7, S8 (2012-2018)
OEM TOOLS	T40071 (1) T40257 (2) T40264/1 (3) T40264/2 (4) T40264/3 (5) T40269 (6) T40272 (7)
ENGINE CODES	CEUA CEUC CGTA CRDB CTFA CTGA CTGE CWUB CWUC DDTA

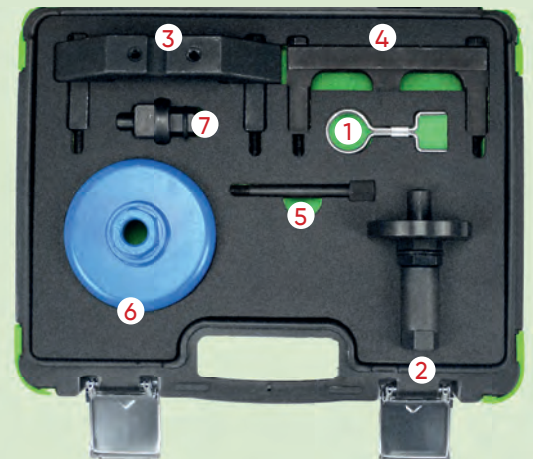

54431

184,00€



N

ENGINE TIMING TOOL SET ALFA ROMEO/MASERATI 2.9

APPLICATIONS	ALFA ROMEO: GIULIA, STELVIO MASERATI: 3,8T
OEM TOOLS	1860815000 (1) 2024000090 (2) 2024100000 (3)
ENGINE CODES	2.9: 670050436,670051007 ,670052721 ,670052722



53315

285,00€



ENGINE TIMING TOOL SET VOLVO 3.0, 3.2T6 / LAND ROVER 3.2

APPLICATIONS	VOLVO: S60 (10-16), S80 (07-15), XC60 (08-15), XC70 (06-15), XC90 (10-14), V60 (10-15), V70 (10-15). LAND ROVER: FREELANDER II (11-14).
OEM TOOLS	VOLVO: 999-7263 (3), 999-7264 (1), 999-7272 (5), 999-7257 (2), 999-7261 (4). LAND ROVER: 303-1225 (3), 303-1226 (1), 303-1219 (2), 303-1223 (4).
ENGINE CODES	3.0 TURBO: B6304T2, B6304T4. 3.2: B6324S, B6324S5. 3.2i6: B6324S.

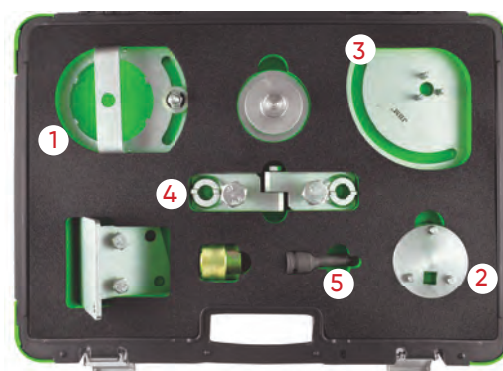

54226

71,00€



PULLER SET FOR HIGH PRESSURE PUMP PULLEY FOR HYUNDAI/KIA

APPLICATIONS	HYUNDAI: ACCENT (11-15), ELANTRA (07-10), I20 (09-18), I20 (10-18), I20 COUPE (15-17), I30 (07-19), IX35 (10-16), I40 (11-18) KIA: CARENS (13-18), CEED (07-18), OPTIMA (11-15), PRO-CCEED (08-19), RIO (09-17), CERATO (05-07), SOUL (09-14), SPORTAGE (10-18), VENGA (09-18)
OEM TOOLS	09331-2A000/2A010 (1), 09331-2A010 (1)
ENGINE CODES	1.1D CRDI: D3FF 1.4D CRDI: D4FC(U1), D4FC(U2) 1.6D CRDI: D4FB(U1), D4FB(U2), D4FB-H(U1), D4FB-H(U2), D4FB-L(U1) 1.7D CRDI: D4FD(U2), D4FD-H(U2), D4FD-L, D4FD-L(U2)



TIMING TOOLS

54200

56,00€

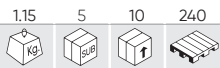

ENGINE TIMING TOOL SET FOR PORSCHE

APPLICATIONS	911 (2001 - 2008), BOXSTER (2002 - 2011), CAYMAN (2006 - 2009)
OEM TOOLS	9685 (1), 9686 (2), 9595 (3), 9595/1 (4)
ENGINE CODES	M96/03, M96/05, M96/23, M96/25, M97/20, M96/24, M96/26, M97/01, M97/21, M97/22.



51927

25,00€

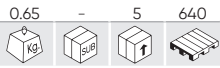

AUXILIARY STRETCH BELT REMOVAL/INSTALLATION TOOLS

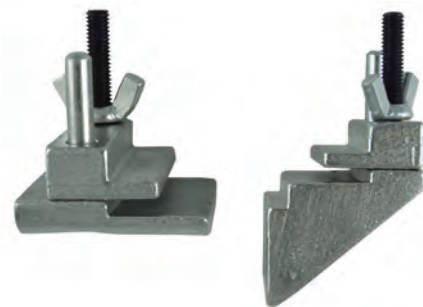

51340

39,30€

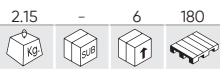

UNIVERSAL PULLEY & FAN CLUTCH HOLDER SET



52616

44,00€

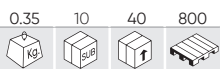

CAMBELT TENSIONER GAUGE

- Cam belt tension gauge provides an exact tension measurement on any timing or accessory belt, on any vehicle.

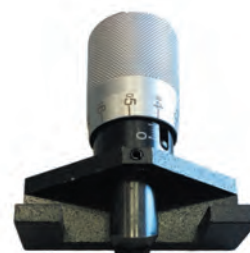

53769

178,00€



ENGINE TIMING LOCKING TOOLS SET FOR RENAULT/NISSAN/OPEL/VOLVO

APPLICATIONS	<p>RENAULT: AVANTIME, CLIO, ESPACE, KANGOO, LAGUNA, MASTER, MEGANE, MODUS, SCENIC, TWINGO, TRAFFIC. OPEL/VAUXHALL: MOVANO, VIVARO. DACIA: DOKKER, DUSTER, LOGAN, SANDERO. NISSAN: ALMERA, INTERSTAR, KUBISTAR, MICRA, NOTE, PRIMERA, QASHQAI. VOLVO: S40, V40</p>
OEM TOOLS	<p>MOT 1312 (1), MOT 1135-01 (2), MOT 1384 (3), MOT 1340 (4), MOT 1543 / KM-6234 / KV113 B0360 (5), MOT 1489 / KV113 B0130 (6), MOT 1536 / KM-6203 (7), MOT 1489 (8), MOT 1054 / KM-6031 / KV113 / B0280 (10), MOT 1318 (11), MOT 910 (12), MOT 910 (14), MOT 1386 (15), MOT 1534 / KM-6205 (16), MOT 1543 / KM-6234 / KV113 B0360 (17), MOT 1543 / KM-6234 / KV113 B0360 (18), MOT 1543 / KM-6234 / KV113 B0360 (19), MOT 1543 / KM-6234 / KV113 B0360 (20), MOT 1386 (22), MOT 1537 / KM-6204 (23), MOT 1348 (24), MOT 1538 (25), MOT 1337 (26), MOT 1496 / MOT 1750 (27), MOT 1490-01 (28), MOT 1200-01 (29)</p>
ENGINE CODES	<p>PEROL: 2.0 16V, 2.5 20V, 1.4, 1.6 16V, 1.8, 2.0 16V, 1.2, 1.7, 1.8, 2.0 16V, 2.2 GASOIL: 1.9, 2.5, 2.8</p> <p>D4F702/706/708/712/714/716/722/728/730/740/764, D7F700/701/710/720/722/726/730/744/746/764/766, E7F700/704/706/750, E7J601/624/626/634/635/680/700/706/710/711/716/718/719/720/724/726/728/740/742/745/754/756/757/764/770/771/773/780, F3P670/682/700/704/706/708/710/712/714/720/724/755/758/760, F7P704/722, F3R611/722/723/728/729/750/751/752/791/796/797/798, F5R700/701/740, J7R732/733/734/735/768, F7R710/714, J7T600/760/761/762/766/772/780/782, N7Q704/710/711, N7U700/701, K4J700/710/711/712/713/714/715/730/732/740/750/770/780, K4M700/701/704/706/707/708/709/710/711/712/714/716/718/720/724/730/732/734/736/740/742/743/744/745/746/748/750/752/753/754/760/761/762/764/765/766/768/776/782/788/790/791/794/800/801/802/804/812/813/830, K9K700/702/704/706/710/712/714/716/718/722/724/728/729/732/734/740/750/752/760/762/764/766/768/802/804/806, F9Q610/650/664/670/674/71/716/717/718/720/722/730/731/732/733/734/736/738/740/744/748/750/752/754/758/759/760/768/762/770/772/774/780/782/784/786/788/790/799/800/803/804/808/812/816/818/820, G9T600/605/700/702/703/706/707/710/712/720/722/742/743/750, G9U720/724/726/730/750/754, F8M736/760, F8Q600/610/606/620/622/624/630/632/640/644/646/648/662/672/678/680/682/684/692/696/706/714/720/722/730/732/740/742/744/764/768/706/776/784/786/788, J8S620/621/622/758/760/776/778, G8T714/716/740/752/760/790/792/794, S8U720/722/730/731/742/748/750/752/770/772/780/782, S9U700/702/704/714/740, S9W700/702/206/208/212, E5F, E6J, K7M, F4P/F4R, FIN, F2N, F3N, F2R, F3P, F4P, F3R, J5T, J6R, J7R</p>

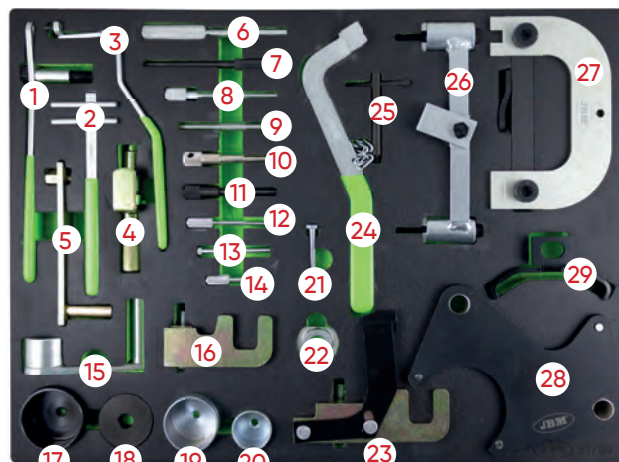

53773

298,00€



ENGINE TIMING LOCKING TOOLS SET FOR FIAT/ALFA/LANCIA/OPEL/SUZUKI/FORD

APPLICATIONS	<p>ALFA: ROMEO 145, 146, 147, 155, 156, 159, 166, SPIDER, GTV, TS, GT, CROSSWAGON Q4 FIAT: PUNTO, GRANDE PUNTO, BRAVA, BRAVO, MAREA, WEEKEND, STILO, DOBLO, CARGO, IDEA, PANDA, MULTIPLA, PALIO, STILO, 500 LANCIA: LYBRA, YPSILON, THESIS, MUSA OPEL: CORSA, AGILA, MERIVA, COMBO, VECTRA, ZARA, ASTRA, INSIGNA, SIGNUM 19 CDTI SUZUKI: IGNIS, SWIFT, WAGON R+ FORD: KA</p>
OEM TOOLS	<p>1860874000 (1), 1860874000 (2), 2000004400 / 2190754400 (3), 1860863000 (4), 1860898000 (5), 2190754500 (6), 2000004300 (7), 1870900400 (8), 1860703000 (9), 1860933000 (10), 1860845000 (11), 1870900300 (12), 1860905000 / EN-46788 (13), 1895443000 (14), 1860992000 (15), 1870896900 (16), 1860987000 (17), 1860905000 (18), 1860771000 (19), 1860161000 (20), 1860876000 (21), 1860876000 (22), 1871000900 (23), 1860985000 (24), 2000004200 / 2190754200 (25), 1860965000 (29)</p>
ENGINE CODES	<p>176B9.000, 182B2.000, 188A5.000, 843A1.000, 323.02, 371.01, 182B4.000, 182B9.000, 186A6.000, 188A2.000, 188A7.000, 188B2.000, 192A1.000, 192A3.000, 937A2.000, 939A1.000, 192A5.000, 192B1.000, 198A5.000, 937A5.000, 939A2.000, 325.01, 342.02, 362.02, 185A6.000, 841C.000, 841G.000, 939A3.000, 940A3.000, 940A4.000, 940A5.000, Z19DT/DTH/DTR/DTJ/DTL, 169A1.000, 955A4.000, 350A3.000, 192B4.000, 198A2.000, 350A2.000, 955A3.000, 192A8.000, 198A6.000, 198A3.000, 199B1.000, 199B2.000, 199A2.000, 199A3.000, 199A9.000, 188A3.000, 188A8.000, 188A9.000, 192A9.000, 186A8.000, 186A9.000, 199A5.000, 223A7.000, 223A9.000, 841H.000, 841P.000, 185A2.000, Z13DT, Z13DTJ, Z13DTH, 182A4.000, 182A6.000, 182B6.000, 178B3.000, 186A3.000, 186A4.000, 350A1.000, 169A4.000, 188A4.000, 199A4.000, 199A7.000</p>

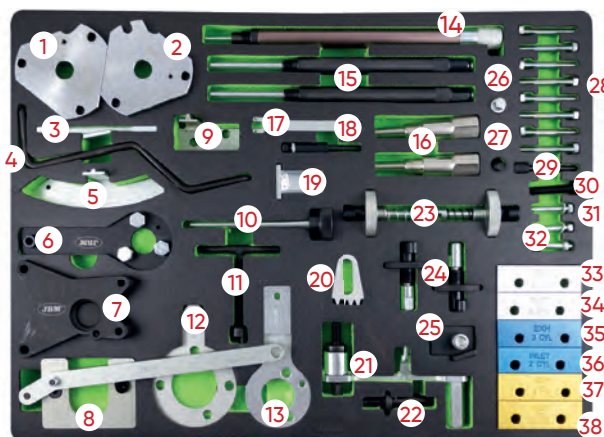

53770

198,00€

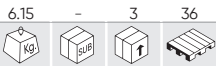

ENGINE TIMING LOCKING TOOLS SET FOR FORD/SEAT/VOLKSWAGEN/MAZDA/VOLVO

APPLICATIONS	FORD: FIESTA, FUSION, COURIER, ESCORT, FOCUS, FOCUS C MAX, PUMA, MONDEO, SIERRA, COUGAR, GALAXY, C-MAX, ORION, TOURNEO CONNECT, TRANSIT, TRANSIT CONNECT. VW: SHARAN. SEAT: ALHAMBRA. MAZDA: I21. VOLVO: S40, V50.
OEM TOOLS	303-1061 (1), 303-1054 (2), 23-059 / 310-085 (3), 21-105 (4), 323-029 (6), 0194-B / 21-263 / 303-735 / 49 JE 02 021 (7), 0132-AB / 0178-D / 21-151 (9), 0194-C, 21-262, 303-734, 49 JE 02 020 (10), 21-238 / 303-679A / 303-1151 (11), 21-238 / 303-679A / 303-1151 (12), 303-1054 (13), 303-1151 (14), 21-238 / 303-679A (15), 303-393 / 303-393-02 (16), 303-1097 (17), 21-168 / 303-393 (18), 303-0985 (20), 2064 / 23-047 / 310-055 / U20003 (21), 303-652 (22), 21-229, 303-651 (23), 303-748 (24), 21-210 (25), 21-260, 303-732 (26), 21-163, 303-620 (27), 21-234 / 21-251 (28), 303-675 / 303-698 (29), 21-104 / 303-193 (30) / 21-162B / 303-367 / 303-376 (31), 21-162B / 303-376 / 303-376B (32), 23-019 (33), 23-058 / 310-084 (34), 0153-M / 0178-C / 0178-D (35), 0178-B / 5711-TB (36), 21-123 (37), 23-020 (38), 21-234 / 21-251 (39), 303-1059 (40), 23-019 (41), 303-1060 (42), 303-393 / 303-393-01 (43)
ENGINE CODES	FUJA, FUJB, FXJA, FXJB, FYJA, FYJB, F8JA, F8JB, M7JA, M7JB, DHA, DHB, DHC, DHD, DHE, DHF, DHG, FHA, FHE, LIT, LIV, LIE, LIG, LIH, LIK, RDA, RDB, RKC, RQB, RQC, FXDA/C, FXDB/D, FYDA/C, FYDB/D, FYDH, HWDA1Z, AHU, AVG, AFN, D24, D24T, D24TIC, RFN, RTJ, RTK, RVA, RFK, RKD, B4164S3, DV4TD (8HW/8HX/8HZ), DV4TED4(8HV/8HY), DV6ATED4 (9HX/9HY/9HZ) F6JA, F6JB, F6JC, G8DA, G8DB, KKDA, SNJA, SNJB, STJA, STJB, ASDA, ASDB, FXJC, SPJA, SPJC, FYJC, HWDA, HWDB, SHDA, SHDB, SHDC, JQDA, LQDB, JTDA, JTDB, HXDA, HXJA, HXJB, IQDA/B, IQDB, PNBA, PNDA, RHBA, SIDA, F6JD, TZJA, TZJB, HHDA, HHDB, HHJA, HHJC, HHJD, HHJE, HHJF, RTA, RTB, RTC, RTD, RTE, RTF, RTH, RTJ, RTK, RFN, BHPA, HCPA, HCPB, KKDA, P7PA, P9PA, P9PB, R2PA, R3PA, RWPA, RWPC, F9DA/B, FFBA, FFWA, KHBA, QYBA, QYWA, KKDB, C9DC, RVA, 1Z, AFN, AHU, ANU, AUY, G6DA, G6DB, G6DC, G6DD, G6DE, G6DF, G6DG, UFDB, TXDB, TYDA, UKDB, QXBA, AZBA, KLBA, QXBB, LPBA, AZBC, TYBA, UKBA, UFBA, TXBA, IXDA, QXWA, QXWB, AZWA, KLWA, AZWC, TYWA, UKWA, TXWA, UFWA, UFDA, TXDA, UKDA, Q4BA, KNBA, 4BA, 4BB, 4BC, 4CC, 4FA, 4CA, 4CB, 4DA, 4EA, 4FA, 4FB, 4FC, 4FD, 4GA, 4HB, 4HC, 4EB, 4EC, 4ED, 4GA, 4GB, 4GC, 4GD, 4GE, 4GF, 4HA, 4HD, FMBA/B, D5BA, ABFA, D3FA, D6BA, HJBA/B, F3FA, D2FA, D4FA, F4FA, F1FA, DOFA, QJBA, QJBB, QJBC, QJBD, FXFA, H9FA, H9FB, N7BA, N7BB, MZ-CD 1.6, Y6

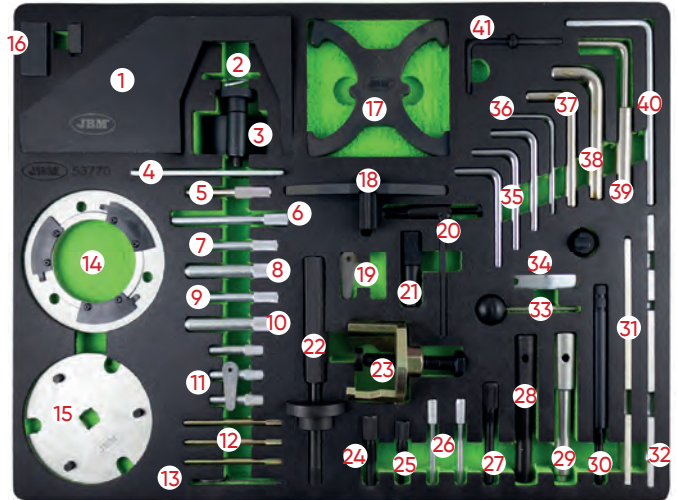

53774

190,00€



ENGINE TIMING LOCKING TOOLS SET FOR OPEL/CHEVROLET/SAAB/FIAT/LANCIA/SUZUKI/FORD

APPLICATIONS	ALFA: 145, 146, 147, 156, 159, 166, GT, CROSSWAGON Q4 FIAT: PUNTO, GRANDE PUNTO, BRAVO, BRAVA, MAREA WEEKEND, STILO, DOBLÒ, CARGO, MULTIPLA IDEA, PANDA LANCIA: YPSILON, MUSA, LYBRA, THESIS OPEL: CORSA B/C, COMBO, TIGRA, AGILA, TIGRA B, MERIVA, ASTRA F/G/H, ASTRAVAN, SPEEDSTER VX220, ZAFIRA A/B, VECTRA B/C, SIGNUM, OMEGA B, SINTRA, FRONTERA A/B, ASTRAVAN, KADETT, ASCONA, OMEGA, MONTEREY, ANTARA, CROMA, SPEEDSTER VX220 SUZUKI: IGNIS, SWIFT, WAGON R+ FORD: KA CHEVROLET & DAEWOO: EPICA, CAPTIVA, NUBIRA, LACETTI, EVANDA SAAB: 9-3, 9-5 (98-04)
OEM TOOLS	1860905000 / 1860905010 / EN-46788 (1), KM-6148 (2), KM-6148 (3), 1870900400 / 1871000200 (4), KM-954 (5), KM-J-43651 (6), 1860905000 / 1860905010 / EN-46788 (7), KM-852 (8), KM-853 (9), 1870900300 / 303-1468 (10), EN-46785 / KM-951 (11), KM-932 (12), 1860703000 (13), KM-955 (14), KM-6130 / KM-6349 / KM-6349 (15), KM-927 (16), EN-48245 (17), KM-933 (18), EN-46785 (19), 1860985000 / 1871000900 / EN-46781 (20), 1860985000 / 1871000900 / EN-46781 (21), EN-48246 (22), KM-929 (23), 1870896900 / EN-46789 (24), KM-952 (25), 21-162B / 303-376 / 303-376B (26), KM-933 (27)
ENGINE CODES	X14XE, Z14XE, X16SEJ, X16XE, X16XEL, Y16XE, Z16XE, Z16YNG, C18XEL, X18XE, X18XE1, Z18XE, Z18XEL, C20SEL, C20XE, X20XEV, Z20LEH, Z20LEL, Z20LER, Z20LET, X22SE, X22XE, Y22SE, Y22XE, Z22XE, D223L, X10XE, Z10XE, Z10XEP, X12XE, Z12XE, Z14XEP, X20DTL, X20DTH, X22DTH, Y20DTL, Y20DTH, Y22DTH, Y22DTR, 169A1.000, 955A4.000, 350A3.000, 192B4.000, 198A2.000, 350A2.000, 955A3.000, 192A8.000, 198A6.000, 198A3.000, 199B1.000, 199B2.000, 199A2.000, 199A3.000, 199A9.000, 940A3.000, 188A3.000, 939A2.000, 188B2.000, 188A8.000, 188A9.000, 323.02, 371.01, 937A2.000, 182B4.000, 182B9.000, 188A2.000, 188A7.000, 192A9.000, 186A6.000, 186A8.000, 192A1.000, 192A3.000, 192B1.000, 192A5.000, 186A9.000, 939A1.000, 199A5.000, 223A7.000, 223A9.000, 342.02, 362.02, 84TG.000, 84TH.000, 84IP.000, 939A3.000, 185A2.000, 185A6.000, Z13DT, Z13DTJ, Z13DTH, Z19DT, Z19DTH, Z19DTJ, Z19DTL, X10XE, Z10XE, Z10XEP, Z12XE, Z14XEP, X16SZR, Z16SE, 4EC1/T, 4EC1, 4EE1/T, 4EE1, X17DT, Y17DT, Y17DTI, Y17DTL, 16DA, 17D, 17DR/X, 7DTL, X17DTL, 4JX1/4, JG2T, 4FC1/T, 4FD1, X20DTL, Y20DTL, D223L Z20DMH, Z20DM, RA420, Z20S1, 194A1.000, Z22SE, Z22YH

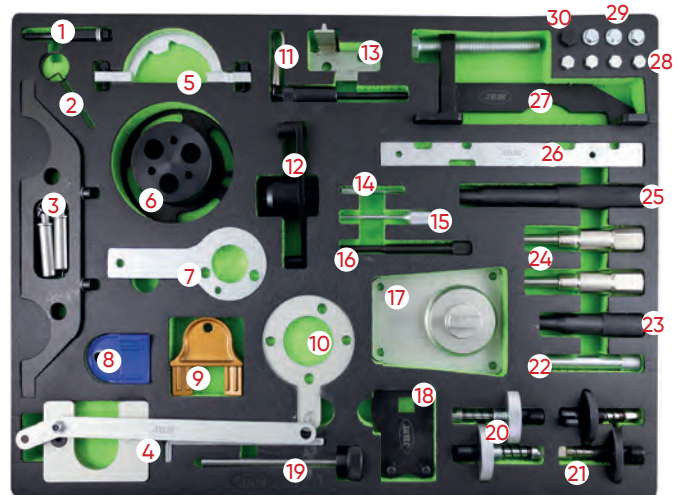

53771

158,00€



ENGINE TIMING LOCKING TOOLS SET FOR FIAT/FORD/CITROËN/PEUGEOT

APPLICATIONS	<p>FIAT: ULYSSE, SCUDO, DUCATO LANCIA: ZETA, PHEDRA FORD: FIESTA, FUSION, FOCUS, FOCUS C-MAX CITROËN: C15, C1, C2, C3 PLURIEL, C4, C4 PICASSO, C5, C6, C8, DS3, DS4, DS5, XANTIA, XSARA, XSARA PICASSO, EVASION, BERLINGO, JUMPY, JUMPER, SAXO, ZX, XM, EVASION, AX PEUGEOT: 107, 1007, 206 CC, 207, 208, 306, 307 CC, 308, 406, 407, 508, 607, 806, 807, PARTNER, EXPERT, BOXER, 206, 106, 605, 205, 405</p>	
OEM TOOLS	<p>4200-TH (1), 0117-AR (2), 0188-X (3), 0606-A1.A2 (4), 0188-Q2 (5), 0189-S1 (6), 7017-TR (7), 0132-P / 4507-TL (8), 0189-C (9), 0188-J1 (10), 0188-J2 (11), 0178-E (12), 0189-R (13), 0132-AK / 0188-AK / 0189-K / 0153-AK / 4533-TAD / MOT 1436 (14), 0188-AH (15), 0189-S2 (16), 0153-AB / 9041-TZ (17), 0153-M / 0178-C / 0178-D / 7014-TM / 9767-94 (18), 0189-A (19), 4527-TS1 (20), 0153-AB / 9041-TZ (21), 0189-B / 21-163 (22), 0132-AJ1 / 0153-G / 0188-M / 0189-J / 4533-TAC1 / 5711-TA (24), 0189-L (25), 0188-D / 7017-TM (26), 0132-X / 0188-Q1 / 4507-TJ / 9767-89 (27), 0194-B (28), 0132-AB / 0194-A (29), 0194-C / 21-262 / 303-734 (30), 4527-TS2 (31), 0188-E (32), 0153-A / 6012-T / 9765-54 (33), 0134-AF / 0134-Q / 0188-F / 9004-T (34), 0188-P2 / 0188-P / 174 / 7015-T (35), 0153-U 7019-T (36), 0153-N / 0188-Y / 7014-TJ / 7099-TM / 9797-34 (37)</p>	
ENGINE CODES	<p>F6JA, F6JB, F6JC, G8DA, G8DB, HHDA, HHDB, HHJA, HHJB CITROËN, PEUGEOT: 1.0 / 1.1 / 1.4 / 1.6 / 1.6 16V, 1.4 / 1.6HDI / 1.8 / 1.8 16V / 2.0 / 2.0 TURBO, 1.9D / 2.0HDI / 2.2HDI / 1.8 16V / 2.0 16V TU9 (CDY/CDZ), TU1 (HDY/HDZ/HFX/HFY/HFZ), TU3 (KDX/KDY/KDZ/KFX/KFZ), TU5JP4 (NFU/NFX), TU5 (BDY/BFZ/NFT/NFV/NFW/NFY/NFZ), XU7 (LFW/LFX/LFZ), EW7J4 (RLZ), XU7JP4 (LGY), XU10 (RFL/RFU/RFW/RFX/RGX/RGY), XU10JP4 (RGX/RGY), EW10A (RFJ), EW10J4S (RFK), EW10D (RLZ), EW12J4 (3FZ), ET3JE (KFU), TU3A/JP (KFV/KFW), DV4TD (8HW/8HX/8HZ), DV4TED4 (8HV/8HY), DV6ATED4 (9HX/9HY/9HZ), EW10-CVI (RLZ), EW12 (3FZ), DW8 (WJZ/WJY), DW10 (RHY/RHV/RHZ/RHS/RHM/RHW/RHT/RHR/RHX), DW12 (4HX/4HZ/4HW/4HY), EW7J4 (6FZ), EW10J4 (RFR), EW10J4D (RLZ), DW12TED4 (4HW), DW10ATED (RHT/RHV/RHW/RHX/RHZ) FORD 1.4 / 1.6 DURATORQ TDCI</p>	

53772

229,00€



ENGINE TIMING LOCKING TOOLS SET FOR FORD/VAG/MAZDA/VOLVO

APPLICATIONS	<p>AUDI: 80, A1, A2, A3, S3, A4, A5, A6, TT, Q5 SEAT: AROSA, IBIZA, CORDOBA, LEON, TOLEDO, ALHAMBRA, ALTEA, INCA (99-04) SKODA: FABIA, OCTAVIA, SUPERB VW: LUPO, POLO, FOX, GOLF, BORA, JETTA, GOLF PLUS, PASSAT, BEETLE, TOURAN, SHARAN, CADDY, CADDY MAXI, TRANSPORTER, GOLF VI CABRIO, TIGUAN FORD: GALAXY</p>	
OEM TOOLS	<p>T10252 (1), VAS6079 (2), T10121 (3), MP1-1312 / T10098 / T20038 / T20038 (4), T10123 (5), 23-058 / 310-084 / T10008 (6), 2065A / T10008 / U40021 (7), 3418 (8), T10171 (9), 23-059 / 23-059 / 310-085 / T10050 / T10050 (10), 3458 / T30094 (11), T10016 / T10074 / T10074 (12), T10100 (14), T10414 (15), 3366 / T20018 / T20044 (16), 3411 (17), 3369 / T30092 (18), T10341 (19), 3242 / T40069 / T30052 (20), T 40026 (21), 3359 / MP1-301 / T20102 (22), 2064 / U20003 (23), T10120 (24), MP1-1312 / T10098 / T20038 (25), T10170 (26), T00115 / T10264 / T40098 (27), T10092 (28), T00115 / T10264 / T40098 (29), 303-1054 / T10115 (30), T10060 / T10060A (31), 3359 / MP1-301 / T20102 (32), T10340 (33), 2587 (34), 3387 / U30009A (35), 3387 / T10020 (36)</p>	
ENGINE CODES	<p>ARC, ATN, AUS, AVY, AZD, AFH, BCA, AJV, AKQ, AUA, AUB, AXP, AFH, AFN, AFK, AHW, AHU, APE, AQQ, AUS, AXP, AZD, BBY, BBZ, BCB, ANY, AYZ, AMF, ATL, BAY, BHC, BMS, BNM, BNV, BWB, AJM, AMG, ANU, ARL, ASZ, ATD, ATJ, AUJ, AVB, AVF, AVQ, AWX, AXB, AXC, AXR, BEW, BJB, BKC, BKE, BLS, BLT, BMT, BPX, BRB, BRM, BRR, BRU, BSU, BSV, BTB, BUK, BVK, BXE, BXF, AZV, BDJ, BDK, BGW, BHW, BKD, BKP, BLB, BMA, BMM, BMN, BMP, BMR, BNA, BPW, BRC, BRE, BRF, BRT, BUZ, BE, BVF, BVG, BVH, BWK, BTS, BMY, BLF, BWV, AZV, BKD, AWY, AZQ (55 - 64 PF), AXU, BAG, BKG, BLF, BLN, BLP, BVF, BKF, BNU, BVP, BVR, IZ, CBZA, CBZC, CBZB, CAXA, CAGA, CAGB, CAGC, CAHA, CAYA, CAYB, CAYC, CBAA, CBAB, CBAC, CBBA, CBBB, CBDA, CBDB, CBDC, CBEA, CEGA, CKUB, AZV, BDJ, BHP, BKD, BLB, BMA, BMM, BMN, BMP, BMR, BNA, BPW, BRC, BRE, BRF, BRT, BSS, BUJ, BUZ, BVA, BVE, BVF, BVG, BVH, BWA, ACV, AFB, AGX, AHD, AHY, AHY, AJT, AKE, ANJ, APA, AUF, AXG, AXG, AXL, AYC, AYM, AYY, BAU, BBE, BBF, BCZ, BDG, BDH, BFC, BJJ, BJK, BJL, BJM</p>	

TIMING TOOLS

7 DRAWER TOOL TROLLEY - TIMING TOOL SET INCLUDED

53951 1.794,00€

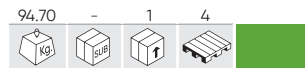

FULL

53952 1.794,00€

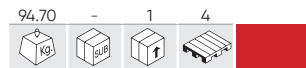

FULL

54501 1.794,00€



FULL

54502 1.794,00€

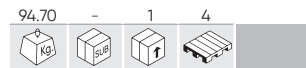

FULL

INNER MEASURES

SMALL DRAWERS (X5)



BIG DRAWERS (X2)



DRAWER LOADING CAPACITY: 30KG.
TOTAL LOADING CAPACITY: 70KG.

TOLL TROLLEY MEASURES

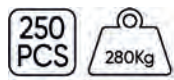

EVA TOOL SETS:

6 PIECES TIMING TOOL SET

53775 1.109,00€



GASOLINA/PETROL

DIESEL/GASOIL

IT CONTAINS

REF.	Kg	SUB	1	6	€
53769	5.90	-	3	36	178,00€
53770	6.15	-	3	36	198,00€
53771	4.05	-	3	36	158,00€
53772	6.40	-	3	36	229,00€
53773	6.60	-	3	36	298,00€
53774	6.95	-	3	36	190,00€

53769



RENAULT / NISSAN / OPEL / VOLVO

53770



FORD / SEAT / VOLKSWAGEN / MAZDA / VOLVO

53771



FIAT / FORD / CITROËN / PEUGEOT

53772



FORD / VAG / MAZDA / VOLVO

53773



FIAT / ALFA / LANCIA / OPEL / SUZUKI / FORD

53774



OPEL / CHEVROLET / SAAB / FIAT / LANCIA / SUZUKI / FORD

FOR FURTHER INFORMATION

PAGE 297

ACCESSORIES AND SPARE PARTS

PAGE 90

300 VAT not included



www.jbmcamp.com

LUBRICANT ACCESSORIES

- 302 DIESEL FUEL SUPPLY PUMPS
- 303 UREA SUPPLY PUMPS
- 304 EXTRACTION/FILLING PUMPS
- 307 OIL COLLECTORS
- 308 SUCTION GUNS
- 309 OIL COLLECTOR BUCKETS
- 310 OTHERS



53697

398,00€



DIESEL TRANSFER PUMP SYSTEM WITH DISPENSING NOOZLE AND METER (200V-240V)



- Rated Voltage: 220V±10% 50HZ.
- Rated Power: 550W.
- Max. Flow: 20-65L/min.
- Cable length: 2m.
- Suction hose length: 2m.
- Supply hose length: 4m.

WITH AUTOMATIC STOP



SPARE PARTS AVAILABLE

53610

294,00€



DIESEL TRANSFER PUMP WITH DISPENSING NOOZLE (230V)



- Inlet hose length: 2m.
- Outlet hose length: 4m.
- Electric pump.
- Hoses and gun supplied.

WITH AUTOMATIC STOP



SPARE PARTS AVAILABLE

53609

182,50€

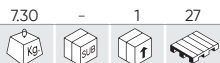

DIESEL TRANSFER PUMP WITH DISPENSING NOOZLE (12V)



- Inlet hose length: 2m.
- Length of the outlet hose: 4m.

WITH AUTOMATIC STOP



SPARE PARTS AVAILABLE

54100

265,00€



DIESEL ELECTRIC PUMP



- Flow of up to 18.4 liters per minute.
- Flow: 18.4LPM (4.86GPM)
- Suction tube length: 850-1245mm
- Hose length: 2m
- Working temperature: 5° - 40°C (41° to 104°F)
- DC Voltage: 12V
- Alternating current: 100-240V
- Cable length: 4m



53645

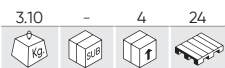

ELECTRIC PUMP FOR UREA AUS32



- Electric pump designed for water based media, Urea AUS32 DEF & select chemicals from metal drums of 205L or 1000-1250L IBC'S.
- Compact & lightweight construction.
- Built-in fuse for overload protection and silent motor.
- Stainless Steel filter built into the suction tube inlet preventing contaminants from getting in and causing damage.

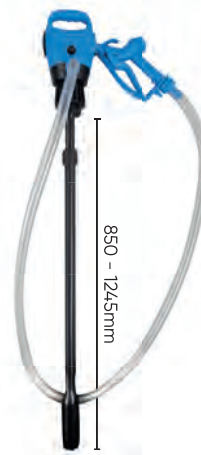

268,00€



SPARE PARTS AVAILABLE

53644

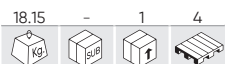

UREA AUS32 TANK (75L)

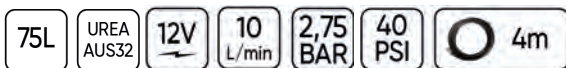

- A free standing and fully mobile 75L with a 12V powered pump (capable of delivering up to 10lit/min), hose and auto shutoff valve.
- Made of polyethylene which is impact, corrosion and UV resistant.
- The large diameter wheels (200mm) allow it to be easily moved over workshop.



1.238,00€



15631

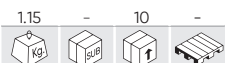

AUTOMATIC NOOZLE FOR UREA AUS32 SUPPLY (REF.53645)



98,00€

52329



PLASTIC LEVER PUMP



- Drum 25, 50, 200L.
- 350ml pump.
- Body and piston of polypropylene.
- Handle plastic ABS.
- Applications: Alcohol, oil, lubricants, gasoline, diesel, kerosene, etc.
- Suction line:
 - Minimum width: 320mm.
 - Maximum length: 900mm.



36,40€



13982



LEVER PUMP THREAD ADAPTER

- Allows to adjust and compensate the different threads of drums, barrels and pumps.



4,00€

52601

397,00€

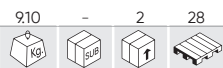

200L

AIR-OPERATED OIL PUMP KIT + HOSE WITH DISPENSING GUN

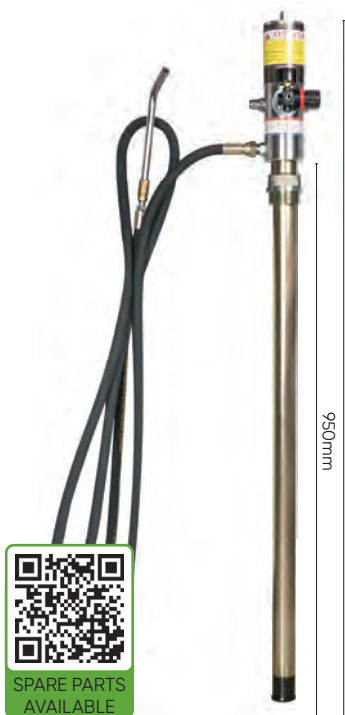

- Ratio Pressure: 5: 1.
- Air inlet: 1/4".
- Air outlet: 1/4".
- Working Pressure: 6-8 bar.
- Max. Pressure: 8 bar.
- Air consumption: 250 L/min.
- Relative capacity at 6 bar: 18 L/min.
- Oil temperature range: -10-50 °C.
- Maximum viscosity: 240 SAE.
- Tube length: 950 mm.

50918

341,00€

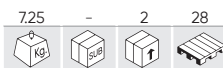

200L

AIR-OPERATED OIL PUMP

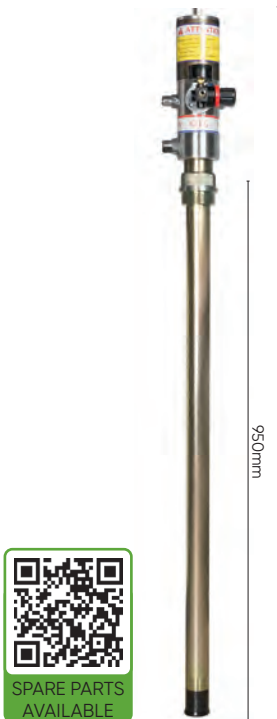

- Ratio Pressure: 5: 1.
- Air inlet: 1/4".
- Air outlet: 1/2".
- Working pressure: 6-8 bar.
- Max. pressure: 8 bar.
- Air consumption: 250 L/min.
- Relative capacity at 6 bar: 18 L/min.
- Oil temperature range: -10-50 °C.
- Maximum viscosity: 240 SAE.
- Tube length: 950 mm.

50935

595,00€

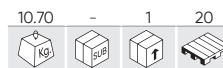

200L

AIR-OPERATED OIL PUMP KIT + DIGITAL HOSE END METER



- Air consumption: 250 L/min.
- Relative capacity at 6 bar: 18 L/min.
- Oil temperature range: - 10-50 °C.
- Maximum viscosity: 240 SAE.
- Ratio Pressure: 5: 1.
- Air inlet: 1/4".
- Air outlet: 1/2".
- Working pressure: 6-8 bar.
- Max. pressure: 8 bar.
- Hose length: 2 m.
- Tube length: 950 mm.

53566

32,00€

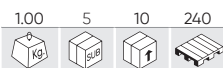

OIL TRANSFER PUMP 12V



- Oil pump ideal for quick and clean oil-changes.
- It works by connecting the clamps to the 12V car battery.
- The oil is simply drawn out the motor through the oil dipstick bore.
- Useful for motor oil, diesel oil or heating oil.



51253 41,00€

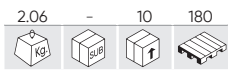

LEVER PUMP

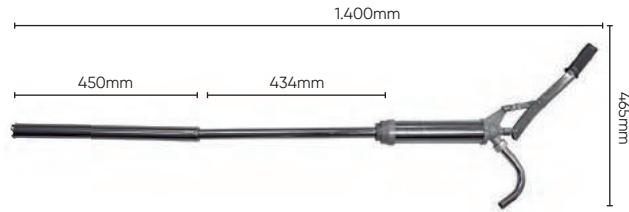

52428 40,00€

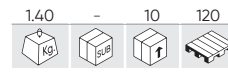

ROTARY PUMP

- Drum 50 and 200L.
- Vol. 400ml.
- Capacity pump: 32L x 60 seconds.
- Adaptor 2" included.
- Suction pipe 101cm with entrance 1 1/4" exit 1".
- Not allowed for: strong acid, bleaches, gasoline.
- Applications: oils, lubricants, diesel, oil-based fluids.
- Recommended for: antifreeze, brake fluid, detergents, glycerine, mild acids, oil-based fluids.
- Not allowed for: strong acid, bleaches, gasoline.



50917 271,00€

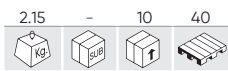

DIGITAL HOSE END OIL METER WITH PIPE

- Air inlet: 1/2" BSPF
- Flow rate: 1-35 L/min
- Working Pressure: 6-8 bar
- Max. working pressure: 100 Bar
- Oil temperature range: -10-60 °C
- Maximum viscosity: 240 SAE
- Battery: 2x1.5V (battery included)
- Flow meter accuracy: ±0.5%
- Flow meter repeatability: 0.2%
- Discharge Rate per Revolution: 25ml/R



53627 22,50€

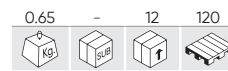

OIL AND FUEL EXTRACTION KIT

1,6L Designed and manufactured to provide for quick and easy removal of oil, gas, and transmission / differential fluids from the reservoirs of generators, pressure washers, air compressors, lawn and garden tractors, or ATV's.



REF.	DESCRIPTION	kg	units	€
10000	MEASURING DIGITAL SYSTEM FOR 50917	2.10	-	7,00€

52797 198,00€

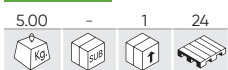

7,5L TRANSMISSION OIL FILLING SYSTEM

- Capacity: 7,5L.
- Hose: 80cc cycle.
- Viscosity range: SAE 140.
- Allows filling and emptying



REF.	DESCRIPTION	kg	units	€
13234	TRANSMISSION OIL FILLING SYSTEM WITHOUT ACCESSORIES (FOR REF. 52797)	3.75	24	224,50€

12044 147,00€

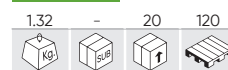

ADAPTORS SET FOR TRANSMISSION OIL FILLING SYSTEM (15 ACCESORIES)

- ATF101: FORD 1/8 - 27 (NPT).
- ATF102: Universal BMW, Honda, Nissan, etc.
- ATF103: VW/Audi. Skoda.
- ATF104: VW/Audi. Porsche.
- ATF105: VW/Audi, Mini cooper M10x1.0
- ATF106: VW/Audi DSG M24 x 1.5
- ATF107: VW/Audi CVT M22x1.5
- ATF108: Mercedes M12 x 1.5
- ATF109: V/W. Skoda M18x1.5
- ATF110: Audi/VW, Skoda M30x1.5
- ATF111: Universal flexible 300mm. Honda. Hyundai. KIA...
- ATF112: Volvo 5/16 - 24 (UNF)
- ATF113: Toyota, Lexus M18 x 1.5
- ATF114: Nissan, Infinity M8 x 1.0
- ATF115: ATF-Adapter VW Passat



54290

4.307,00€

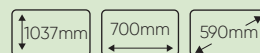

N

AUTOMATIC TRANSMISSION OIL EXCHANGE MACHINE

220V 50hz	150V	-10°C 50°C	40L	2 L/min	Error de intercambio equivalente Equivalent exchange error ±100ml
<90%	0-150 PSI	5µm	<70dB	70kg	

- Automatic filling of transmission fluid
- Automatic identification of the liquid direction (inlet/outlet)
- Automatic cleaning
- Automatic change of new/used liquid.
- Visualization of liquid pressure levels
- Accurate display of transmission fluid temperature
- Intelligent electronic control
- Updatable database
- Includes adapters for different brands
- Improves the performance of the automatic transmission system



VIDEO TUTORIAL



SPARE PARTS AVAILABLE

54367

729,00€



N

SET OF ADAPTORS FOR REF.54290 (105 PCS)

IT CONTAINS



TECHNICAL INFORMATION

54050

895,00€



AUTOMATIC TRANSMISSION OIL EXCHANGE MACHINE

- Power source: 12 V (car battery)
- Pump power: 70 W
- Oil pressure gauge diameter: 70 mm (both oil pressure gauges)
- Oil pressure gauge range: 0-10 bar (0-150 psi) (both oil pressure gauges)
- Fresh oil tank capacity: 30 liters
- Used oil tank capacity: 30 liters



VIDEO TUTORIAL



SPARE PARTS AVAILABLE

53874 398,00€

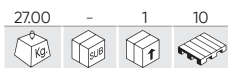

90L MOBILE WASTE OIL DRAINER WITH INSPECTION CHAMBER

90L 8-10 BAR



FOR TRUCKS/VEHICLES

- Air working pressure 8 bar
- Vacuum pressure: negative 0 ~ 0.8 bar
- Tank capacity: 70L
- Collection funnel capacity: 10L
- Measuring glass capacity: 10L
- Oil suction flow rate according to dipstick probe diameter: 0.8L/min (Ø5x3.5mm); 1L/min (Ø6x4.5mm); 1.6 L/min (Ø8x6.5mm)
- Dimensions: 43x49x163cm
- Medium: Engine oil and gear oil
- Recommended working oil temperature: 40 ~ 60°C
- Ocular measurement system.
- Big capacity tank.
- Handle to facilitate manipulation.
- Wheels to facilitate the transport.

53873 285,00€



80L MOBILE WASTE OIL DRAINER

80L 1-3 BAR



FOR TRUCKS/VEHICLES

- Air working pressure 6 bar
- Tank capacity: 70L
- Collection funnel capacity 10L
- Dimensions: 35x48x163cm
- Medium: Engine oil and gear oil
- Big capacity tank.
- Handle to facilitate manipulation.
- Wheels to facilitate the transport.

15084 68,00€



EVA TRAY DRAIN PLUG KEY SET

	x2 5/16", 3/8"		x7 8, 9, 10, 12, 13, 14, 17mm
	x7 7, 8, 10, 11, 12, 13, 14mm		x1 T45
	x1 10mm		x1 M16
	x1 10mm		x1 200mm
			x1 150mm



53215 19,00€



18L FLUID DRAIN PAN

18L



53144 18,00€



18L OIL DRAIN PAN

18L



54051

39,00€



8L PORTABLE OIL DRAIN COLLECTOR

8L PE



51356

48,00€

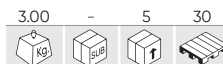

STEEL TRAY FOR LIQUIDS

23L



52498

58,00€



FUEL RETRIEVER



- Made from polypropylene.
- Transparent body.
- Fit for transmissions and differential.
- Resistant to brakes liquid and antifreeze.



52628

26,50€

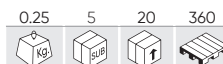

FUEL RETRIEVER



- Useful for brake liquid.
- Quick connector.



REF. DESCRIPTION

11867 O-RINGS REPLACEMENT (X2)FOR REF. 52498

kg	sub	unit	pallet	€
0.02	-	100	-	9,00€

51928

14,00€



OIL SUCTION GUN

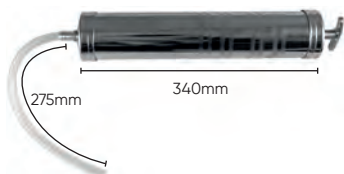

52789

15,20€



EMERGENCY FUEL TRANSFER PUMP



- Hose 90cm long for each end.

50924

342,00€

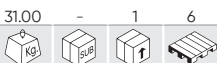

STEEL DRUM HOLDER CART

200L



DRUMBANK SPILL PALLET

52804 343,00€

14.50 - 1 5

230L 400Kg

HOMOLOGATED DIBT
1 VERTICAL DRUM

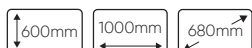

52805 426,00€

13.35 - 1 6

250L 650Kg

HOMOLOGATED DIBT
2 VERTICAL DRUMS



52806 742,00€

17.50 - 1 5

250L 1250Kg

HOMOLOGATED DIBT
NOT SUITABLE FOR PALLETS
4 VERTICAL DRUMS



53214 285,00€

16.50 - 1 12

230L 650Kg

380mm 1310mm 910mm

DRUMBANK SPILL PALLET- 2 VERTICAL DRUM
- SPECIAL FOR EUROPALLET

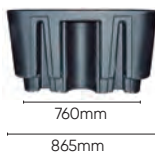
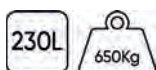

52807 1,714,00€

30.00 - 1 7

1000L 2500Kg

700mm 1680mm 1680mm

DRUMBANK 1000L IBC CONTAINER



HOMOLOGATED DIBT



54498 6,090,00€

221.00 - 1 -

2500Kg

2500mm 1775mm 1770mm

IBC HARDCOVER

Enables the storage of IBC containers. Provides maximum weather protection for the container. With 2 litre capacity liquid collection tray, integrated retention tray and ventilation slots.

1000 LITRE CONTAINER CAPACITY: 1 UNIT

200 LITRE DRUM CAPACITY: 4 UNITS

TOTAL LOAD CAPACITY: 2500KG.



IBC CONTAINER NOT INCLUDED

53612

96,00€

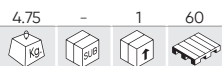

DRUM CLAMP (CAPACITY 500 KG.)



- For easy oil drums handle.
- Max load: 500kg.
- Vertical type of drum grip.
- Special 200L oil drums.



JERRY CAN

REF.	L/mm				€
54181	5L - 550x260x350mm	1.45	4	72	25,10€
54182	10L - 570x350x425mm	2.55	4	48	34,70€
54184	20L - 760x370x500mm	4.10	4	24	44,00€



54183

38,20€



10L ANTI-OVERTURN JERRY CAN



REF. DESCRIPTION

15874 FLEXIBLE FILLING HOSE FOR JERRY CAN (REF.54181, 54182, 54183, 54184)

				€
0.30	-	50	800	6,50€

52452

8,00€



NYLON DRUM BUNG KEY/BUCKET OPENER



- Material: Nylon.
- Anti-spark and anti-dust.
- Sizes 3/4" and 2".
- Useful for 200L.

53078

18,00€

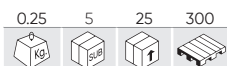

PLASTIC TAP FOR 200L BARREL



- Allows a fast draining of 200l barrels.
- It can be used for water, all kind of oil, alcohol and ketone, as well as weak acid and weak base liquid.
- Material: PE.
- EPDM gasket.
- Stainless steel spring.

53518

3,50€



3/4" PLASTIC BARREL TAP



- Suits all type of liquid.
- 3/4" male thread.

52453

21,00€

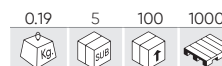

3/4" AUTO-RELEASE LOCKABLE BARREL TAP



- Security Brass.
- Sizes 3/4".
- Body alignment.
- Nylon.
- Applications: oil, libricants, gasoline, diesel, kerosene, etc.
- Valid for Urea AUS32.

52242

12,00€

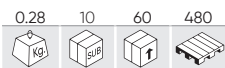

PUMP OILER 500ML

500ml



52243

8,50€

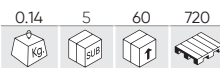

PUMP OILER 0.25L

250ml



52991

10,50€

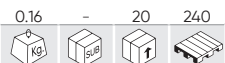

FLASK WITH FLEXIBLE NECK

2L



52992

18,00€



FLASK WITH FLEXIBLE NECK 5L

5L



53187

39,00€

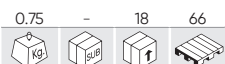

200L BARREL FUNNEL WITH LID AND FILTER

4,5L



- Ø Interior: 245mm.
- Ø Exterior: 255mm.

53188

7,00€



SET OF 3 FUNNELS

Ø 90,130,180mm



52391

5,00€

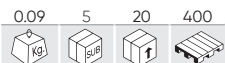

FUNNEL WITH FILTER

950ml



140x15mm



53198

9,50€

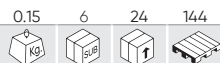

FUNNEL WITH FLEXIBLE HOSE

1,8L



Ø 180mm



53849

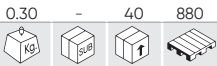

MINI GREASE GUN



16,10€

50852

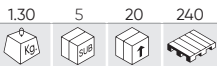

3-WAY SIDE LEVER GREASE GUN



24,50€

50751

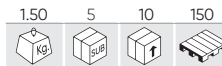

PNEUMATIC GREASE GUN

- Rigid tube
- Flexible tube
- Pressure: 30 Mpa



43,00€

53592

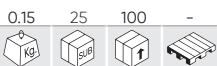

QUICK RELEASE GREASE COUPLER



25,00€

54255

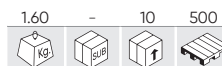

SET OF ACCESSORIES FOR GREASE GUN



68,00€

Recommended to be used with JBM grease guns ref. 50751 and ref. 50852, although it can be used on most hand, battery powered or air grease guns and bulk grease pumps.

60038



CORDLESS GREASE GUN

BATTERY NOT INCLUDED.

This tool has been designed for lubricating purposes and can be easily transported and manipulated wherever thanks to its cordless design.



255,00€

HYDRAULIC TOOLS

- 314 TROLLEY JACKS
- 316 BOTTLE JACKS
- 317 RATCHED JACKS
- 317 TELESCOPIC HYDRAULIC JACK
- 318 CAR JACK STANDS
- 318 OTHERS
- 320 MANUAL PALLET JACK
- 321 PRESSES
- 322 CRANES
- 323 LIFTING TABLES
- 325 RUBBER TAP FOR CAR LIFT



HYDRAULIC TOOLS

53725

248,00€

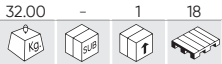

3T HEAVY DUTY TROLLEY JACK - FAST PUMP SYSTEM



MAX: 465mm
MIN: 133mm



SPARE PARTS AVAILABLE

CONFORMS TO: EN 1494:2001

50818

198,00€

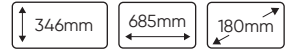
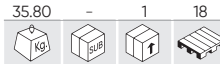

3,5T HEAVY DUTY TROLLEY JACK



MAX: 495mm
MIN: 133mm



SPARE PARTS AVAILABLE

CONFORMS TO: EN 1494:2001

53422

368,00€

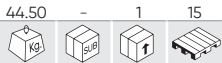

3T HYDRAULIC JACK WITH LIFTING PEDAL



MAX: 533mm
MIN: 100mm



SPARE PARTS AVAILABLE

50815

88,00€

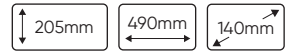

2T HANDCART HYDRAULIC JACK



MAX: 355mm
MIN: 130mm



SPARE PARTS AVAILABLE

53112

298,00€

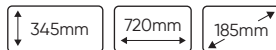

3T TROLLEY JACK WITH PEDAL



MAX: 520mm
MIN: 140mm



SPARE PARTS AVAILABLE

53968

49,00€

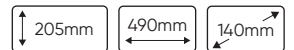

2T HYDRAULIC TROLLEY JACK



MAX: 300mm
MIN: 130mm



SPARE PARTS AVAILABLE

CONFORMS TO: EN 1494:2001

51895 99,00€

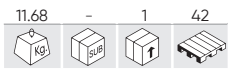

2T HEAVY DUTY TROLLEY JACK IN PLASTIC BOX



↑ MAX: 355mm
↓ MIN: 130mm



SPARE PARTS AVAILABLE

50816 88,00€

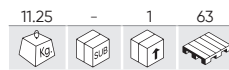

2T HEAVY DUTY TROLLEY JACK - LOW CARS



↑ MAX: 340mm
↓ MIN: 90mm



SPARE PARTS AVAILABLE

53421 298,00€

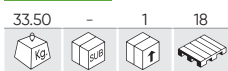

2T HEAVY DUTY TROLLEY JACK - LOW CARS



↑ MAX: 505mm
↓ MIN: 75mm



SPARE PARTS AVAILABLE

54137 288,00€



2,5T HEAVY DUTY TROLLEY JACK - LOW CARS



↑ MAX: 505mm
↓ MIN: 78mm

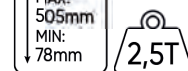

DOUBLE PISTON

MAINTENANCE TUTORIAL



HYDRAULIC JACKS FOR LOW CARS

THEY PROVIDE OPTIMAL ADAPTATION TO LOW PROFILE VEHICLES, THANKS TO THEIR REDUCED HEIGHT AND CURVED DESIGN.

HYDRAULIC TOOLS

BOTTLE JACK

50819 28,00€



MAX: 345mm
MIN: 181mm
2T



50820 34,50€



MAX: 372mm
MIN: 194mm
3T



50821 47,00€



MAX: 413mm
MIN: 216mm
5T



50822 59,00€



MAX: 460mm
MIN: 230mm
10T



52304 84,00€



MAX: 365mm
MIN: 225mm
15T



50823 94,00€

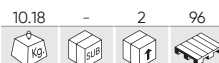

MAX: 452mm
MIN: 242mm
20T



50824 88,00€



MAX: 355mm
MIN: 190mm
20T

LOW CARS



50825 154,00€

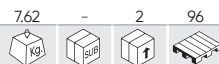

MAX: 465mm
MIN: 285mm
30T



BOTTLE JACK PLASTIC BOX

51905 34,50€



MAX: 340mm
MIN: 185mm
2T



51906 39,00€



MAX: 385mm
MIN: 195mm
3T



51907 48,00€



MAX: 450mm
MIN: 215mm
5T



3T HEAVY DUTY FARM JACK

REF.	Min.	Max.	mm				€
53895	130mm	330mm	510x265x140	9.15	1	42	107,00€
53896	130mm	645mm	840x265x140	11.60	1	28	127,00€
53897	130mm	1045mm	1220x265x140	13.85	1	21	140,00€
53898	130mm	1320mm	1520x265x140	15.65	1	21	148,00€



ACCESSORIES

REF.	DESCRIPTION				€
15093	WHEEL MOUNT BRACKET	3.65	1	50	38,00€
15094	OFF-ROAD BASE	1.35	5	140	39,50€
15095	HANDLE LOCK	0.10	50	-	13,00€
15096	LIFT MATE	2.00	10	560	40,00€



54001

285,00€

28.50	-	1	20

TELESCOPING HYDRAULIC JACK 0,5T

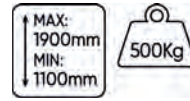

- Lifting range from 116 to 197 cm.
- Double position support.
- Comfortable and fast elevation with pedal.
- Spring valve for controlled decline.
- Allows lifting and moving safely gearboxes, differentials, tanks, etc.



50830

560,00€

52.10	-	1	6

TELESCOPING HYDRAULIC JACK 0,5T



- With handle.
- Double piston.



HYDRAULIC TOOLS

AXLE STANDS SET

REF.	DESCRIPTION						€
53779	3T 290-430mm	5.05	-	1	72		36,00€
53845	6T 370-610mm	9.35	-	1	30		64,00€
54143	12T 500-770mm	35.50	-	1	12		249,00€



54143

198,00€



1,8T AXLE STAND (1220-2146MM)

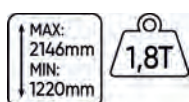

JACK STANDS 10 TON

REF.	DESCRIPTION						€
54145	10T 482-775mm	37.90	-	1	4		377,00€
54146	10T 736-1212mm	2.00	-	1	4		492,00€



54144

298,00€



SET OF 2 JACK STANDS 22 TON (338-500MM)

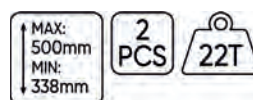

53200

69,00€

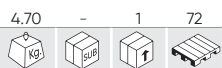

ALUMINIUM JACK STAND 3T

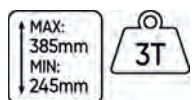

53218

26,00€



SCISSOR JACK 1,5 T

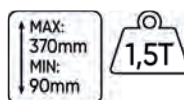

51901

999,00€

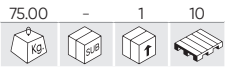

1T CAR TYRE DOLLY



- Length: 1040mm.
- Width: 1090mm.
- Height: 890mm.
- Max. wheel diameter: 1.320mm.
- Working range: 50-100mm.

SPECIAL FOR TRUCKS



54257

318,00€

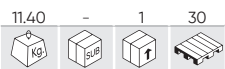

HYDRAULIC HAND PUMP

10000 PSI
3/8" NPT

WORKING PRESSURE:
- Stage 1: 0-20 kg/cm³
- Stage 2: 20-700 kg/cm³

1,8m

FLOW:
- Stage 1: 13cc
- Stage 2: 2.3cc



52241

1.690,00€

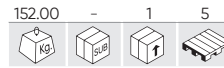

1,5T HEAVY DUTY WHEEL DOLLY FOR TRACTOR TYRES



- Capacity: 1.5T
- Lifting range: 0-770mm
- Total length: 1270mm
- Total width: 990mm
- Total height: 1340mm
- Maximum wheel diameter: 2200mm (86")
- Minimum wheel diameter: 1000mm (39")
- Maximum wheel width: 800mm



50835

290,00€

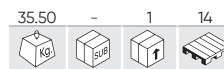

12T HIDRAULIC INDUSTRIAL PIPE BENDER



- Cap. Max.: 12T
- Pressure air: 0,75 - 0,85mpa
- Measure: 68x58,5x18,5cm
- Bending die sizes: 1/2", 3/4", 1", 1-1/4", 1-1/2", 2".

HYDRAULIC TOOLS

53880

598,00€

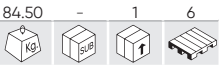

MANUAL PALLET JACK QUICK LIFT

- Capacity: 2500kg
- Push rod length: 1150mm
- Handle: Square handle with Rubber
- Steered wheel: PU (200x50mm)
- Loading wheel: Tandem Pu (80x70mm)
- Min Fork Height: 85mm
- Max Fork Height: 200mm
- Pump Strokes: 8



QUICK LIFT PUMP
(CAST STEEL)



SPARE PARTS
AVAILABLE

54396

2.250,00€

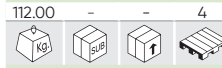

N

ELECTRIC PALLET TRUCK



SPARE PARTS
AVAILABLE



TECHNICAL
INFORMATION

50839

180,00€

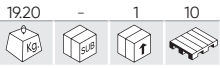

680 KG HYDRAULIC CAR WHEEL DOLLY



SPARE PARTS
AVAILABLE



50923

454,00€

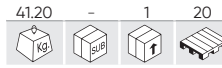

SPECIAL PLATE TRANSPORT CART



SPARE PARTS
AVAILABLE



52514

84,00€

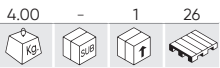

FRONT MOTORCYCLE PADDOCK STAND



SPARE PARTS
AVAILABLE



51751

99,00€

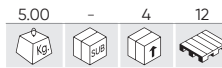

REAR MOTORCYCLE PADDOCK STAND



SPARE PARTS
AVAILABLE



53684

1.880,00€

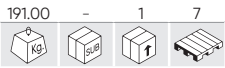

30T PRESS

- Capacity (T): 30.
- Stroke (mm): 160.
- Working range (mm): 166-1126.
- Base width (mm): 540.
- Side Stroke (mm): 200.
- Stroke (mm): 150
- Manual handle and foot pedal.



SPARE PARTS AVAILABLE

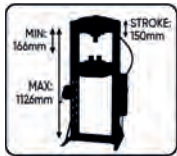

53590

1.190,00€



20T PRESS

- Capacity (T): 20.
- Stroke (mm): 145.
- Working range (mm): 58-1018.
- Base width (mm): 540.
- Inner width (mm): 536.
- Side Stroke (mm): 180.



SPARE PARTS AVAILABLE

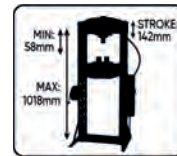

2 VELOCIDADES
2 SPEEDS



REF. DESCRIPTION

14616 GRID GUARD FOR HIDRAULIC PRESS 20T/30T (REF.53590/ 53684)



€

6.30 - 1 - 96,00€



52999

178,00€



HYDRAULIC PRESS SUPPORT BLOCK

BIG BLOCK



SMALL BLOCK



50827

387,00€

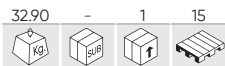

SPRING COMPRESSOR FOR DAMPENERS

- Capacity: 1T (2200 lbs)
- Compressed spring diameter: 200mm
- Compression length: 200-500mm

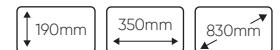

50831

460,00€

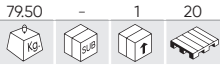

2 TON COLLAPSIBLE CRANE



52985

598,00€

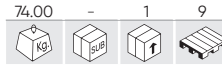

1T COLLAPSIBLE CRANE



50631

68,00€

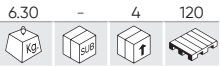

ENGINE LEVELER 750KG



50840

138,00€

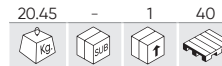

ENGINE GEARBOX SUPPORT 500KG (1750MM)



REF.	DESCRIPTION	Kg	SUB	1	50	€
51452	HOLDER FOR 50840	3.43	-	1	50	69,00€

53682

98,00€

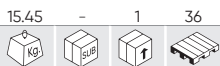

ENGINE GEARBOX SUPPORT 500KG (1480MM)



52055

139,00€

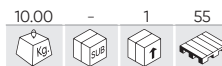

UNIVERSAL ENGINE SUPPORT



50836

148,00€

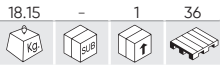

UNIVERSAL ENGINE STAND 340KG



50838

299,00€

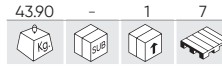

UNIVERSAL ENGINE STAND 900KG



- Folded dimensions:
1000x500x440mm.



STEEL PLATFORM CART

54262

88,00€

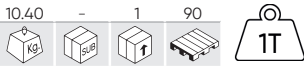

54263

130,00€

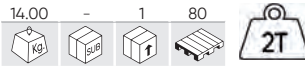

54264

240,00€

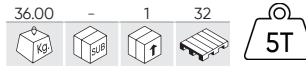

	54262	54263	54264
LIFTING HEIGH	2,8m	2,8m	2,8m
CHAIN FALLS	1	2	2
CHAIN MEASUREMENTS		Load chain: 6x30mm Hand chain: 4,5x25mm	
LENGHT		Load chain: 3m Hand chain: 2,5m	
EFFORT FOR MAXIMUM LOAD	304N	310N	361N
MATERIAL		Load chain: Steel 20Mn2 Hand chain: Steel Q235	



52845

170,00€

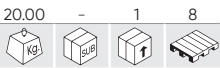

SET OF 2 CAR RAMPS (1 TON)

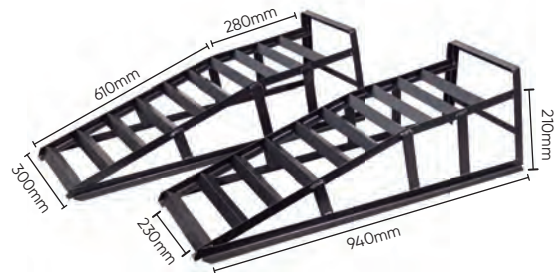

53423

199,00€

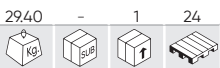

ATV JACK



53969

96,00€

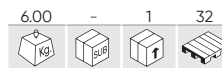

MOTORCYCLE STAND LIFT



54386

5.839,00€

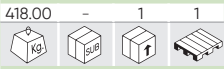

N

ENERGY VEHICLE BATTERY ASSEMBLING LIFT

This hydraulic table for electric vehicle batteries ensures correct and safe handling. It has 6 electrically insulated rubber pads that allow you to work safely with electric vehicle batteries. The height of each of these studs can be adjusted independently. The platform has several rotating keys built in that allow you to adjust the height very precisely. If necessary, you can extend the length of the platform. In addition, it operates with two cylinders to provide faster raising and lowering.

In terms of safety, on the one hand, it has safety teeth that prevent the platform from falling suddenly. On the other hand, it has an automatic protection system that prevents the maximum permitted elevation from being exceeded. It also has two wheels with brakes to ensure that no unexpected movements occur.

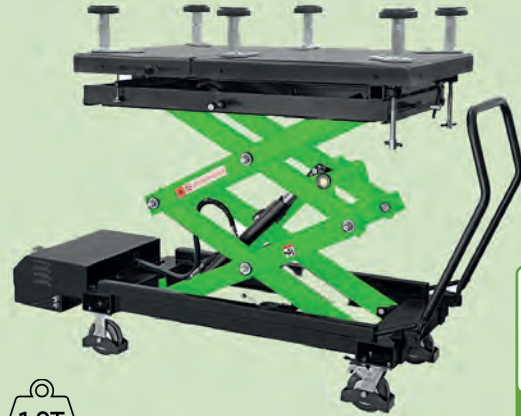

SPARE PARTS AVAILABLE

Loading characteristics	Distributed load
Lifting time (without load)	60"
Lowering time (without load)	45"
Platform	1290 - 1400x768mm

MAX: 1840mm
MIN: 650mm



52692

129,00€

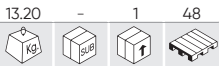

MOTORCYCLE STAND LIFT JACK



50911

788,00€

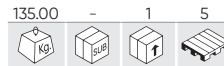

HYDRAULIC LIFT TABLE FOR MOTORCYCLES 365KG



SPARE PARTS AVAILABLE

53246

1.144,00€

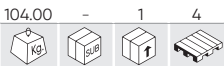

HYDRAULIC LIFT TABLE 360KG



50630

590,00€

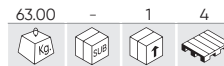

HYDRAULIC LIFT TABLE 400KG



SPARE PARTS AVAILABLE

RUBBER LIFT PAD FOR ELEVATOR

<p>54349 8,00€</p> <p>0.48 - 68 -</p> <p>A 160mm B 120mm C 20mm</p>	<p>54350 12,50€</p> <p>0.67 - 48 -</p> <p>A 160mm B 120mm C 30mm</p>	<p>54351 14,00€</p> <p>0.97 - 32 -</p> <p>A 160mm B 120mm C 40mm</p>	<p>54352 18,00€</p> <p>1.43 - 20 -</p> <p>A 160mm B 120mm C 60mm</p>
<p>54353 23,50€</p> <p>1.85 4 12 -</p> <p>A 160mm B 120mm C 80mm</p>	<p>54354 34,50€</p> <p>2.91 - 8 270</p> <p>A 160mm B 120mm C 120mm</p>	<p>54483 14,00€</p> <p>0.70 - 40 -</p> <p>A 160mm B 120mm C 35mm</p>	<p>54484 26,00€</p> <p>1.75 - 20 -</p> <p>A 160mm B 120mm C 70mm</p>
<p>54485 36,00€</p> <p>2.40 - 8 -</p> <p>A 160mm B 120mm C 100mm</p>	<p>54355 12,00€</p> <p>0.20 - 60 -</p> <p>RAVAGLIOLI/SIRIO/SPACE A 123mm D 108mm B 26mm E 10mm C 104mm</p>	<p>54360 14,00€</p> <p>0.19 - 72 -</p> <p>RAVAGLIOLI/SIRIO/SPACE A 130mm D 125mm B 23mm E 10mm C 121mm</p>	<p>54486 9,50€</p> <p>0.10 - 120 -</p> <p>RAVAGLIOLI/SIRIO/SPACE A 100mm D 85mm B 22mm E 8,5mm C 81mm</p>
<p>54488 15,00€</p> <p>0.25 - 40 -</p> <p>RAVAGLIOLI A 150mm D 135mm B 25mm E 10mm C 128mm</p>	<p>54493 13,50€</p> <p>0.20 - 60 -</p> <p>RAVAGLIOLI A 120mm B 110mm C 27mm</p>	<p>54494 14,00€</p> <p>0.30 - 48 1152</p> <p>RAVAGLIOLI A 145mm B 135mm C 26mm</p>	<p>54357 15,00€</p> <p>0.29 - 60 -</p> <p>TWIN BUSCH A 120mm D 105mm B 30mm E 8,5mm C 100mm F 66mm</p>
<p>54358 18,50€</p> <p>0.36 - 44 -</p> <p>TWIN BUSCH A 140mm D 125mm B 25mm E 10mm C 116mm F 66mm</p>	<p>54361 14,00€</p> <p>0.25 - 52 -</p> <p>TWIN BUSCH A 140mm D 125mm B 28mm E 8mm C 120mm</p>	<p>54363 14,00€</p> <p>0.30 - 44 -</p> <p>ISTOBAL/VELYEN A 155mm D 147mm B 24mm E 6mm C 140mm</p>	<p>54365 12,50€</p> <p>0.20 - 108 -</p> <p>ISTOBAL/VELYEN A 145mm B 10mm C 60mm</p>

RUBBER LIFT PAD FOR ELEVATOR

54359 14,00€

0.31 - 48 1440

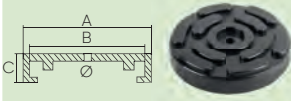

OMCN

A 140mm
B 133mm
C 27mm

54491 17,50€

0.30 - 44 -

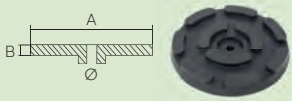

OMCN

A 145mm
B 25mm

54366 18,50€

0.30 - 80 -



NASSBAUM/AMI

A 125mm **D** 120mm
B 24mm
C 90mm

54362 14,00€

0.25 - 48 -

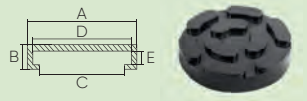

CASCOS

A 138mm **D** 130mm
B 25mm **E** 9mm
C 120mm

54487 15,00€

0.15 - 80 -

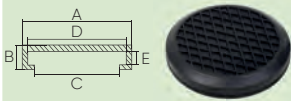

ROTARY

A 123mm **D** 112mm
B 22mm **E** 8mm
C 90,5mm

54495 18,00€

0.25 - 108 3240

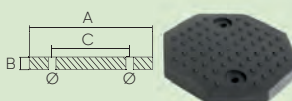

ROTARY

A 125mm
B 15mm
C 90mm

54496 16,50€

0.10 - 400 2400

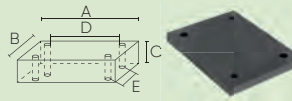

ROTARY

A 104mm **D** 80mm
B 82mm **E** 56mm
C 8mm

54497 12,50€

0.15 - 88 2700

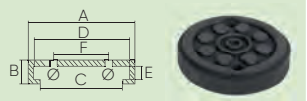

MAHA

A 120mm **D** 113mm
B 22mm **E** 8mm
C 102mm **F** 83mm

54492 19,50€

0.35 - 60 -

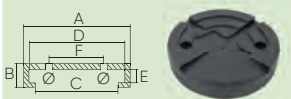

SLIFT/IME

A 125mm **D** 110mm
B 25mm **E** 9mm
C 120mm **F** 83mm

54356 19,50€

0.44 - 48 1152

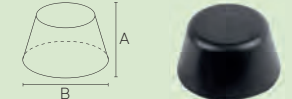

500E/500X/JEEP RENEGADE

A 55mm
B 100mm

54364 14,00€

0.29 - 52 -

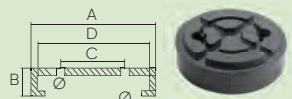

LAUNCH/TWIN BUSCH/RP TOOLS

A 120mm **D** 108mm
B 32mm
C 70mm

54489 19,50€

0.35 - 28 -

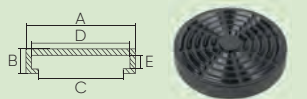

KONI/ROMERICO/CAR-O-LINER

A 160mm **D** 153mm
B 29mm **E** 10mm
C 140mm

54490 15,00€

0.20 - 88 -

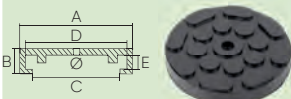

ATH/HOFMANN/
HERMANN/J.A.B. BECKER

A 120mm **D** 110mm
B 19mm **E** 4mm
C 130mm

54175

0.80 5 20 360



SET OF 4 TESLA LIFTING PADS

NR TESLA 3/X/S/Y

34,00€



ELECTRIC TOOLS

- 328 JUMP STARTER
- 329 BATTERY MAINTENANCE
- 330 MILTIMETERS
- 332 VISUAL INSPECTION
- 332 WELDING
- 334 WORKSHOP EQUIPMENT
- 337 AIR CONDITIONING
- 338 THERMOMETERS
- 338 OTHERS



ELECTRIC TOOLS

STARTER CABLES

BRASS SOLID CLAMPS

REF.	Ø CABLE	LENGTH	A	SECTION					€
51238	17mm	5m	700	70mm ²	4.95	-	2	84	138,00€
51239	15mm	7m	700	70mm ²	5.90	-	2	72	159,00€

BRASS CLAMPS

REF.	Ø CABLE	LENGTH	A	SECTION					€
52069	11mm	2,5m	250	25mm ²	1.55	-	10	240	29,50€
52070	12mm	3m	350	35mm ²	1.95	-	5	160	40,00€
52071	13mm	3m	500	50mm ²	2.35	-	5	90	47,00€

BRASS SOLID CLAMPS WITH OVERLOAD PROTECTOR

REF.	Ø CABLE	LENGTH	A	SECTION					€
51363	12mm	3m	350	35mm ²	2.63	-	5	120	114,00€
51365	12mm	3m	600	50mm ²	3.10	-	5	90	118,00€



REF. DESCRIPTION

REF.	DESCRIPTION					€
14145	STARTER CABLE COPPER CLIPS	0.20	-	30	-	8,50€
14146	STARTER CABLE COPPER CLIPS	0.20	-	30	1920	8,00€
14147	SOLID BRASS BOOSTER CLAMPS	0.35	-	15	-	25,00€
14148	SOLID BRASS BOOSTER CLAMPS	0.35	-	15	-	25,00€

53687

298,00€

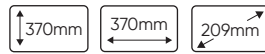
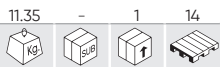

JUMP STARTER 12V

- Voltage: 12V.
- Battery: 222Ah Lead-acid battery (1PCS).
- Starting current: 750A.
- Peak current: 1500A.

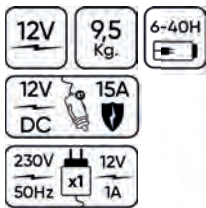

SPARE PARTS AVAILABLE

- A INTERNAL BATTERY VOLTAGE STATUS
- B INTERNAL BATTERY VOLTAGE TEST BUTTON
- C ON/OFF SWITCH
- D BUILT-IN LED LIGHT: INCREASES THE WORKING AREA VISIBILITY

53688

495,00€

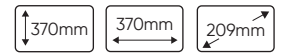
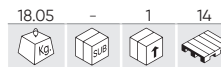

JUMP STARTER 12/24V

- Voltage: 12V/24V.
- Battery: 22Ah Lead-acid battery AGM (2PCS).
- Starting current: 12V: 1500A/3000A.
- Peak current: 24V: 750A/1500A.
- Battery charging time:
Battery completely empty: 8 hours
Battery level at 10-20%: 4 hours

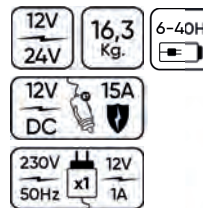

SPARE PARTS AVAILABLE

- A INTERNAL BATTERY VOLTAGE STATUS
- B INTERNAL BATTERY VOLTAGE TEST BUTTON
- C ON/OFF SWITCH
- D BUILT-IN LED LIGHT: INCREASES THE WORKING AREA VISIBILITY

51816 58,00€



DIGITAL BATTERY TESTER

- 150Ah.
- For use with 12V batteries.
- Measurement in SAE (CCA), EN, IEC, DIN, CA.
- Range: 200-1200 CAA (SAE).
- Volt measurement: 7V-15 V.
- Display 4 + 3 LEDs (green, red, yellow).



51235 49,00€



BATTERY TESTER

- For 6V and 12V batteries.
- Charge up to 100 Ah.
- Charge status test.
- Startup consumption test.
- Charge voltage test.
- Battery condition test.



52884 73,00€



MEMORY SAVER FOR CHANGE BATTERY



- Useful to keep current in the electrical system of the vehicle during battery change.
- OBDII connection by cable or cigarette lighter.



53209 8,50€



BATTERY HYDROMETER

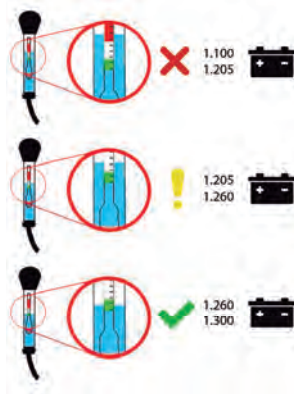

Compatible with ALL ACID batteries: Wet, GEL, MF and AGM

53927 66,00€

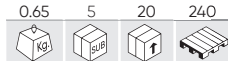

100V 240V	60W	50-60 HZ
72 VDC 0.9-3.6A	0°C 40°C	
6V 7.2V	12V 14.4V	NORM
6V 7.4V	12V 14.7V	COLD/AGM



53929 95,00€

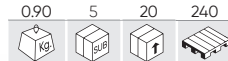

100V 240V	150W	50-60 HZ
14.7 VDC 3.6-7.2A	-20°C 40°C	
12V 14.4V	24V 28.8V	NORM
12V 14.7V	24V 29.4V	COLD/AGM



ELECTRIC TOOLS

52233

328,00€

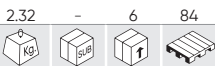

DIGITAL BATTERY TESTER WITH PRINTER

- For use with 6V and 12V batteries.
- Charging and opening systems of 12V and 24V.
- Operational range: 40 - 2000 CCA (SAE).
- Volt measurement: 1.5V - 30V.
- 180 cm cable set.
- Includes: 1 thermal paper roll.



AGM, GEL, VRLA, SLI



54040

240,00€

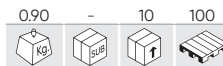

BATTERY TESTER WITH PRINTER

- Applicable to 12V, AGM, GEL, VRLA, SLI batteries.
- Operating Range: 100 - 2000 CCA (SAE)
- Available system languages: ES, EN, FR, DE, IT, PT, RO.
- Applicable to 12/24V starting systems.
- Applicable to 12V, AGM, GEL, VRLA, SLI batteries.
- Starter and alternator tester.
- Includes: CR2032 battery included



REF.	DESCRIPTION	kg	SUB	mm	€
51842	THERMAL PAPER FOR PRINTER REF. 52233-54040	0.10	6	72	6,90€

54256

48,00€



ANTI-ZAP PROTECTOR 12/24V



52231

49,00€

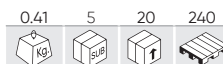

MULTIMETER ACCESSORIES SET

- Suitable for most of the multimeters.

- INCLUDES**
- 2 probes.
 - 2 little clamps.
 - 2 large clamps.
 - extension cables.



54114

248,00€

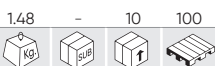

INSULATION TESTER

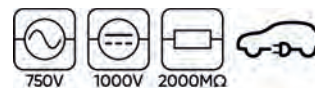

Installation category:	2
Measurement category:	CAT III
Altitude:	Up to 2000 meters
Display:	LCD with dual display
Voltage	AC: 0 - 750V
Voltage DC:	0 - 1000V
Resistance:	0 - 200Ω / 200 - 2000 Ω
Insulation resistance	: 0 - 200MΩ / 200 - 2000 MΩ
Sampling rate:	2.5 times per second
Zero adjustment:	Automatic adjustment
Operating temperature:	00 - 400C (320F - 1040F), relative humidity below 80%

Storage temperature:	-100C - 600C (140F - 1400F), relative humidity below 70%
Power source:	DC9V (6x1.5V Size "AA" batteries)
Dimensions (length x width x high):	200 x 92 x 50mm



50942

28,00€

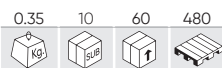

DIGITAL MULTIMETER

- Battery indicator.
- 9 V batteries.
- Temperature gauge.
- Temperature -40 °C to 1000 °C.



AC	AC
200mV, 2V, 20V, 200V, 1000V	20mA, 200mA, 20A
DC	DC
200mV, 2V, 20V, 200V, 750V	20mA, 200mA, 20A
Ω	F
200Ω, 2KΩ, 20KΩ, 200KΩ, 2MΩ, 20MΩ, 2000MΩ	2nF, 20nF, 200nF, 2μF, 20μF, 200μF

52439

227,00€

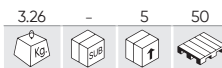

MULTIMETER CABLE SET AND ACCESSORIES

- 2 variable resistance meter.
- 2 test light led.
- 2 SRS substitution and prove dispositives.
- 2 Alligator pliers.
- 2 Latching sockets.
- 4 probe.
- 24 round connectors.
- 48 flat connectors.



52382

19,50€

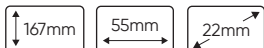
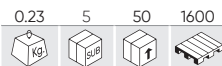

DIGITAL CLAMP METER

- Voltage AC, DC, Current AC test, electric current resistance, diode test, etc.
- Operating: 0°C a 40°C, a <80%RH.
- Storage: -10°C a 40°C, a <85%RH.
- 2 batteries sizes AAA.
- Indicator battery low.
- Screen 3,5" with 4 digit.
- DC function.
- Medidor AC/DC.



DCB 600V
ACB 600V
DCA -
ACA 20A, 200A, 600A
OHM 2KΩ, 200KΩ, 2MΩ

- FUNCTIONS:
Live wire test.

52952

74,00€

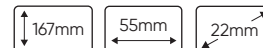
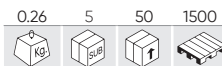

PROFESSIONAL DIGITAL CLAMP MULTIMETER

- Voltage AC, DC, Current AC test, electric current resistance, diode test, etc.
- Operating: 0°C a 40°C, a <80%RH.
- Storage: -10°C a 40°C, a <85%RH.
- 2 batteries sizes AAA.
- Indicator battery low.
- Screen 3,5" with 4 digit.
- DC function.
- Medidor AC/DC.



DCB 20V, 600V
ACB 600V
DCA 200A
ACA 200A
OHM 2000Ω

- FUNCTIONS:
Live wire test.
Diode test.
continuity test.
ADP Function.
Phase detection function.
ZERO Switch.

53028

5,80€

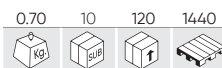

AUTOMOTIVE CIRCUIT TESTER 1,8X190MM

6-12-24V
1,8 x 190mm



- Suitable for polarity testing.

53029

6,80€

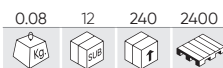

AUTOMOTIVE CIRCUIT TESTER 2X115MM

6-12-24V
2 x 115mm



53030

12,00€



AUTOMOTIVE CIRCUIT TESTER 3X142MM

6-12-24V
3 x 142mm
LED



53724

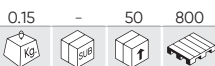

WIFI ENDOSCOPE CAMERA

- Endoscope with Wi-Fi enabled compatible with all kind of smartphones. Able to connect with tablets and computers.

- The equipment includes:
Endoscope.
Wi-Fi connection port.
Hook tip.
Magnetic tip.
Mirror tip for side view.

1M SEMI-RIGID CABLE



WORKS WITH JBM APP:



46,00€

53484

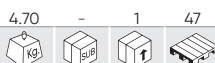

SMOKE LEAK DETECTOR

- OIL NOT INCLUDED.



IT CONTAINS

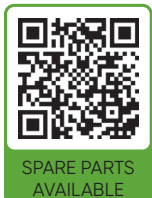

SPARE PARTS AVAILABLE

615,00€



53977



40W SOLDERING IRON

- Voltage 220-240V
- 40W
- Frequency: 50Hz
- Large 240MM
- Cable: 1.3m
- Max. working temperature: 450°+/-10%



17,50€



53111



100W SOLDERING IRON

- Voltage: 220-240V.
- Temp.: 420°C + / - 10%.
- Large: 250mm.
- Cable: 1,5m.



19,00€



53145



HOT AIR GUN 2000W

- 220V-240V.
- 50Hz-60HZ.
- 2000W.
- Output temperature: 50-600°C.
- Airflow: 220-480L / min.
- 2 temperature options: 300 and 600°C.



39,20€

53162



DIGITAL HOT AIR GUN 2000W

- 220V-240V.
- 50Hz-60HZ.
- 2000W.
- Output temperature: 100-600°C.
- Airflow: 280-480L/min.



60,00€

53981

143,00€

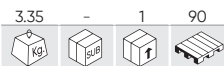

MMA INVERTER WELDER 100A DC

INCLUDES

- Electrode holder with 2m cable
- Earth clamp with 1.5m cable
- Hammer brush
- Hand-held face shield

- ✓ IGBT TECHNOLOGY INVERTER
- ✓ MMA DC
- ✓ ANTI STICK
- ✓ ARC FORCE
- ✓ HOT ARC START



53982

219,00€

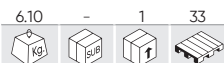

MMA INVERTER WELDER 160A DC

INCLUDES

- Electrode holder with 2m cable
- Earth clamp with 1.5m cable
- Hammer brush
- Hand-held face shield

- ✓ IGBT TECHNOLOGY INVERTER
- ✓ MMA DC
- ✓ ANTI STICK
- ✓ ARC FORCE
- ✓ HOT ARC START



53414

49,00€



WELDING MASK WITH MANUAL REGULATOR



ANALOGIC REGULATOR TO ADJUST SENSITIVITY AND DARKENING

53415

188,00€



WELDING MASK WITH DIGITAL REGULATOR



DIGITAL REGULATOR TO ADJUST SENSITIVITY, DARKENING AND CADENCE

MAGNETIC SQUARE 45°, 90°, 135°

REF.	↔	kg	box	box	box	€
54111	75mm	0.35	10	40	1680	4,75€
54113	100mm	0.60	10	20	1100	7,65€



54482

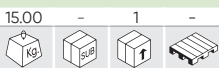

677,00€

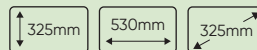

N

ULTRASONIC PARTS CLEANER 30L

This machine allows you to clean parts by emitting ultrasounds. It is especially indicated for cleaning parts with complex shapes.

ULTRASONIC POWER: 600W	POWER SUPPLY: 200~240V (50HZ)
HEATING POWER: 500W	NUMBER OF TRANSDUCTORS: 10
TANK CAPACITY: 30L	HEATER: 0~80°C
ULTRASONIC FREQUENCY: 40KHZ	MATERIAL: STAINLESS STEEL SUS304
TIMER: 1~30 MIN.	TANK DIMENSIONS: 500x300x200mm



53220



260,00€

PORTABLE PARTS WASHER

- PORTABLE FORMAT.
- Allows watertight closing to avoid losses during transport.
- To be used with aqueous-based solvent.
- Side ignition switch.
- Liquid cleaning filter included.
- Tool hose and hose included.
- Storage compartment.
- Separation of work areas, cleaning area and drying area, allowing work with several pieces at a time.
- Max. Cap. 27,5L.
- Pumping capacity: 1,000 L / h.
- Working capacity: 20L.
- Connection to 220V.
- Hose of 1.10m long.



BENCH GRINDERS

REF.	W	V/W	RPM	HZ	Ø I	Ø II	Ø III	Weight	Volume	Quantity	Accessories	€
53656	450W	230V/450W	2950RPM	50Hz	Ø 150mm	Ø 20mm	Ø 12,7mm	11.05	-	1	50	198,00€
53657	600W	230V/600W	2950RPM	50Hz	Ø 200mm	Ø 25mm	Ø 15,88mm	16.35	-	1	24	248,00€
53658	250W	230V/250W	2950RPM	50Hz	Ø 150mm	Ø 20mm	Ø 12,7mm	6.95	-	1	60	99,00€
53659	250W	230V/250W	2950RPM	50Hz	Ø 150mm Ø 200mm	Ø 20mm Ø 40mm	Ø 12,7mm Ø 20mm	9.70	-	1	15	121,00€



53656
53657



53658



53659

52195



170,00€

BRENCH GRINDER 150MM

- Power entrance: 250W.
- Voltage: 230V / 50Hz.
- Velocity without charge: 2.950Rpm.
- Ø round: 150 x 20 x 12.7mm.



53660



146,00€

ADJUSTABLE BENCH GRINDER STAND

- Height: 790mm.
- Mounting plate size: 250x280mm.
- Weight: 8kg.



54342 858,00€ N

49.50 - 1 4

PARTS CLEANER MACHINE WITH THERMOSTAT

70-120 PSI 0,8 L/min
 MAX 50°C 8-14L
 5 CFM 740mm 560mm 452mm

1710mm
 790mm
 610mm



Machine designed for perfect washing of dirty parts. It includes a pneumatic gun to clean with solvent and can also be used to dry the parts using compressed air. Thanks to its closed cabin, the operator is completely protected from splashes and odour of the solvent.

It has a thermostat with which you can adjust the temperature level of the cleaning liquid and light inside the tank for better visualization.

SPARE PARTS AVAILABLE

54341 643,00€ N

51.00 - 1 7

SANDBLASTING MACHINE 220L

100V 40-120 PSI
 240V
 15-25 PSI 33L
 860mm 560mm 560mm

390mm
 905mm
 632mm



This sandblasting machine is easy to operate, portable and offers a safe environment, ready for use with the abrasive media of your choice with the ability to clean following parts: rusted parts, stains etc.

SPARE PARTS AVAILABLE

52980 480,00€ 150L

45.00 - 1 4

150L PARTS WASHER

TOTAL MACHINE MEASUREMENTS 890mm 1.090mm 520mm
INTERIOR MEASURES DEPOSIT 270mm 1.060mm 490mm



SPARE PARTS AVAILABLE

50632 298,00€ 100L

24.20 - 1 6

PIECE CLEANER

TOTAL MACHINE MEASUREMENTS 890mm 780mm 540mm
INTERIOR MEASURES DEPOSIT 260mm 725mm 490mm



SPARE PARTS AVAILABLE

- Volume: 25L.
 - It works with water soluble motor cleaning solutions.

- Volume: 25L.
 - It works with water soluble motor cleaning solutions.

51837

195,00€

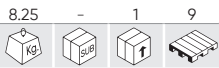

30 LITRE VACUUM CLEANER DRY

30L

Capacity (l)	30
Suction liters per second (l/s)	26
Power	1x1.200W
Voltage	230V
Frequency	50Hz
Suction	> 17Kpa
Ø hose	32mm
Hose length	1,5m
Cable length	4,5m
Sealing	IPx4



SPARE PARTS AVAILABLE

IT CONTAINS



* This vacuum cleaner has a system that allows an automatic switch-on if it is connected to a grinder.

51838

667,00€

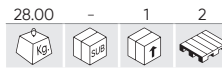

80 LITRE VACUUM CLEANER (DRY AND WET)

80L

Capacity (l)	80
Suction liters per second (l/s)	50
Power	3x1.000W
Voltage	230V
Frequency	50Hz
Suction	> 20Kpa
Ø hose	48mm
Hose length	2m
Cable length	4,5m
Sealing	IPx4



SPARE PARTS AVAILABLE

IT CONTAINS



53947

145,00€

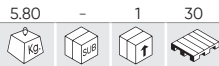

HIGH PRESSURE WASHER 1400W

230V	1400W	MAX 105 Bar	MAX. WATER 50°C	5,0Kg
MAX 6,8L/min	5m	3m	50 Hz	IP X5

IT CONTAINS



SPARE PARTS AVAILABLE

- A SPRAY GUN
- B POWER CABLE
- C WATER OUTPUT
- D PRESSURE HOSE

53948

324,00€

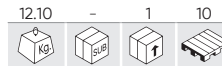

HIGH PRESSURE WASHER 2400W

230V	2400W	MAX 180 Bar	MAX. WATER 50°C	10,0Kg
MAX 8L/min	5m	8m	50 Hz	IP X5

IT CONTAINS



SPARE PARTS AVAILABLE

- A PRESSURE HOSE
- B SPRAY GUN
- C WATER OUTPUT
- D POWER CORD

53189 128,00€

7.10 - 1 12

1325mm 480mm Ø565mm

STAND FAN

230V 50 Hz
120V

X3 SPEED RPM 1050/1150/1300 CFM 2700/3000/3400



54125 152,00€

8.25 - 1 14

1250mm 400mm Ø430mm

MIST FAN

3,2L 75W
220V 50 Hz
240V

0.5-7.5H motor de cobre/ copper engine

mando/remote



SPARE PARTS AVAILABLE



53543 13,80€

0.75 5 20 160

CAR FAN - 12V

12V 15,20cm

X2 SPEED



53190 98,00€

6.10 - 1 16

575mm 230mm Ø620mm

FLOOR FAN

230V 50 Hz
120V

X3 SPEED RPM 1050/1150/1300 CFM 2700/3000/3400



54229 48,00€

1.76 - 4 80

2KW HEATER

2Kw 220V 240V 1000-3000 RPM 20m²

SPCC PTC 197m³/h 210-160 -217mm



54229
54230

54230 68,00€

3.10 - 1 56

3KW HEATER

3Kw 220V 240V 1000-3000 RPM 30m²

SPCC PTC 197m³/h 210-160 -217mm

54231 138,00€

4.80 - 1 27

5KW HEATER

5Kw 380V 400V 1000-3000 RPM 48m²

SPCC PTC 588m³/h 300-235 -345mm

1,4m



54231
54232

54232 248,00€

7.90 - 1 12

9KW HEATER

9Kw 380V 400V 1000-3000 RPM 80m²

SPCC PTC 1180m³/h 395-307 -455mm

1,4m

ELECTRIC TOOLS

52162 **38,00€**

0.17 6 72 576

145mm 90mm 37mm

LASER THERMOMETER -50°C TO 550°C

-50°C ~ 550°C
-58°F ~ 1022°F
±2°C / ±2%



52450 **105,00€**

0.72 5 20 200

175mm 105mm 48mm

LASER INFRARED THERMOMETER -50° TO 1000°C

1000°C
-50°C

-50°C ~ 1000°C
-58°F ~ 1832°F
±1,5°C

Includes included



53503 **12,00€**

0.05 20 100 2400

-50°C ~ 330°C
-58°F ~ 572°F
±1°C (0.2°F)
(-20°C ~ 60°C)

CONTACT DIGITAL THERMOMETER



53585 **168,00€**

8.35 - 2 36

21M RETRACTABLE ELECTRIC CABLE REEL

H07RN-F
3G1.5mm²

230V 1000W 3000W IP 44

21m



53586 **168,00€**

8.35 - 2 30

21M RETRACTABLE ELECTRIC CABLE REEL

H07RN-F
3G1.5mm²

230V 1000W 3000W IP 44

21m



REF.	DESCRIPTION					€
14771	WALL MOUNT FOR HOSE REELS 53532, 53581, 53585, 53586	0.35	-	30	-	10,50€

53584 **119,00€**

5.10 - 4 48

12M RETRACTABLE ELECTRIC CABLE REEL

H07RN-F
3G1.5mm²

230V 1000W 3000W IP 44

12m

Tapa/top



53526 **119,00€**

5.15 - 4 48

12M RETRACTABLE ELECTRIC CABLE REEL

H07RN-F
3G1.5mm²

230V 1000W 3000W IP 44

12m

Tapa/top



REF.	DESCRIPTION					€
14774	WALL MOUNT FOR HOSE REELS 53526, 53584	0.40	-	10	-	10,50€

51831 24,00€

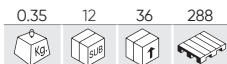

HEAT-MELT ADHESIVE GUN

- Voltage: 100~ 230 V.
- Temperature: 190~230 °C.
- Consumption: 60~150 W.
- Ø nozzle: 2.0~2.3 mm.
- Range: 8 - 16g of product/min.



REF.	DESCRIPTION					€
51859	BLISTER 10U HEAT-FUSION ADHESIVE FOR REF. 51831	0.12	8	32	1520	3,80€

51033 98,00€



ELECTRIC CABLE REEL EXTENSION 25M



- Overload protection.
- Child protection.



EXTENSION CABLE

REF.	m					€
53166	3m	0.45	5	30	600	10,50€
53167	5m	0.65	5	20	600	12,50€
53168	10m	1.20	-	10	300	19,00€



52643 596,00€



TYRE GROOVING MACHINE

DIGITALLY DIMMABLE

REF.	DESCRIPTION				€
11974	REPLACEMENT R1 FOR TYRE BRANDER MACHINE REF. 52643	0.01	20	500	1,80€
11975	REPLACEMENT R2 FOR TYRE BRANDER MACHINE REF. 52643	0.01	20	500	1,80€
11976	SPARE R3 FOR TYRE BRANDER MACHINE REF. 52643	0.01	20	500	1,80€
11977	SPARE R4 FOR TYRE BRANDER MACHINE REF. 52643	0.01	20	500	1,80€
11978	SPARE R5 FOR TYRE BRANDER MACHINE REF. 52643	0.04	20	100	1,80€
11979	REPLACEMENTS W1 FOR TYRE BRANDER MACHINE REF. 52643	0.04	20	500	1,80€
11980	REPLACEMENT W2 FOR TYRE BRANDER MACHINE REF. 52643	0.04	20	500	1,80€
11981	REPLACEMENT W3 FOR TYRE BRANDER MACHINE REF. 52643	0.01	20	500	1,80€
11982	REPLACEMENT W4 FOR TYRE BRANDER MACHINE REF. 52643	0.01	20	200	1,80€
11983	REPLACEMENT W5 FOR TYRE BRANDER MACHINE REF. 52643	0.04	20	500	1,80€



SPARE PARTS

REF.	11974	11975	11976	11977	11978
BLADE TYPE	R1	R2	R3	R4	R5
ROUND BLADE	mm	mm	mm	mm	mm
	A 3	5	6	8	10
	B 7	7	10	12	12
	C 5	8	15	16	18
	D 21	21	23	25	24

REF.	11979	11980	11981	11982	11983
BLADE TYPE	W1	W2	W3	W4	W5
SQUARE BLADE	mm	mm	mm	mm	mm
	A 3	5	7	9	11
	B 7	7	10	12	12
	C 5	6	10	13	15
	D 21	21	22	24	23

52598

1.080,00€

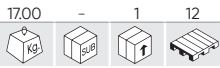

ROBOTIC LAWN MOWER



Modern and functional robotic lawnmower, perfect for the care and maintenance of your lawn and green spaces. It is equipped with a brushless motor, powered by a powerful 5200 Ah battery, for a range of approximately 150 minutes. The cutting deck with three steel blades that will perform a mulching cut. This cutting system shreds the grass very finely, and then drops it directly on the ground, giving the lawn an impeccable appearance without proceeding to remove the remains. In addition, with this cut, the grass deposited on the lawn will decompose and become a nutrient for the soil, creating a completely natural biological cycle. The perimeter wire and stakes supplied allow for easy, tool-free installation.



SPARE PARTS AVAILABLE

- A BRUSHLESS MOTOR
- B STOP BUTTON
- C CHARGING STATION
- D REAR WHEEL
- E KNOB LID

APP CONNECTION



54252

199,00€



MANUAL PUSH SWEEPER

- A DIRT COLLECTION CONTAINER
- B MAIN BODY
- C LEFT DISK BRUSH
- D RIGHT DISC BRUSH
- E TOP CAP
- F UPPER PUSH HANDLE
- G LOWER PUSH HANDLE
- H CARRYING HANDLE

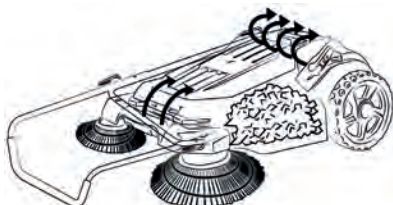
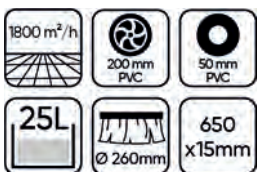

SPARE PARTS AVAILABLE

RENEWABLE ENERGY AND MOBILITY OF THE FUTURE

342 ELECTRIC CAR CHARGING CABLES

342 ELECTRIC CAR CHARGERS

343 POWER GENERATOR

344 INSULATED TOOLS



CHARGING CABLE

TIPO 1-2 TYPE 1-2

REF.	DESCRIPTION					€
54053	ELECTRIC CAR CHARGING CABLE, 3.6KW, 16 A, TYPE 1 TO TYPE 2 (SINGLE-PHASE)	2.15	-	5	-	248,00€
54054	ELECTRIC CAR CHARGING CABLE, 7.5KW, 32 A, TYPE 1 TO TYPE 2 (SINGLE-PHASE)	2.90	-	5	100	268,00€

-25°
+55°

Tipo
1-2

IP66

5m



TIPO 2-2 TYPE 2-2

REF.	DESCRIPTION					€
54055	ELECTRIC CAR CHARGING CABLE, 3.6KW, 16 A, TYPE 2 TO TYPE 2 (SINGLE-PHASE)	2.15	-	5	100	220,00€
54056	CHARGING CABLE FOR ELECTRIC CAR, 11KW, 16 A, TYPE 2 TO TYPE 2 (THREE-PHASE)	2.85	-	5	102	260,00€
54057	ELECTRIC CAR CHARGING CABLE, 7.5KW, 32 A, TYPE 2 TO TYPE 2 (SINGLE-PHASE)	2.95	-	5	102	248,00€
54058	ELECTRIC CAR CHARGING CABLE, 22KW, 32 A, TYPE 2 TO TYPE 2 (THREE-PHASE)	3.85	-	5	100	348,00€

-25°
+55°

Tipo
2-2

IP66

5m



WALL CHARGER

REF.	DESCRIPTION					€
52600	WALL CHARGER 3.6 KW, 16 A, FOR ELECTRIC CARS (SINGLE-PHASE)	4.65	-	4	80	884,00€
52902	WALL CHARGER 7.5 KW, 32 A, FOR ELECTRIC CARS (SINGLE-PHASE)	4.90	-	4	40	970,00€
52903	WALL CHARGER 11 KW, 16 A, FOR ELECTRIC CAR (THREE-PHASE)	5.25	-	1	40	1.100,00€

↑ 295mm

← 195mm

↙ 65mm

IP66

-25°
+55°

Tipo
2



54265

1.290,00€

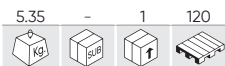

WALL CHARGER 22 KW, 32 A, FOR ELECTRIC CAR (THREE-PHASE)



Trifásico
Three-Phase



Join the future, with our fast charging system for your electric car. Modern and minimalist design. Today with JBM's wall charger you can transform your garage, patio or office parking lot into a user-friendly place for your EV / PHEV.

REF.	DESCRIPTION	kg	m³	Units	€
16130	METER FOR CHARGER 54265	0.40	-	15	290,00€
16198	RFID CARD - 54265	0.01	-	-	5,00€

54059

428,00€



PORTABLE CHARGING STATION 16 A, WITH CHARGING CABLE TYPE 2



With this mobile charger, charge your vehicle wherever you are, with a normal power outlet, no more scares on the road. Also a fast and economical solution to charge electric cars in your workshop. LCD display with access to the most important parameters, integrated type 2 cable, compact design, extremely durable housing and 5 m total cable length is a guarantee of comfort of use and reliability.

REF.	DESCRIPTION	kg	m³	Units	€
15460	RFID CARD	0.01	-	250	5,00€

53970

3.790,00€

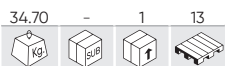

PORTABLE POWER STATION 1920WH/48V 40AH

MPPT	CC-CA	2W(x2) LED	200VAC ±10%	Carga rápida Fast Charging 54V/10A 3-4H	Carga solar Solar Charging 54V/7.5A 4-5H
50-60 Hz	UNIVERSAL	12V 10A			
3000W Salida nominal de CA Rated AC output		1920Wh LiFePO4			
5000W Pico de salida de CA Peak AC output		x2000 Ciclos de carga Battery life cycles			
USB-QC 5V 9V/12V/3A	DC(x2) 12V/10A	Temperatura de descarga Discharging Temperature -10°C/60°C	Temperatura de carga Charging Temperature 0°C/45°C		
USB-Type-C 5V/3A - 9V/2A 12V/1.5A	USB 5V 2.4A*2				

The portable power station is a large-capacity portable electric generator that is recharged by solar power. But it can also be recharged from any power outlet, in the absence of sunlight.

IT CONTAINS

- BATTERY CHARGER
- CHARGER SOLAR PANEL
- CABLE CONNECTOR

COMPATIBLE WITH
54321



54321

898,00€



SOLAR PANEL 200W FOR REF.53970



REF.	DESCRIPTION	kg	m³	Units	€
15448	SET OF 2 MC4 1000V 30A CONNECTORS	0.01	-	186	5,50€

53940

13,20€



YELLOW/BLACK PLASTIC POST

- Material: PVC.
- Refillable base.

CHAIN NOT INCLUDED.



HIGH VOLTAGE AREAS SIGNALING



54326

7,30€



N

PLASTIC CHAIN - YELLOW/BLACK

7m



53987

9,50€

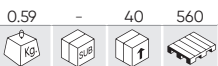

YELLOW / BLACK BARRIER TAPE - 200M

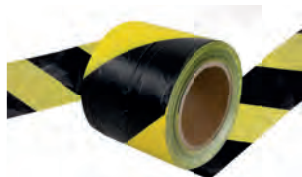

53942

0,50€

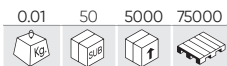

PLASTIC S-HOOK



54322

19,00€

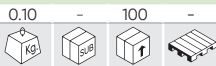

N

SET OF 2 HIGH VOLTAGE WARNING SIGNS



52382

19,50€

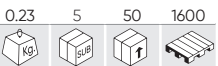

DIGITAL CLAMP METER

DCB	600V
ACB	600V
DCA	-
ACA	20A, 200A, 600A
OHM	2KΩ, 200KΩ, 2MΩ



52952

74,00€



DIGITAL CLAMP METER

DCB	20V, 600V
ACB	600V
DCA	200A
ACA	200A
OHM	2000Ω



50942

28,00€

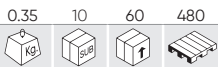

DIGITAL MULTIMETER

- Battery indicator.
- 9 V batteries.
- Temperature gauge.
- Temperature -40 °C to 1000 °C.



54091

441,00€



26 PIECES INSULATED TOOL SET

26PCS
3/8"
CrV
VDE
GS: Geprüfte Sicherheit
1000V
IEC 60900C



54093

441,00€



26 PIECES INSULATED TOOL SET IN EVA TRAY

26PCS
3/8"
CrV
VDE
GS: Geprüfte Sicherheit
1000V
IEC 60900C



53154

462,00€

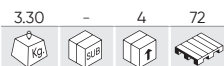

20 PIECES INSULATED TOOL SET 3/8"

20PCS
3/8"
CrV
VDE
GS: Geprüfte Sicherheit
1000V
IEC 60900C



15162

30,20€

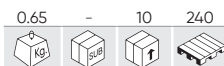

8 PIECES INSULATED SCREWDRIVER SET EVA TRAY CARBON FIBER FINISH

8PCS
VDE
GS: Geprüfte Sicherheit
1000V
IEC 60900C

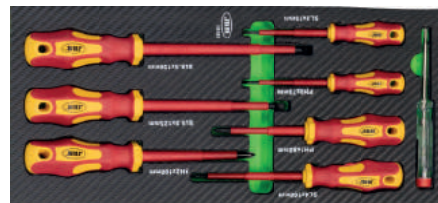

52519

25,50€

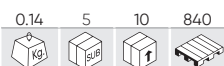

7 PIECES INSULATED SCREWDRIVERS UP TO 1.000V SET

7PCS
CrV
VDE
GS: Geprüfte Sicherheit
1000V
IEC 60900:2004

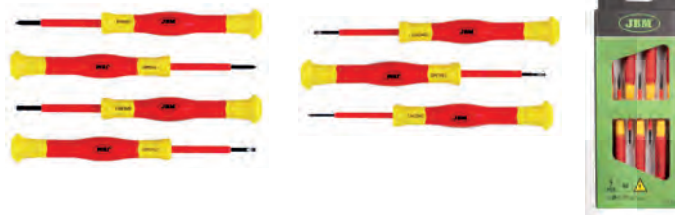

INSULATING GLOVES FOR VOLTAGE WORK

REF.	DESCRIPTION	KG	SUB	QTY	€
54130	T.9	0.35	-	1	58,00€
54131	T.10	0.40	-	1	58,00€

AZC
LATEX
CAT III
CLASS 0
1000V AC / 1500V DC
IEC ELECTRICAL SAFETY
GLOVES 60903-2014 CLASS 0



INSULATED KNIFE

REF.	DESCRIPTION	KG	SUB	QTY	€
53164	STRAIGHT	0.10	6	36	16,50€
53165	HOOK	0.10	6	36	19,60€

CrV
VDE
GS: Geprüfte Sicherheit
1000V
IEC 60900C



TOOL TROLLEY WITH 7 DRAWERS

54236 1.856,00€

67.70 - 1 4

54233 1.856,00€

67.70 - 1 4

54234 1.856,00€

67.70 - 1 4

54235 1.856,00€

67.70 - 1 4



IT CONTAINS

	REF.	UNI.	€		REF.	UNI.	€		REF.	UNI.	€
A	52162	1	38,00€	E	54093	1	441,00€	I	54132	1	190,00€
B	53940	4	13,20€	F	54114	1	248,00€	J	54241	1	120,00€
C	54326	1	7,30€	G	54129	1	110,00€				
D	53942	8	0,50€	H	54130	1	58,00€				

54386

418.00 - 1 1

ENERGY VEHICLE BATTERY ASSEMBLING LIFT

Loading characteristics	Distributed load
Lifting time (without load)	60"
Lowering time (without load)	45"
Platform	1290 - 1400x768mm



1840mm 770mm 650mm

5.839,00€

1,2T
MAX: 1840mm
MIN: 650mm

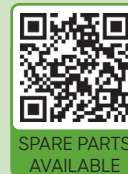

54241

1.10 - 1 50

INSULATED RESCUE HOOK - 45KV



120,00€

∅28mm 1650mm 370mm

54129

2.10 - 5 200

INSULATING MAT CLASS 0

- CLASS 0
- ENROLLABLE ROLLS
- SLIP RESISTANT
- OIL RESISTANT
- RECYCLABLE
- 1000V AC / 1500V DC
- IEC ELECTRICAL SAFETY
- MATting 60903-2024 CLASS 0

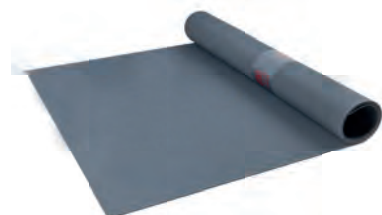

110,00€

1000mm 600mm 2mm

54132

0.70 - 1 72

ELECTRICAL INSULATING FACE SHIELD FOR VOLTAGE WORK

- ANTI-RALLADURAS / SCRACHING PROOF
- ANTI-VAHO / ANTI FOG
- EN 170:2022
- EN 166:2001
- ANSI Z87.1
- CLASS 1



54114

1.48 - 10 100

INSULATION TESTER

- 2000MΩ
- 1000V
- 750V
- CAT III



WORKSHOP ACCESSORIES

348 HOSE REELS

349 LADDERS

350 TROLLEYS AND PLATFORMS



AIR HOSE REEL WITH RETRACTABLE

REF.	m					€
53582	22m 10.85	-	1	14		174,00€
53583	22m 10.75	-	1	14		174,00€
53532	13m 6.60	-	2	30		119,00€
53581	13m 6.70	-	2	30		119,00€
53881	11m 4.50	-	4	48		79,00€
53882	11m 4.50	-	4	48		79,00€

300 PSI
20 BAR

3/8"

Ø 9.5mm



AUTO GUIDE REWIND SYSTEM

WATER HOSE REEL

REF.	m					€
53872	16,5m 7.50	-	1	21		118,00€

15m + 1,5m

120 PSI
8 BAR

3/4"

Ø 15.8mm
Ø 11.5mm

PVC



RETRACTABLE ELECTRIC CABLE REEL

REF.	m					€
53586	21m 8.35	-	2	30		168,00€
53585	21m 8.35	-	2	36		168,00€
53584	12m 5.10	-	4	48		119,00€
53526	12m 5.15	-	4	48		119,00€

230V

1000W
3000W

IP44

H07RN-F
3G1.5mm²



AUTO GUIDE REWIND SYSTEM

15M 1/2" RETRACTABLE OIL HOSE REEL

REF.	m					€
50797	16m	26.60	-	1	14	490,00€

- Oil hose spool
- Hose length: 15+1 m
- Max working pressure: 2450 PSI
- Inlet: 1/2" BSPT
- Outlet 1/2" BSPT
- Material: Steel



160
BAR



TELESCOPIC LADDER

REF.	DESCRIPTION					€
51982	TELESCOPIC LADDER 6 STEPS 2M	5.51	-	1	34	120,00€
51983	TELESCOPIC LADDER 10 STEPS 3.2M	9.41	-	1	34	185,00€
51984	TELESCOPIC LADDER WITH 12 STEPS 3,8M	9.78	-	1	22	190,00€

CERTIFICATION: EN 131

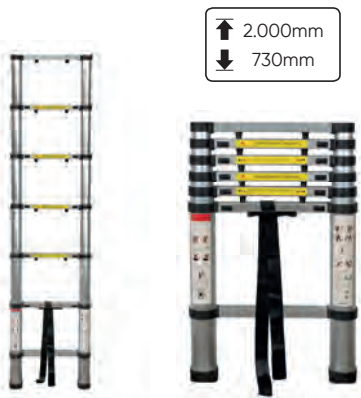

↑ 2.000mm
↓ 730mm

51982

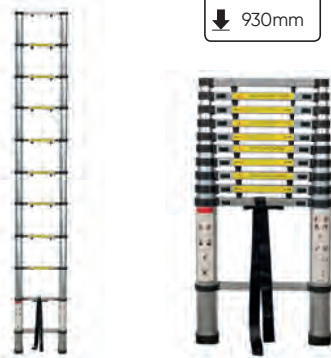

↑ 3.200mm
↓ 930mm

51983



↑ 3.800mm
↓ 1.020mm

51984

52149

14.00	-	1	14

230,00€

MULTI-FUNCTIONAL TELESCOPIC LADDER

- Multi-functional and light ladder.
- Block system.
- Made of aluminium and plastic.
- Height retracted: 835 mm.
- Height extended: 3800mm.
- Total height: 1900mm.

CERTIFICATION: EN 131



54176

188,00€

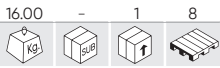

CERTIFICATION: EN 131

MULTI-PURPOSE LADDER

- Maximum length: 3.7m
- Capacity: 150kg
- Material: Aluminum
- Aluminum thickness: 1,2mm
- Space between two rungs: 28cm



CONTAINS

REF. DESCRIPTION

15866	SET OF 2 PLATAFORMS FOR REF.54176	5.00	-	1	-	32,00€
-------	-----------------------------------	------	---	---	---	--------

50517

129,00€

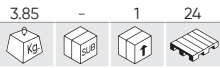

4 STEP ALUMINIUM LADDER

- 4 STEP
- Total height: 1.30 m.
 - Max. working height: 0.79 m.



50518

169,00€

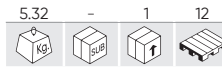

6 STEP ALUMINIUM LADDER

- 6 STEP
- Total height: 1.91 m.
 - Max. working height: 1.31 m.



52230

398,00€

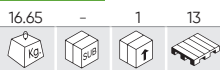

CERTIFICATION: EN 131

STEP ALUMINIUM WORKING PLATFORM

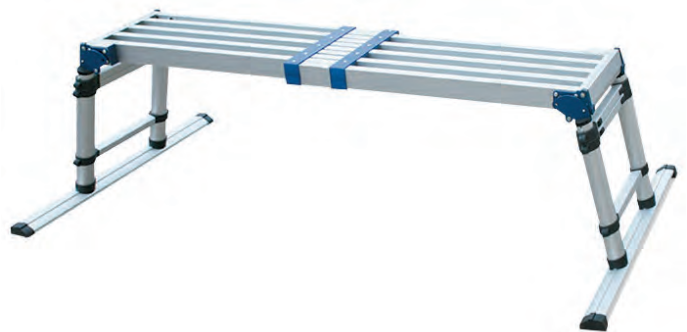

MIN			MAX		
520mm	1090mm	300mm	900mm	1750mm	300mm

REF. DESCRIPTION

10964	CORNER RUBBER SPARE PARTS FOR REF. 52230	0.01	-	1	-	9,00€
10965	LADDER SPARE PART FOR REF. 52230	0.01	-	1	-	6,00€
10966	RUBBER STOPPED SPARE PARTS FOR REF. 52230	0.06	-	1	-	13,50€

50656

290,00€

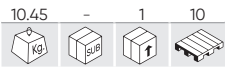

CERTIFICATION: EN 131

2 PIECES STEP ALUMINIUM WORKING PLATFORM SET



REF.	cm					€
11897	100x30x30cm	4.66	-	1	16	155,00€
15552	130x30x55cm	6.80	-	1	18	181,00€

50913

195,00€



CERTIFICATION: EN 131

LARGE STEP ALUMINIUM WORKING PLATFORM



800mm

1400mm

300mm



52202

88,00€

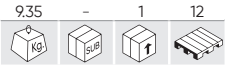

STEEL HAND TROLLEY CAP. 200KG



1100mm

450mm

500mm



REF.	DESCRIPTION					€
12055	WHEEL	1.11	10	160	20,00€	

50924

342,00€

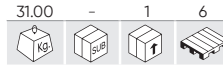

STEEL DRUM HOLDER CART

200L



52200

88,00€

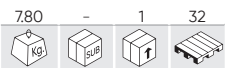

STEEL PLATFORM TROLLEY CAP. 130KG



EXTENDED FOLDED

840mm

230mm

725mm

390mm

475mm

475mm



54305

232,50€



N

FOLDABLE PLATFORM 300KG TROLLEY

EXTENDED

FOLDED

895mm

330mm

610mm

610mm

900mm

900mm



54308

89,00€

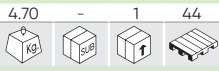

N

FOLDABLE ALUMINIUM TROLLEY 90KG



EXTENDED

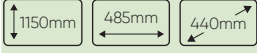

FOLDED

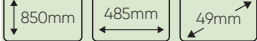

54310

57,00€

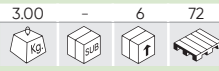

N

FOLDABLE ALUMINIUM TROLLEY 75KG



EXTENDED

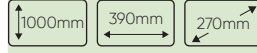

FOLDED

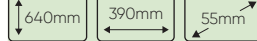

54306

219,50€

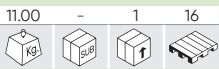

N

FOLDABLE ALUMINIUM TROLLEY 250KG



EXTENDED



FOLDED



54309

71,00€

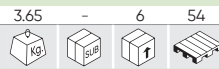

N

STAIR CLIMBING TROLLEY



EXTENDED

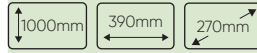

FOLDED

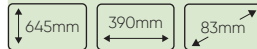

VEHICLE ACCESSORIES

- 354 SIGNALLING
- 355 EMERGENCY KITS
- 357 BULBS
- 358 FIRST AID KITS
- 359 SAFETY
- 359 JOINT BOOT SETS AND CLAMPS
- 361 MATS
- 362 WIPERS
- 363 BIKE
- 364 OTHER
- 366 PARKING SENSORS
- 366 FLEXIBLE TUBES



VEHICLE ACCESORIES

53778

4,50€

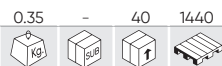

VEHICLE WARNING TRIANGLE APPROVED 27R032736



CONFORMS TO: E4 27R-032736

52795

5,80€



VEHICLE WARNING TRIANGLE APPROVED 27R032738



CONFORMS TO: E4 27R-032738

54298

7,50€



SET OF 2 WARNING TRIANGLE HOM. 27R032736



CONFORMS TO: E4 27R-032736

N

HIGH VISIBILITY REFLECTIVE VEST

CONFORMS TO: EN ISO20471:2013

+A1:2016

51817

4,50€

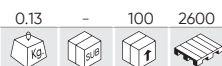

Marked band

50654

4,00€



50966

4,00€

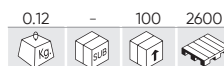

50966C

3,00€



N

TRUCK REFLECTIVE TAPE

REF.	Color	Weight (kg)	Volume (SUB)	Height (mm)	Price (€)
51935	Red	1.04	10	280	135,00€
51936	White	1.04	10	140	135,00€
51937	Yellow	1.02	10	280	135,00€

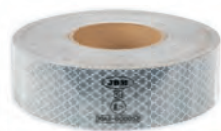

Approval: UNECE 104R REGULATION

- Application as of 10 July 2011 according to modification of General Vehicle Regulation approved by Royal Decree 2822/1998 of 23 December 2010.
- Indivisible 50m spools.

V-20 PLATE "OVERSIZED CARGO"

REF.	Description	Weight (kg)	Volume (SUB)	Height (mm)	Price (€)
53636	MADE OF POLYPROPYLENE FOR GREATER FLEXIBILITY	0.87	25	700	22,00€
53507	FRONT PART MADE OF POLYMETHYLMETHACRYLATE (PMMA) AND BACK PART MADE OF ALUMINUM	0.75	25	800	27,00€



EMERGENCY AND SAFETY KIT

EMERGENCY KIT BAG WITH BORDER

REF.						€
51692	550x90x130mm	0.11	-	100	1600	3,55€
51693	550x90x130mm	0.12	-	100	1200	3,55€
51694	550x90x130mm	0.14	-	100	1200	3,55€
51696	550x90x130mm	0.12	-	80	1200	3,55€



BLACK EMERGENCY KIT BAG

REF.						€
11328	557x110x70mm	0.12	-	100	1200	4,00€



53721 18,80€

0.16	20	80	1440

LED EMERGENCY BEACON

x24 LED 12W 24H	x9 LED 1.8W 5H
-----------------------	----------------------

V16		360°
-----	--	------



IN 20 UNITS
DISPLAY CASE



EMERGENCY KIT PVC BAG

REF.							€
53185	x1	0.69	-	10	200		13,20€
53186	x2	1.04	-	10	200		13,20€

* Double warning triangle, mandatory only in Spain.

CONSULT PRICE BY AMOUNTS
PHOTOLITH AND SERIGRAPHY NOT INCLUDED

EMERGENCY KIT BAG

REF.						€
53621	550x150mm	0.05	-	100	3200	2,50€
53622	550x150mm	0.05	-	100	3200	2,50€
53623	550x150mm	0.05	-	100	3200	2,50€
53624	550x150mm	0.05	-	100	3200	2,50€



BLACK NYLON BAG

REF.						€
15619	330x100x80mm	0.09	-	100	1500	4,00€



N

EMERGENCY KIT

REF.						€
54534	330x100x80mm	0.37	-	10	200	24,00€



PUT YOUR LOGO

N



PUT YOUR LOGO



EMERGENCY KIT

REF.		△		📦	📦	📦	📦	€
52768	■	x2	MK H1	1.81	-	10	200	13,80€
52772	■	x2	MK H1	1.88	-	10	200	13,90€
52776	■	x2	MK H1	1.81	-	10	200	13,80€
52780	■	x2	MK H1	1.94	-	10	200	13,90€
52769	■	x2	MK H4	1.01	-	10	200	14,50€
52773	■	x2	MK H4	1.01	-	10	200	14,60€
52777	■	x2	MK H4	1.07	-	10	200	15,50€
52781	■	x2	MK H4	1.14	-	10	200	14,60€
52770	■	x2	MK H7	2.55	-	10	200	23,00€
52774	■	x2	MK H7	0.99	-	10	200	14,80€
52778	■	x2	MK H7	0.99	-	10	200	14,60€
52782	■	x2	MK H7	1.11	-	10	200	14,80€
52771	■	x2	MK H7+H1	2.75	-	10	200	23,40€
52775	■	x2	MK H7+H1	1.01	-	10	200	15,20€
52779	■	x2	MK H7+H1	1.13	-	10	200	17,10€
52783	■	x2	MK H7+H1	1.01	-	10	200	15,20€



H1 (12V)
H4 (12V)
H7 (12V)

* Double warning triangle, mandatory only in Spain.

EMERGENCY KIT BAG WITH BORDER

REF.		△	📦	📦	📦	📦	€
53177	■	x1	0.63	-	10	200	11,90€
53178	■	x1	0.64	-	10	200	12,20€
53179	■	x1	0.65	-	10	200	12,20€
53180	■	x1	0.63	-	10	200	12,20€
53181	■	x2	0.98	-	10	200	11,90€
53182	■	x2	0.99	-	10	200	12,20€
53183	■	x2	0.99	-	10	200	12,70€
53184	■	x2	0.98	-	10	200	12,20€



* Double warning triangle, mandatory only in Spain.

EMERGENCY KIT BAG WITH BORDER

REF.		△	📦	📦	📦	📦	€
53087	■	x1	0.58	-	10	200	11,20€
53088	■	x1	0.59	-	10	200	11,50€
53089	■	x1	0.61	-	10	200	11,50€
53090	■	x1	0.59	-	10	200	11,50€



EMERGENCY KIT BAG

REF.		△	📦	📦	📦	📦	€
53091	■	x1	0.52	-	10	200	10,20€
53092	■	x1	0.52	-	10	200	10,20€
53093	■	x1	0.52	-	10	200	10,20€
53094	■	x1	0.52	-	10	200	10,20€



REPLACEMENT BULBS AND FUSES SET

REF.							€
51613	12V H1 0.90 10 100 1500						2,90€
51615	12V H9 0.09 10 100 1500						5,95€
51612	12V H11 0.09 10 100 1500						5,95€
50523	12V HB3 0.09 10 100 1500						4,70€
50524	12V HB4 0.09 10 100 1500						4,70€
50915	12V H7+H1 0.10 10 100 1800						4,20€
51614	12V H4 0.10 10 100 1800						3,60€
50431	12V H7 0.08 10 100 1800						3,80€
52047	24V H4 0.09 10 100 1500						3,30€
52048	24V H7 0.10 10 100 1500						3,95€



50551 **350,00€**

CAR BULB CABINET

- 1 POLE STOP
 - P21W 21W BA15S 30 UNITS
 - P21WA 21W BA15S AMBER 10 U.
 - PY21W 21W BAU15S
 - AMBO DESC. 10 UNITS
- 2 POLE STOP
 - R21/5W 21/5W BAY15D 40 UNITS
 - INTERIOR LIGHT
 - C5W 5W SV8.5 11 X 38 22 UNITS
- PILOT LAMPS
 - R5W 5W BA15S 30 UNITS
 - R10W 10W BA15S 30 UNITS
- INDICATOR LAMPS
 - T4W 4W BA9S 22 UNITS
- HALOGEN LAMPS
 - H1 55W P14.5S 10 UNITS
 - H2 55W X511 4 UNITS
 - H3 55W PK22S 4 UNITS
 - H4 60/55W P43T 10 UNITS
 - H7 55W PX26D 10 UNITS
 - HB3 65W P20D 4 UNITS
 - HB4 55W P20D 4 UNITS
 - H9 65W PGJ19-5 4 UNITS
 - H11 65W PGJ19-2 4 UNITS
- EUROPEAN LAMP
 - T5 1.2W W2.1 X 4.6D 20 UNITS
 - T10 5W W2.1X9,6D 12 UNITS
 - T10 3W W2.1X9,6D 12 UNITS
 - T13 10W W2.1X9,6D 10 UNITS
 - T15 18W W2.1X9,6D 10 UNITS
 - T20 21W W5X16D 10 UNITS
 - T20A 21W W5X16D AMBER 10 U.
 - T20 21/5W W5X16D 10 UNITS



OBN BULBS

REF.	DESCRIPTION						€
52365	LAMP OBN H7 12V 55W	0.02	10	200	9000		2,46€
52364	LAMP OBN H1 12V 55W	0.02	10	200	4400		2,86€
52362	LAMP OBN H1 12V 55W	0.01	10	200	14400		1,23€
10766	SPARE LAMP FOR 51960, 51962	0.01	-	200	-		1,59€
52363	LAMP OBN H3 12V 55W	0.02	10	200	14400		1,23€
53203	OBN AMBER LAMP 12V 21W BA15S	0.01	10	200	-		0,46€
52369	LAMP OBN 2 POLES 12V 21/5W T20	0.01	10	1000	18000		1,19€
52368	LAMP OBN 12V 21W T20A	0.01	10	1000	18000		1,14€
53007	OBN R5W 12W 5V LAMP	0.05	10	200	1500		0,42€
52862	OBN WEDGE LAMP 21W 12V T20	0.01	10	1000	1500		1,15€
52370	LAMP OBN ÁMBAR 12V 21W T20	0.01	10	1000	18000		1,17€
52864	OBN WEDGE LAMP 21/5W 12V T20	0.01	10	500	1500		1,20€
52865	OBN WEDGE 10W 12V T13 LAMP	0.01	10	2000	-		0,50€
52866	OBN WEDGE 18W 12V T15 LAMP	0.01	10	2000	256000		0,25€



54042

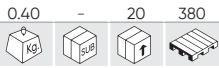

FIRST AID KIT DIN13164:2022

- x1 Adhesive tape DIN13019-A 5x2.5
- x4 Adhesive bandages DIN 13019-E 10x6
- x2 Finger plaster-elastic 4cmx7cm
- x2 Finger plaster-elastic 12cmx2cm
- x2 Plaster strips water resistant 1.9x7.2cm
- x4 Plaster strips water resistant 2.5x7.2cm
- x1 Sterile bandage DIN 13151-K 6x8cm
- x2 Sterile bandages DIN 13151-M 8x10cm
- x1 Sterile bandage DIN 13151-G 10x12cm
- x1 First aid dressings bandage DIN 13152-BR 60x40cm
- x1 First aid dressings bandage DIN 13152-A 60x80cm
- x2 Sterile bandages DIN 61634FB6 6cmx400cm
- x3 Sterile bandages DIN 61634FB8 8cmx400cm
- x1 First aid blanket 160x210cm



13,00€

44 PCS

- x6 Sterile wound compress 10x10cm
- x2 Triangular bandages DIN 13168-D
- x1 Scissor DIN 58279-A145 145cm
- x4 Disposable gloves DIN EN 455-1
- x2 Wet wipe for cleaning skin
- x1 Content list
- x1 First aid manual

51246

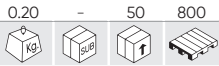

FIRST AID KIT

- x1 First aid pamphlet
- x1 Scissors
- x1 Pair of gloves
- x2 Alcohol towels
- x2 Strips
- x1 25gr. of cotton
- x1 Envelope with 5 gauzes
- x1 Bandage
- x1 Plaster roll



6,40€

11 PCS

54072

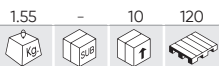

FIRST AID KIT DIN13157

- x1 Adhesive plaster tape 5x25 - DIN13019-A
- x1 Set of adhesive tape bandages 10x6cm (8 pieces) - DIN13019-E
- x6 Finger plaster 4cmx6.5cm
- x6 Finger plaster 120X20mm
- x6 Finger plaster 7.2cmx1.9cm
- x12 Finger plaster 25x72 mm
- x1 First aid dressings bandages, Sterile Compress 6x8cm - DIN13151-K
- x3 First aid dressings bandages, Sterile Compress 8x10cm - DIN13151-M
- x1 First aid dressings bandages, Sterile Compress 10x12cm - DIN13151-G
- x1 Sterile Compress (burn dressings) 60x80cm - DIN13152-A
- x3 Sterile wound dressings (compress) 100mm x100mm 2pcs/bag - DIN58953-2
- x2 Eye pad - 55mmx75mm 1.5g
- x1 Instant Cold compress min.200cm2
- x1 First aid blanket 160cmx210cm 12 microns
- x2 Elastic bandages in compliance with the standard 6cmx400cm - DIN61634 FB6
- x2 Elastic bandages in compliance with the standard 8cmx400cm - DIN61634 FB8
- x2 Triangular bandages 96x96x136cm DIN13168-D
- x1 Metal Scissor 190mm - DIN58279-B190
- x2 Plastic garbage bag 300x400mm 45 microns
- x5 Non-woven Fleece 20cmX30cm min.15g/m2
- x1 Disposable gloves PVC L-AQL1.5 (set of 4 pcs) - DIN EN 455-1



38,50€

67 PCS

- x1 Information brochure
- x2 Face masks, minimum type I, according to DIN EN 14683
- x4 Cleansing wipes for uninjured skin

50644 11,60€

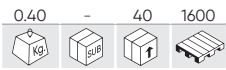

COACH SAFETY 2 POINT BELT

1250mm



CONFORMS TO: E4-16R-0436213

50717 21,90€

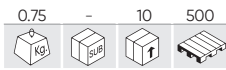

COACH SAFETY BELT 2 POINT ROLLABLE

1330mm



CONFORMS TO: E4-16R-0436232

51266 28,00€

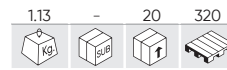

COACH SAFETY BELT 3 POINT ROLLABLE

2900mm



CONFORMS TO: E4-16R-0436232

52259 3,75€

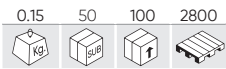

CAR WINDOW BREAKER WITH SUPPORT AND SEATBELT CUTTER

135mm
20mm
75mm
∅ 160mm



51861 199,00€

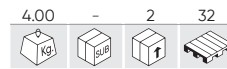

PNEUMATIC CV JOINT EXPANDER

125 PSI
9 BAR

- Material: Aluminum.
- Aperture 20 to 100mm.



CV BOOT EAR CLAMP

REF.	DESCRIPTION					€
11890	CV BOOT EAR CLAMP 50-125MM	0.01	100	1000	18000	0,55€
11891	CV BOOT EAR CLAMP 15-45MM	0.01	100	5000	90000	0,50€
52633	2 PIECE CV BOOT EAR CLAMP SET	0.02	100	800	14400	1,00€



CV JOINT BOOT SET

REF.	DESCRIPTION				€
51703	JOINT BOOT SET FOR VAN	0.28	20	320	10,50€
51705	JOINT BOOT SET FOR CAR	0.23	20	400	8,45€



VEHICLE ACCESORIES

52644

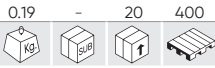

UNIVERSAL STEERING RACK BOOT SET



8,80€

53693

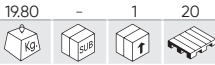

100 PIECE UNIVERSAL STRETCH BOOT SET

521,00€



x100 **52633**

x100 **13738**

x100 **13879**

53698

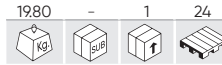

100 PIECE UNIVERSAL STRETCH BOOT SET FOR VAN

717,00€



x100 **52633**

x100 **13739**

x100 **13880**

53695

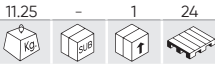

80 PIECE UNIVERSAL STEERING RACK BOOT SET

504,00€



x80 **52633**

x80 **13740**

x80 **13880**

SERIE124

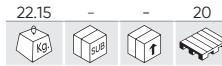

SPECIAL REPLACEMENT CV JOINT BOOT KIT

710,00€



x1 **51861**

x100 **52633**

x100 **13738**

x100 **13879**

SPARE PARTS

REF.	DESCRIPTION					€
13738	PASSENGER CAR CV JOINT BOOT	0.08	-	150	1800	3,50€
13739	VAN CV JOINT BOOT	0.15	-	100	1600	5,50€
13740	PASSENGER CAR RIRECTION BOOT	0.10	-	72	-	5,50€
13879	CV JOINT GREASE	0.09	-	150	5250	1,38€
13880	BELLOWS STEERING GREASE BAG	0.01	-	600	21000	1,50€

360

VAT not included



www.jbmcamp.com

50585

14,70€



UNIVERSAL REVERSIBLE RUBBER CARPET

- High quality rubber.
- Highly resistant.
- Adaptable to most vehicles.

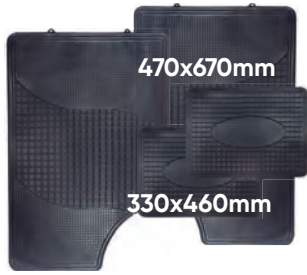

REVERSIBLE!



53241

9,00€



UNIVERSAL RUBBER MAT

- High quality rubber.
- Highly resistant.
- Adaptable to most vehicles.



52534

15,00€



UNIVERSAL CAR MAT WITH COVER PLASTIC



- 2 Front (425x660mm).
- 2 Back (295x425mm).
- Comfortable.
- Reversible with rubber.



52535

16,50€



UNIVERSAL CAR MAT + ALL MAT



- 2 Front (425x660mm).
- 2 Back (295x425mm).
- Comfortable.
- Reversible with rubber.



52530

14,00€

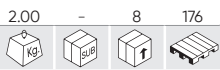

SET UNIVERSAL CAR MAT

- 2 Front (390mm).
- 2 Back (365x480mm).
- Comfortable.
- Reversible with rubber.



METEXP

62,00€

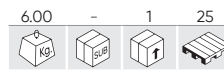

HANGING RAIL



WIPER BLADE



99%

Easy installation adapter for over 99% of vehicle applications.

38dB

The ergonomics and parts weight elimination can reduce noise to 38db.

30%

Uniform pressure along the wiper blade by the steel spring for an improved visibility compared to original blades and a performance 30% higher.

100%

100% natural rubber resistant to all extreme climatic conditions.

160km/h

Aerodynamic design that allows a use up to 160km/h.

45°

45° angle and precision-cut wiping edge to edge removes the smallest droplets.

REF.	"	mm					€
53745	11"	280mm	0.20	10	50	800	6,40€
53746	12"	310mm	0.20	10	50	800	6,40€
53747	13"	330mm	0.20	10	50	900	6,40€
53748	14"	350mm	0.20	10	50	800	6,60€
53749	15"	380mm	0.20	10	50	900	6,70€
53750	16"	410mm	0.20	10	50	900	6,70€
53751	17"	430mm	0.20	10	50	900	6,80€
53752	18"	460mm	0.25	10	50	800	6,95€
53753	19"	480mm	0.25	10	50	700	7,10€
53754	20"	510mm	0.25	10	50	900	7,40€
53755	21"	530mm	0.25	10	50	600	7,50€
53756	22"	560mm	0.25	10	50	600	7,90€
53757	24"	610mm	0.25	10	50	600	7,90€
53758	26"	650mm	0.30	10	50	600	8,20€
53759	28"	700mm	0.30	10	50	550	8,50€
53760	30"	750mm	0.30	10	50	500	9,60€

11 DIFFERENT ADAPTERS:
FOR MULTIPLE APPLICATIONS



JBMWBEXP

24,50€

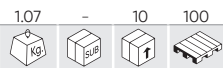

OBN WIPER BLADE DISPLAY



53919

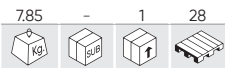

81,00€



BIKE REPAIR STAND

- Material: Q195 steel, ABS, nylon
- Dimensions assembled: 198x104cm
- Adjustable height: 107-188cm
- Rotating cross tube length: 37cm
- Leg length: 69cm
- Rotating cross tube diameter: 35mm
- Telescopic tube diameter: 35mm
- Main tube diameter: 38mm
- Leg tube diameter: 25mm
- Maximum loading weight: 30kg

MADE OF REINFORCED ABS MATERIAL AND NYLON TO ROTATE THE BIKE TO ANY ANGLE AND DO NOT DAMAGE PAINTWORKS.

WITH MULTIFUNCTIONAL PP TOOL TRAY ATTACHED 25X13CM

4 FEET ANTI-SLIP DESIGN



FOR ALL TYPES OF BICYCLE
City / road / mountain bike



Bike fixation balance pole: 50-90cm

54166

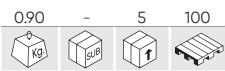

32,40€

BICYCLE FLOOR PUMP



54170

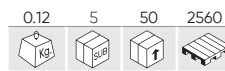

16,50€



PORTABLE BICYCLE PUMP



54073



70,00€

BIKE TOOL SET - 20PCS



54074



18,50€

MULTIFUNCTIONAL BICYCLE REPAIR TOOL



54169



13,80€

COMBINATION BIKE LOCK



VEHICLE ACCESORIES

51858

15,00€

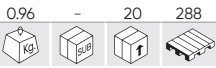

COLLAPSIBLE SHOVEL

- Made with durable metal.
- Retracted: 240mm.
- Extended: 580mm.



53033

21,50€

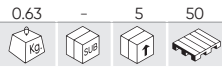

ALUMINIUM TELESCOPIC SHOVEL

- Made with plastic and aluminum.
- Retracted: 85mm.
- Extended: 119mm.



52187

21,80€

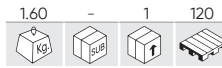

215MM WOODEN HANDLE SHOVEL



52251

21,80€

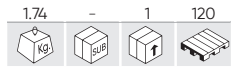

WOODEN HANDLE SHOVEL 215MM



53964

9,65€

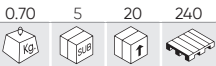

1/4" 30M MULTI-PURPOSE ROPE

ø 1/4"
550Kg



53965

25,80€

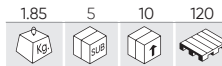

1/2" 30M MULTI-PURPOSE ROPE

ø 1/2"
1200Kg



51412

2,10€

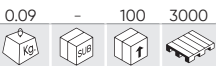

ANONYMOUS LICENCE PLATE HOLDER

- Measurements : 53,20cm x 13,70cm.
- Marking area: 52cm x 1,60cm.

FOTOLIT AND SERIGRAPHY NOT INCLUDED

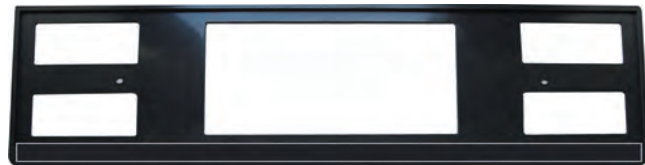

51697

0,80€



ICE REMOVER SCRAPER



50526 4,80€

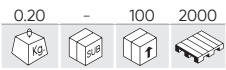

FOLDING UMBRELLA



50525 1,00€

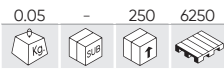

WATERPROOF CLOAK



51925 1,00€

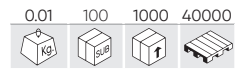

MINI SCISSORS FOR FIRST AID KIT 9CM



52618 29,00€

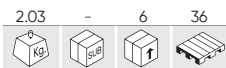

MULTIFUNCTIONAL FOLDABLE STORAGE BOX SET

- Set composed of 4 pieces:
- 37L flexible safe with lid (300mm x 490mm).
 - Circular drum with lid Ø 180mm (230mm height).
 - Object holder hanger without cover (90mm height x 260mm length).
 - Rigid tray (175mm height x 300mm wide).



53221 4,75€

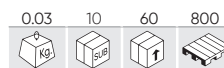

SET 3PCS MICROFIBER CLOTH

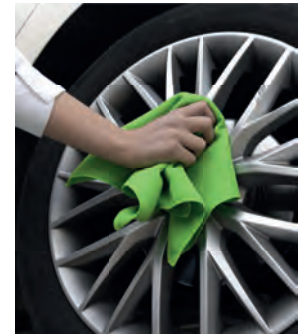

53561 28,00€



WHEEL CHOCK



53508 14,00€



WHEEL CHOCKS



REF.	DESCRIPTION	Kg	SUB	f	€
14118	WHEEL CHOCK HOLDER	1.25	4	80	26,00€

VEHICLE ACCESORIES

51863

54,00€

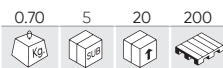

ACOUSTIC PARKING SENSOR WITH DISPLAY

- Voltage: 12V DC.
- Power: 3.6 W.
- Work temperature: - 20-70°.
- 4 nearness meters.
- Detection distance: 0.3-2.0 m.
- Detection angle: H>60°, V>60°.
- It includes nearness indicator in 2 colours.
- Black sensors: It cannot be repainted.



51973

45,00€

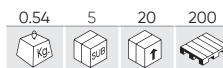

ACOUSTIC PARKING SENSOR

- Voltage: DC 12V.
- Power: 3.6 W.
- Work temperature: - 20-70°.
- 4 nearness meters.
- Detection distance: 0.3-2.0 m.
- Detection angle: H>60°, V>60°.
- Radio frequency: 315 MHz/433MHz.
- Without visual indicator.
- It includes 4 cm diameter buzzer.
- Black sensors: It cannot be repainted.



FLEX COUPLERS INNERBRAID LINER



REF.	DESCRIPTION					€
51706	Ø 25mmL x 300mmL	0.35	-	25	1500	22,80€
51707	Ø 45mmL x 100mmL	0.27	-	25	1200	9,05€
51708	Ø 45mmL x 150mmL	0.38	-	25	-	14,20€
51709	Ø 45mmL x 200mmL	0.50	-	25	-	14,70€
51710	Ø 45mmL x 250mmL	0.65	-	25	600	17,80€
51711	Ø 45mmL x 300mmL	0.71	-	25	-	21,20€
51712	Ø 50mmL x 100mmL	0.30	-	25	-	8,65€
51713	Ø 50mmL x 150mmL	0.45	-	25	-	13,10€
51714	Ø 50mmL x 200mmL	0.56	-	25	-	15,80€
51715	Ø 50mmL x 250mmL	0.70	-	25	-	20,30€
51716	Ø 50mmL x 300mmL	0.83	-	25	450	23,60€

REF.	DESCRIPTION					€
51717	Ø 55mmL x 100mmL	0.35	-	25	-	11,20€
51718	Ø 55mmL x 150mmL	0.50	-	25	-	14,80€
51719	Ø 55mmL x 200mmL	0.65	-	25	-	22,00€
51720	Ø 55mmL x 250mmL	0.85	-	25	350	23,50€
51721	Ø 55mmL x 300mmL	1.00	-	25	375	25,00€
51722	Ø 60mmL x 100mmL	0.36	-	25	750	13,10€
51723	Ø 60mmL x 150mmL	0.50	-	25	450	18,70€
51724	Ø 60mmL x 200mmL	0.66	-	25	400	24,40€
51725	Ø 60mmL x 250mmL	0.83	-	25	-	28,30€
51726	Ø 60mmL x 300mmL	0.96	-	25	250	31,40€
51727	Ø 60mmL x 400mmL	1.62	-	25	200	49,00€

AVAILABLE IN INDIVIDUAL BOXES

TYRE ACCESSORIES

368 WHEEL WEIGHTS

369 PUNCTURE REPAIR

370 TYRE VALVES

371 REMOVAL AND INSTALLATION



TYRE ACCESSORIES

51908

44,00€

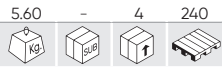

WHEEL WEIGHT DISPENSER 5GRX1.000

- 1000 x 5g bars of self-adhesive iron.
- Wheel weights with 4 mm thickness.
- Dispenser measurements: 29.5 cm x 29.5 cm.



With surplus retention magnet.

53256

34,00€

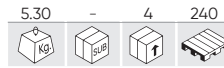

WHEEL WEIGHT DISPENSER 5G X 1.000

- 1000 x 5g bars of self-adhesive iron.
- Wheel weights with 4 mm thickness.
- Dispenser measurements: 29.5 cm x 29.5 cm.



SELF-ADHESIVE WHEEL WEIGHTS

REF.	g					€
50600	45g: 3x5g/3x10g	0.05	100	400	36000	0,60€
50601	45g: 3x5g/3x10g	0.05	100	400	48000	0,29€



50600
ZINC

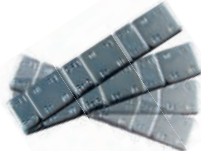

50601
STEEL

SELF-ADHESIVE IRON WHEEL WEIGHTS

REF.	g					€
52665	60g: 12x5g	0.06	100	400	20000	0,37€
52666	60g: 4x10g/4x5g	0.06	100	400	20000	0,36€



52665

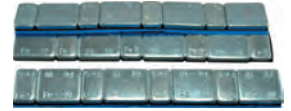

52666

ZINC CLIP-ON WHEEL WEIGHTS UNIVERSAL

WEIGHTS UNIVERSAL RIM

REF.	g					€
50760	5g	0.01	100	1600	80000	0,10€
50761	10g	0.01	100	1600	102400	0,19€
50762	15g	0.02	100	800	76800	0,29€
50763	20g	0.02	100	800	64000	0,38€
50764	25g	0.03	100	800	48000	0,49€
50765	30g	0.03	100	600	50400	0,58€
50766	35g	0.04	100	400	32000	0,68€
50767	40g	0.04	100	400	25600	0,78€
50768	45g	0.05	100	400	32000	0,88€
51055	50g	0.05	100	400	2000	0,98€



WHEEL WEIGHTS ALLOY RIM

REF.	g					€
50778	5g	0.01	100	1600	80000	0,10€
50779	10g	0.01	100	800	76800	0,19€
50780	15g	0.02	100	1200	60000	0,29€
50781	20g	0.02	100	800	80000	0,38€
50782	25g	0.03	100	600	48000	0,49€
50783	30g	0.03	100	600	30000	0,58€
50784	35g	0.04	100	400	32000	0,68€
50785	40g	0.04	100	400	32000	0,78€
50786	45g	0.05	100	400	32000	0,88€
51604	50g	0.05	100	400	25600	0,98€



UNIVERSAL CLIP-ON WHEEL WEIGHTS FOR TRUCKS

REF.	g					€
52667	50g	0.05	50	400	25600	0,76€
52668	100g	0.10	25	200	12800	1,49€
52669	150g	0.15	20	160	10240	2,22€
52670	200g	0.20	10	80	5120	2,95€
52671	250g	0.25	10	80	5120	3,70€
52672	300g	0.30	10	80	5120	4,45€



52667



52668



52669



52670



52671



52672

53864

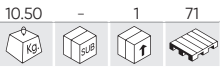

138,00€



ASSORTED WHEEL WEIGHT CASE SELECTION BOX

WHEEL WEIGHT ZINC WITH CLAMP

SELF-ADHESIVE WHEEL WEIGHTS

UNIVERSAL TYRE SPECIAL

ALLOY TYRE SPECIAL

- 5g - 20 uds (ref. 50760)
- 10g - 20 uds (ref. 50761)
- 15g - 20 uds (ref. 50762)
- 20g - 20 uds (ref. 50763)
- 25g - 20 uds (ref. 50764)
- 30g - 10 uds (ref. 50765)
- 35g - 10 uds (ref. 50766)
- 40g - 10 uds (ref. 50767)

- 5g - 20 uds (ref. 50778)
- 10g - 20 uds (ref. 50779)
- 15g - 20 uds (ref. 50780)
- 20g - 20 uds (ref. 50781)
- 25g - 20 uds (ref. 50782)
- 30g - 10 uds (ref. 50783)
- 35g - 10 uds (ref. 50784)
- 40g - 10 uds (ref. 50785)

60gr: 4x10gr 4x5gr - 70u. (ref. 52666)



51355



19,00€

WHEEL WEIGHT PLIERS



- Extracts easily and replaces the counterweight.
- Cuts and folds easily.
- Made of heat reinforced steel.
- Includes ergonomic handle.



53150

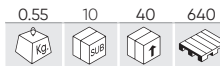

24,00€

PORTABLE AIR COMPRESSOR



54013



35,00€

PUNCTURE SEALANT KIT - LIQUID AND AIR COMPRESSOR

REF.	DESCRIPTION	Kg	SUB	QTY	PRICE
A 15317	BAG FOR KIT 54013 (53150)	0.10	-	220	4,50€
B 15300	PUNCTURE SEALANT LIQUID - 500ML	0.50	-	12	5,00€
C 11960	CORE PULLERS	0.01	10	500	1,50€
D 53150	PORTABLE AIR COMPRESSOR	0.55	10	40	24,00€

- Seals punctures up to 6mm.
- Material is non-corrosive to metal and rubber.
- Non-flammable and anti-freeze, long lasting.



51814

8,00€

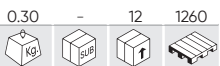

TYRE REPAIR SPRAY 300ML

300ml



52653

3,00€

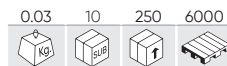

DOUBLE HEAD VALVE CORE REMOVER

- To install and remove valves core.



52652

2,80€

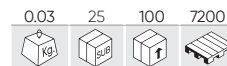

4 WAY VALVE TOOL



TYRE ACCESSORIES

52662

36,50€

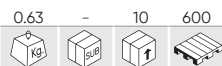

TIRE REPAIR KIT



- A 1 x perforation tool
- B 1 x wicks insertion tool
- C 1 x tool to inflate tires
- D 4 x compressed air bottles 16gr
- E 1 x cutter
- F 10 x wicks
- G 1 x tire valve core

52663

30,00€

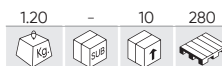

TIRE REPAIR KIT



- A 1 x wicks insertion tool
- B 1 x tip for wicks insertion tool
- C 1 x perforation tool
- D 1 x cutter
- E 20 x wicks
- F 1 x lubricant

REF.	DESCRIPTION						€
12973	WICK REPLACEMENT FOR 52662/52663	0.01	10	500	13500		1,00€
13805	WICK INSERTION AUGER (REF. 52663)	0.50	10	50	-		10,50€
13806	PERFORATION AUGER (REF. 52663)	0.35	5	50	-		10,50€

52673

18,00€

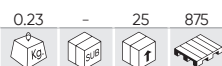

VALVE CAPS AND VALVE CORE SET



SPARE PARTS AVAILABLE

REF.	DESCRIPTION					€
11903	16 UNITS ALUMINIUM CAPS FOR VALVE TIRE	0.01	1	100		5,00€
11904	50 UNITS GREEN PLASTIC CAPS FOR VALVE TIRE	0.10	10	500		2,00€
11905	50 UNITS BLACK PLASTIC CAPS FOR VALVE TIRE	0.01	-	10		1,50€
11906	50 UNITS VALVE CORE SET	0.04	-	100		8,50€
11907	50 UNITS VALVE CORE SET HIGH PRESSURE	0.05	-	100		11,00€
11960	CORE PULLERS	0.01	10	500		1,50€

ALSO AVAILABLE:

REF.	DESCRIPTION					€
11900	SET OF 4 ALUMINIUM CAPS FOR VALVE TIRE	0.01	4	25	250	3,50€
11901	GREEN PLASTIC CAPS FOR VALVE TIRE	0.01	4	25	500	2,50€
11902	SET OF 4 BLACK PLASTIC CAPS FOR VALVE TIRE	0.01	4	25	300	3,50€

TYRE VALVES

REF.	DESCRIPTION					€
51741	TR413 45mm	0.01	100	1000	48000	0,50€
51742	TR414 51mm	0.01	100	1000	48000	0,50€
51743	TR418 64mm	0.02	100	1000	48000	0,55€



VALVE INSERTION TOOL

REF.	DESCRIPTION					€
52649	METAL	0.32	10	50	2250	5,00€
52650	PLASTIC	0.15	10	100	2400	5,00€



52657 37,50€

0.18 5 20 800

PLASTIC DUCK HEAD KIT TO REMOVE TIRES



52658 39,70€

0.17 - 20 800

PLASTIC DUCK HEAD KIT TO REMOVE TIRES



52659 39,70€

0.26 - 20 1920

PLASTIC DUCK HEAD KIT TO REMOVE TIRES



54329 37,50€

0.20 10 100 -

PLASTIC DUCK HEAD KIT TO REMOVE TIRES

N

EUR - MADE IN SPAIN

52655 39,70€

0.39 - 25 1500

TYRE BEAD BREAK PLASTIC CLAMP

155-180mm 95mm

52656 39,50€

0.40 5 20 1920

TYRE BEAD BREAK PLASTIC CLAMP

160mm 170mm 55mm

TYRE LEVER

REF.	"					€
51362	12" (30,48cm)	0.15	5	60	500	3,00€
51358	16" (40,64cm)	0.47	6	24	1008	7,50€
51359	24" (60,96cm)	0.90	6	30	1440	9,00€



CENTERING RINGS

REF.	mm					€
52645	25x22x2,5mm	0.01	50	1000	38000	0,55€
52646	25x12x2,0mm	0.00	50	1000	80000	0,50€
53037	23x12x2,5mm	0.01	50	1000	35000	0,50€
53038	21x12x2,5mm	0.01	50	1000	35000	0,50€
53039	25x19x2,5mm	0.02	50	1000	35000	0,50€
53040	25x9x2,5mm	0.01	50	1000	35000	0,50€



TYRE ACCESSORIES

52664

168,00€



TRUCK TYRE LEVER



53605

141,00€



950mm

MANUAL TYRE CHANGER

- Tyre capacity:
All tyres from 8 IN. to light truck tyres
(7- 1/2 IN. x 16 IN.)
- Flotation tyres:
Up to 12.5L 16
- Includes:
1 Bead breaker handle 37 IN.
Long Mount / Demount Tool



52660

126,00€

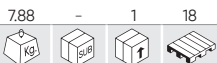

200KG TYRE CARTS



52552

128,00€



**18L AIR TYRE BEAD SEATER
BLASTER TOOL**

- 87-116 PSI
6-8 BAR
- MAX
10 BAR
145 PSI
- 18L
- 20°C
40°C



REF. DESCRIPTION

REF.	DESCRIPTION	Kg	Sub	Box	Pallet	€
13741	52552 SPARE	0.35	-	32	-	21,00€

53542

980,00€



PNEUMATIC TYRE BEAD BREAKER

- 10000 RPM
- 1/4"
- 113 L/min
- 396mm
- 80mm
- 68mm



54198

59,00€



**TYRE DOLLY WITH
CASTERS**



54136

107,00€

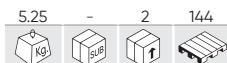

**MANUAL TYRE
CHANGER**



52842

11,00€

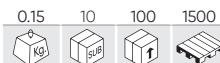

**TYRE PATCH ROLLER
38MM**



53419

9,70€

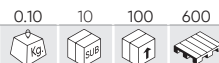

**3 PCS WHEEL RIM
PROTECTION SET**



SAFETY AND PPE

374 GLOVES/PPE

377 MASKS / DISPENSERS

379 DELIMITATION

380 OZONE METER

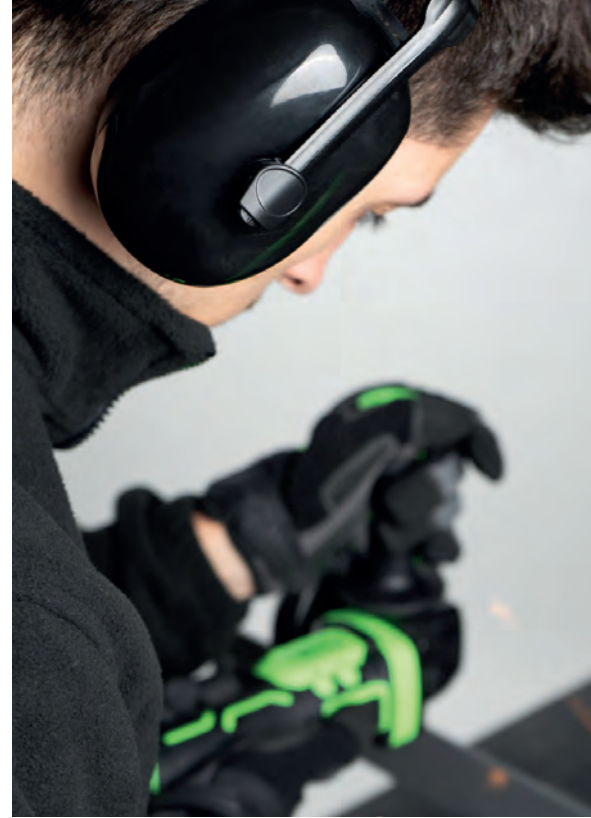



100% NITRILE GLOVES

NITRILE GLOVES

3.5MIL
4.2g

REF.	UDS.				€
54294	S	100	0.40	10 500	8,00€
53984	M	100	0.45	10 500	8,00€
53985	L	100	0.50	10 500	8,00€
53986	XL	100	0.55	10 500	8,00€



3.5MIL
4.2g

REF.	UDS.				€
54155	M	100	0.46	10 570	8,00€
54156	L	100	0.50	10 570	8,00€
54157	XL	100	0.55	10 570	8,00€



5MIL
5.5g

REF.	UDS.				€
54151	M	100	0.60	10 500	9,00€
54152	L	100	0.60	10 500	9,00€
54153	XL	100	0.60	10 500	9,00€



NITRILE GLOVES - DIAMOND TEXTURE

7MIL
8.4g

REF.	UDS.				€
53551	M	100	0.90	10 300	16,00€
53552	L	100	1.00	10 300	16,00€
53553	XL	90	1.00	10 300	16,00€



7MIL
8.4g

REF.	UDS.				€
54177	M	100	0.92	10 300	16,00€
54178	L	100	0.96	10 300	16,00€
54179	XL	90	0.97	10 300	16,00€

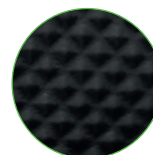

7MIL
8.4g

REF.	UDS.				€
54369	M	100	0.90	10 300	16,00€
54370	L	100	0.88	10 300	16,00€
54371	XL	100	1.05	10 300	16,00€

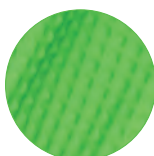

PALM POLYURETHANE COATED GLOVES

REF.						€	
51640N	T.8		0.05	12	144	3456	1,54€
51642N	T.9		0.01	12	144	3456	1,54€
51636N	T.10		0.05	12	144	3456	1,54€
51638N	T.11		0.05	12	144	3456	1,54€



PALM NITRILE COATED GLOVES

REF.						€	
51633	T.8		0.04	12	144	3456	1,54€
51634	T.9		0.05	12	144	2592	1,54€
51632N	T.10		0.05	12	144	3456	1,54€
51398N	T.11		0.05	12	144	2592	1,54€



THERMAL WORK GLOVES

REF.						€	
54192	T.8		0.15	12	144	3456	8,90€
54193	T.9		0.10	12	144	3456	8,90€
54194	T.10		0.15	12	144	3456	8,90€
54195	T.11		0.10	12	144	3456	8,90€



CUT RESISTANT GLOVES TACTILE FEATURE

REF.						€	
52570	T.8		0.03	12	144	3456	2,60€
52571	T.9		0.03	12	144	2592	2,60€
52572	T.10		0.03	12	144	2592	2,60€
52573	T.11		0.04	12	144	2592	2,60€



LEATHER GLOVES

REF.						€	
52738	T.9		0.10	12	144	2304	5,00€
52739	T.10		0.12	12	144	2304	5,00€



LEATHER AND TEXTILE GLOVES

REF.						€
52310	0.20	12	120	1920		3,65€



SAFETY AND PPE

COTTON GLOVES

REF.					€
51745	0.05	12	144	4320	0,70€



COTTON GLOVES WITH PVC DOTS

REF.					€
51785	0.04	12	300	3600	1,00€



WORK GLOVES

REF.					€	
54188	T.8	0.15	12	60	2040	19,00€
54189	T.9	0.15	12	60	720	19,00€
54190	T.10	0.15	12	60	720	19,00€
54191	T.11	0.15	12	60	720	19,00€



FOR TOUCH SCREEN



52430

10,90€

0.34	6	24	288

EAR DEFENDERS



CONFORMS TO: EN352 - 1:2003

53785

4,80€

0.05	14	112	896

ANTIFOG SAFETY GOGGLES



CONFORMS TO: EN166:2002-04

ANTIFOG SPORT PROTECTIVE GOOGLES

REF.					€
53596	0.01	12	144	2016	3,65€
53597	0.01	12	144	2016	3,70€
53598	0.01	12	144	2016	3,95€

CONFORMS TO: EN166:2002-04 / EN166:2003-01



IN 12 UNITS
DISPLAY CASE



53596



53597



53598

53794

28,00€

0.15	-	80	1280

PROFESSIONAL INFRARED THERMOMETER

- Measure body temperature in 1 second and without contact.
- Automatic shutdown after 1 minute.

RANGE	32.0°C - 42.2°C (89.6°F - 108°F)
PRECISION	±0.2°C (35°C - 42°C)



0123
2 A BATTERIES

53862

6,00€



SHOE DISINFECTANT MAT WITH TANK

- Size: 85x55x10cm
- Material: TPE
- Max. recommended capacity: 3L
- Max. capacity: 8L



53863

3,00€



DRYING MAT

- Size: 76x48cm
- Material: Polyester



53781

18,00€



AUTOMATIC SHOE COVER DISPENSER



REF. DESCRIPTION

14781 100PCS SHOE COVER



53797

0,10€

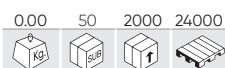

HYGIENIC INDIVIDUAL PROTECTION MASK (DAILY USE)



Presentation in box with
5 bags with 10 units each.

NON-MEDICAL USE

EBF: EFFICACY TO BACTERIAL FILTRATION	>98%
RESPIRATORY RESISTANCE	35-50 Pa

This product is neither a medical device in the meaning of the Directive 93/42 or Regulation EU / 2017/745, nor a personal protective equipment in the meaning of the Regulation EU / 2016/425. FOR PERSONAL USE, NOT REUSABLE.

53957

0,26€

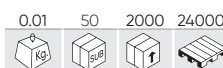

BLACK HYGIENIC INDIVIDUAL PROTECTION MASK (DAILY USE)



Presentation in box with
5 bags with 10 units each.

NON-MEDICAL USE

EBF: EFFICACY TO BACTERIAL FILTRATION	>90%
RESPIRATORY RESISTANCE	63-69 Pa

53946

0,83€



FILTERING PROTECTIVE FACE MASK FFP2 - BLACK



Approved according to EU regulation 2016/42
Complies with EN149:2001+A1:2009 regulations

SAFETY AND PPE

53826

16,00€

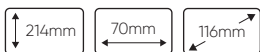
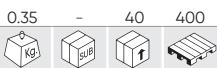

AUTOMATIC GEL DISPENSER - 400 ML

- Compatible with liquid soap, alcohol, gel and hand sanitizer.
- Infrared motion sensor blue LED indicator light.
- Dosage: 1ml.
- Voltage: 6V (4 batteries 1.5V).
- Batteries not included.



14793

12,00€



DOSING PUMP FOR 5L CANISTER



53902

25,00€

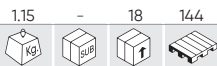

AUTOMATIC DISPENSER - 1200ML

- Liquid supply: Adjustable from 0.7ml - 1.4ml.
- Compatible with liquid soap, alcohol, gel and hand sanitizer.
- Voltage: 6V 1.5A
- Size: 160x120x295mm.
- Material: ABS.



53827

32,00€



EXTENDABLE FLOOR STANDING HAND SOAP DISPENSER

- Adjustable length: 1.25m - 1.58m
- Weight: 4.3kg
- Material: Steel
- Color: Black
- Shelf dimensions: 417x67mm
- Dispenser support dimensions: 480x133mm
- Base diameter: 395mm



REF. DESCRIPTION

REF.	DESCRIPTION	Kg	Units	€
15059	AC/DC ADAPTOR 6V 1.5A	0.10	200	10,00€
15062	R14 C1.5V CELL	0.05	24	1,00€

EXTENSIBLE
1.25m - 1.58m

53832

1,81€

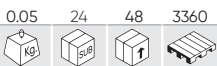

HYDROALCOHOLIC SANITIZING GEL 60ML



IN 24 UNITS DISPLAY CASE

53791

4,80€

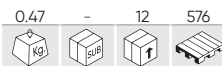

HYDROALCOHOLIC GEL 500ML



52493

4,50€

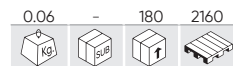

SPRAY CAN GUN



53940

13,20€

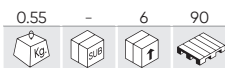

YELLOW/BLACK PLASTIC POST

- Material: PVC.
- Refillable base.

CHAIN NOT INCLUDED.



HIGH VOLTAGE AREAS SIGNALING



54322

19,00€

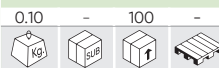

SET OF 2 HIGH VOLTAGE WARNING SIGNS



53987

9,50€

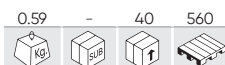

YELLOW / BLACK BARRIER TAPE - 200M

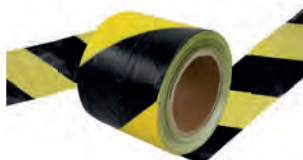

53942

0,50€

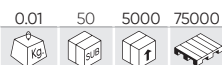

PLASTIC S-HOOK



54326

7,30€

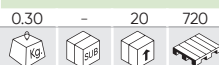

PLASTIC CHAIN - 7M YELLOW/BLACK

7m



53808

16,50€

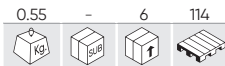

PVC CHAIN POST

- Material: PVC.
- Refillable base.



53914

75,00€



POST WITH RETRACTABLE TAPE

- Material: Steel
- Tube diameter: 63mm
- Base diameter: 320mm
- Height: 910mm

- 4-way tape output
- Tape length: 3m
- Tape width: 48mm



53811

8,90€

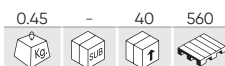

WHITE / RED BARRIER TAPE - 200M



53839

0,25€

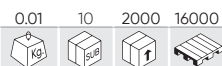

PLASTIC CARABINER



53809

8,00€



PVC CHAIN - 5M

- Length: 5m
- Link: 6mm
- Color: red / white

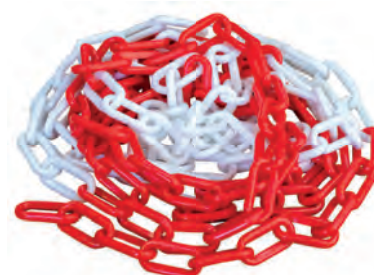

53796

76,00€



PORTABLE OZONE GENERATOR 600 MG/H (12V/220V)

TEMPORIZADOR TIMER 15W 15m³/h

O₃ 600mg/h 12V 220V

3x10⁶ ions/cm³



600mg/h

Temporizador/Timer	30/30min	60min	HOLD
--------------------	----------	-------	------

53786

98,00€

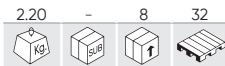

PORTABLE OZONE GENERATOR 5000 MG/H (220V)

67W 80 CFM

2 Amp 5x20mm

TEMPORIZADOR TIMER

O₃ 5000mg/h



Recommended operating time for different room volume:

5.000mg/h

50m ³	20 min
100m ³	40 min
150m ³	60 min
200m ³	80 min
300m ³	100 min

REF.	DESCRIPTION	Icons	€
14775	SPARE PLATE FOR PORTABLE OZONE GENERATOR (REF.53786)	0.02 - 1 -	30,50€

53806

250,00€

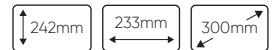
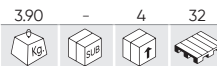

PORTABLE OZONE GENERATOR 20000 MG/H (220V)

TEMPORIZADOR TIMER 190W 50 dB

O₃ L:1000mg/h H:20000mg/h 220V 240V 120 CFM

O₃ 2000mg/h



Recommended operating time for different room volume:

Room Volume	10.000mg/h	20.000mg/h
50m ³	8 min	500m ³ 30 min
100m ³	16 min	600m ³ 40 min
150m ³	24 min	700m ³ 50 min
200m ³	32 min	800m ³ 60 min
300m ³	48 min	900m ³ 70 min
500m ³	65 min	1.000m ³ 80 min

REF.	DESCRIPTION	Icons	€
14803	SPARE PLATE FOR PORTABLE OZONE GENERATOR	0.03 - 50 -	43,00€

53838

38,00€

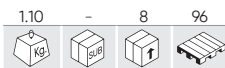

OZONE TREATMENT BOX

12V Amp 0.38 0.42

5V UV 1550 μW/cm² 2W

O₃ 1.5-2.0mg/h

3 MIN



- UV Wavelength: UV: 254nm.
- Power supply: Micro-USB connector.
- The box is very easy to assemble and disassemble, making it convenient to transport.

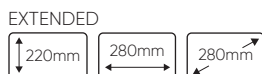

53802

120,00€

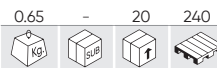

OZONE METER

- Accuracy: ±5% F.S.
- Measuring range: 0-50ppm (0-98mg/m³)
- Low alarm: 5ppm (9.8mg/m³)
- High alarm: 10ppm (19.6 mg/m³)
- Response time: <30 seconds
- Operating temperature: -10°C - 55°C
- IP65 protection.



TWO CONFIGURABLE ALARM LEVELS FOR DIFFERENT CONCENTRATION LEVELS

WORKING TIME: >8H
CHARGING TIME: 4H-6H



COMPLIES WITH: EN61326-1, EN61000-4-2, EN61000-4-3

CONSUMABLES

- 383 PINS AND CIRCLIPS
- 384 WASHERS
- 384 SCREWS NUT WASHERS
- 388 CRANKCASE AND ENGINE WASHERS
- 391 OTHERS
- 391 GASKETS AND O-RINGS
- 392 HOSE CONNECTORS
- 393 ELECTRICAL
- 396 PLASTIC CLIPS AND STAPLES



CONSUMABLES

52044

19,00€

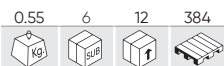

R-CLIP ASSORTMENT 150 PIECES



REF.	Image	PCS	€
10793		2,3x43	25 0,25€
10794		3,2x52	20 0,40€
10795		3,8x75	8 0,60€
10882		2x32	42 0,25€
10883		1,6x36	30 0,25€
10884		1,6x42	25 0,25€

52027

14,00€

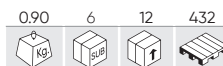

365 PIECE PIN ASSORTMENT



REF.	Image	PCS	€
10796		1,2x25	50 0,07€
10797		1,6x32	50 0,09€
10798		2x40	50 0,12€
10799		2,5x40	50 0,13€
10800		3,2x40	50 0,15€
10801		3,2x50	50 0,17€
10802		4x50	40 0,19€
10803		5x63	10 0,05€
10804		6,3x63	15 0,22€

53348

14,00€

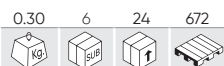

E-CIRCLIP ASSORTMENT



Image	PCS
M1.5 - 1/16"	15
M3 - 1/8"	15
M5 - 3/16"	20
M6 - 1/4"	25
M9 - 3/8"	25
M12 - 1/2"	20
M15 - 5/8"	10
M19 - 3/4"	10
M22 - 7/8"	10

53350

14,00€



ROLL PIN ASSORTMENT



1/16" x 3/16"	4	3/16" x 5/8"	5
1/16" x 5/16"	4	3/16" x 1"	5
1/16" x 3/4"	4	3/16" x 1-1/4"	5
5/64" x 1/4"	4	7/32" x 5/8"	4
5/64" x 1/2"	4	7/32" x 1-1/4"	4
5/64" x 1"	4	7/32" x 1-3/4"	4
3/32" x 5/8"	4	1/4" x 5/8"	4
3/32" x 1"	4	1/4" x 1-1/4"	4
3/32" x 1-1/4"	4	1/4" x 1-3/4"	4
1/8" x 5/8"	5	5/16" x 3/4"	4
1/8" x 1"	5	5/16" x 1-1/2"	4
1/8" x 1-1/4"	5	5/16" x 2"	4
5/32" x 5/8"	4	3/8" x 3/4"	2
5/32" x 1"	4	3/8" x 1-1/2"	2
5/32" x 1-1/2"	4	3/8" x 2"	2

53363

34,00€



CLEVIS PIN AND R-CLIP ASSORTMENT



Image	PCS
3.5x44	6
2.5x42	20
2.5x58	7
2x3	7
8x50	5
9.5x50	18
11x63	5
12.5x50	3

53364

16,00€



MACHINE KEY ASSORTMENT



Image	PCS
3x3x25	4
3x3x20	4
5x5x30	5
5x5x25	5
5x5x20	5
6x6x40	5
6x6x30	5
6x6x20	5
8x8x40	5
8x8x30	5
10x10x40	5
10x10x30	5
12x12x40	2

53371

29,00€

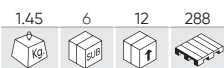

LYNCH PIN ASSORTMENT

50 PCS



	PCS
5x36	16
6x45	18
8x45	6
11x45	10

53372

26,00€



SS COTTER PIN ASSORTMENT

144 PCS



	PCS
M3x50	50
M4x60	30
M5x75	20
M6x50	20
M6x75	16
M8x60	8

53373

14,50€

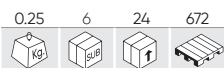

STARLOCK WASHER ASSORTMENT

260 PCS



	PCS
M3x10	30
M4x12	30
M5x14	40
M6x14	50
M8x18	50
M10x20	40
M12x25	20

53383

11,50€

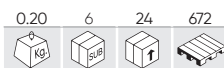

EXTERNAL SNAP RING ASSORTMENT

300 PCS



	PCS
M4	50
M6	40
M8	45
M10	30
M12	30
M14	25
M16	25
M18	25
M20	15
M22	15

53382

11,00€



INTERNAL SNAP RING

300 PCS



	PCS
M4	50
M6	40
M8	45
M10	30
M12	30
M14	25
M16	25
M18	25
M20	15
M22	15

52711

27,50€



PLASTIC RIVET ASSORTMENT (150 PCS)

150 PCS



REF.		PCS	€
13674	6x19,3mm	25	0,50€
13675	6x17,8mm	25	0,50€
13676	6x25,5mm	25	0,50€
13677	6x24,5mm	25	0,50€
13678	6x24mm	50	0,50€

CONSUMABLES

52703

22,00€

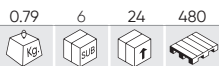

NUT RIVET ASSORTMENT 235PCS



REF.	Image	PCS	€
13235	M3	50	0,15€
13236	M4	50	0,15€
13237	M5	50	0,15€
13238	M6	40	0,20€
13239	M8	20	0,20€
13240	M10	15	0,40€
13241	M12	10	0,55€

53360

18,00€

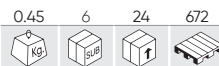

ZINC KNURLED RIVET NUT ASSORTMENT



Image	PCS
3x9	40
4x11	35
5x13	25
6x15	25
8x18	15
10x21	10

53361

24,00€



ALUMINIUM KNURLED RIVET NUT ASSORTMENT



Image	PCS
3x9	40
4x11	35
5x13	25
6x15	25
8x18	15
10x21	10

52043

16,50€

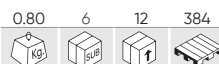

RIVET ASSORTMENT 300 PIECES



REF.	Image	PCS	€
10877	4,8x16,90mm	50	0,25€
10878	4,8x24,80mm	40	0,30€
10879	3,2x9,70mm	90	0,20€
10880	4,8x12,70mm	70	0,20€
10881	4,80x20mm	50	0,25€

53351

12,50€

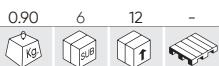

METRIC HEX HEAD SCREW ASSORTMENT



Image	PCS	Image	PCS
M4x12	10	M4	20
M4x20	10	M5	20
M5x16	10	M6	20
M5x25	10	M8	10
M6x20	10	M10	10
M6x30	10		
M8x25	5	PCS	
M8x40	5	M4	20
M10x16	5	M5	20
M10x40	5	M6	20
		M8	10
		M10	10

53354

14,00€

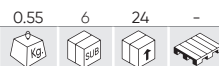

HEX HEAD DRILL SCREW ASSORTMENT



Image	PCS
#8x12.5	30
#8x16	30
#8x19	30
#8x25	30
#10x12.5	20
#10x16	20
#10x19	20
#10x25	20

53362

14,00€

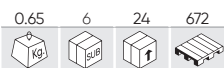

ALLEN CAP SCREW ASSORTMENT



	PCS
4x12	25
5x12	25
5x25	20
10x40	3
6x25	10
8x40	5
10x25	3
6x12	10
8x25	5

53365

14,00€

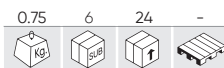

METRIC WING NUT ASSORTMENT



	PCS
M4	40
M5	40
M6	25
M8	25
M10	20

53366

14,00€



U-CLIP AND SCREW ASSORTMENT



	PCS
M3.5x8	40
M4.2x16	20
M5x12	15
M6.35x19	10
M3.5	20
M3.5 Con muesca/with notch	20
M4	20
M5	15
M6.35	10

53369

14,00€



FLAT HEAD SELF TAPPING SCREW ASSORTMENT



	PCS
2.8x13mm	65
2.8x16mm	55
3.5x10mm	60
3.5x13mm	65
3.5x16mm	60
3.5x19mm	45
4.2x13mm	50
4.2x16mm	40
4.2x25mm	30
4.2x31mm	20
4.8x19mm	25
4.8x25mm	20
4.8x32mm	15

52029

14,00€



SELF-LOCKING NUT ASSORTMENT 228U.



	PCS
M3	50
M4	50
M5	40
M6	30
M8	20
M10	15
M12	10
M14	8
M16	5

52028

15,20€



NUT CASE ASSORTMENT 243U.



REF.		PCS	€
10805	M3	50	0,10€
10779	M4	50	0,05€
10780	M5	50	0,05€
10781	M6	30	0,05€
10784	M8	20	0,05€
10785	M10	20	0,10€
10786	M12	10	0,15€
10812	M14	8	0,30€
10813	M16	5	0,30€

CONSUMABLES

52032

28,00€

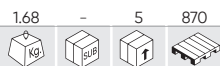

BLACK GROWER WASHERS ASSORTMENT - 1.735 PIECES

1735 PCS



	PCS
3mm	600
4mm	400
5mm	220
6mm	220
8mm	110
10mm	65
12mm	50
14mm	40
16mm	30



53377

20,00€

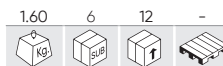

FLAT WASHER ASSORTMENT

240 PCS



	PCS
20x6x1.5	20
20x8x1.5	20
20x10x1.5	20
25x6x1.5	20
25x8x1.5	20
25x10x1.5	20
32x2x1.5	20
32x4x1.5	20
32x6x1.5	20
32x8x1.5	20
32x10x1.5	20
32x10x1.5	20



52158

38,50€



GALVANIZED IRON FLAT WASHER ASSORTMENT 475PCS

475 PCS

	PCS		PCS
5x20x1.5	50	6x30x2	25
6x20x1.5	50	7x30x2	25
7x20x1.5	50	8x30x2	25
8x20x1.5	50	4x11x0.98	50
8x25x1.75	50	12x40x3	25
10x30x2.5	25	4x20x1.5	50



51804

58,00€



SCREWS, NUTS AND WASHERS ASSORTMENT

828 PCS

REF.	DESCRIPTION	PCS	€
10772	ZINC-PLATED SCREW DIN 933 8.8 M4X25	25	0,05€
10773	ZINC-PALTED SCREW DIN 933 8.8 M5X50	25	0,10€
10774	ZINC-PLATED SCREW DIN 933 8.8 M6X50	25	0,10€
10775	ZINC-PLATED SCREW DIN 933 8.8 M7X50	15	0,15€
10776	ZINC-PLATED SCREW DIN 933 8.8 M8X50	15	0,20€
10777	ZINC-PLATED SCREW DIN 933 8.8 M10X50	12	0,20€
10778	ZINC-PLATED SCREW DIN 933 8.8 M12X60	20	0,35€
10779	ZINC-PLATED NUT DIN 934 M4	50	0,05€
10780	ZINC-PLATED NUT DIN 934 M5	50	0,05€
10781	ZINC-PLATED NUT DIN 934 M6	50	0,05€
10782	ZINC-PLATED NUT DIN 934 M7	50	0,05€
10783	ZINC-PLATED WASHER DIN 125 M12	50	0,05€
10784	ZINC-PLATED NUT DIN 934 M8	50	0,05€
10785	ZINC-PLATED NUT DIN 934 M10	50	0,10€
10786	ZINC-PLATED NUT DIN 934 M12	40	0,15€
10787	ZINC-PLATED WASHER DIN 125 M4	50	0,05€
10788	ZINC-PLATED WASHER DIN 125 M5	50	0,05€
10789	ZINC-PLATED WASHER DIN 125 M6	50	0,05€
10790	ZINC-PLATED WASHER DIN 125 M7	50	0,05€
10791	ZINC-PLATED WASHER DIN 125 M8	50	0,05€
10792	ZINC-PLATED WASHER DIN 125 M10	50	0,05€

REF.	DESCRIPTION	PCS	€
50959	20 + 1 COMPARTMENT BOX	1	14,00€



53464

153,00€



551 PCS

INJECTOR COPPER RING ASSORTMENT 551 PCS

SPARE PARTS AVAILABLE

REF.	DESCRIPTION	PCS	€
13945	Ø15.0x8.0x1.5 - UNIVERSAL	30	7,40€
13946	Ø15.0x7.0x1.5 - MERCEDES	12	6,70€
13947	Ø13.0x7.5x2.5 - RENAULT	30	5,85€
13948	Ø15.0x7.5x1.5 - IVECO, FORD, BMW, MAN	30	5,00€
13949	Ø15.0x7.5x2.0 - IVECO, FORD, BMW, MAN	30	6,50€
13950	Ø15.45x8.0x2.0 - UNIVERSAL	30	7,80€
13951	Ø13.5x10x2.0 - MAZDA (REF.. 53464)	12	5,15€
13952	Ø15.5x7.5x2.5 - FORD	30	10,90€
13953	Ø15.5x7.5x1.5 - LAND ROVER	12	8,00€
13954	Ø15.0x7.5x3.0 - RENAULT	30	12,70€
13955	Ø13.0x7.0x1.5 - DEUTZ	12	4,95€
13956	Ø13.5x7.5x1.5 - FORD	30	4,30€
13957	Ø15.0x7.5x1.5 - FIAT	12	9,70€
13958	Ø15.5x7.5x1 - MAN ROVER	12	5,45€
13959	Ø16.5x7.5x2 - MERCEDES	30	10,10€
13960	Ø13.7x7.3x3 - KIA	12	9,65€
13961	Ø13.7x7.3x2 - KIA	12	9,25€
13962	Ø10x6.0x1.0	50	1,7€
13963	Ø15.8x7.5x3.0	30	12,40€
13964	30 PLASTIC NOZZLE T-TYPE BAG (REF.53464)	20	15,00€
13965	Ø8x5.8x1	30	1,50€
13966	30 PLASTIC NOZZLE L-TYPE BAG (REF.53464)	30	12,90€
13967	30 SPRING BAG (REF.53464)	25	4,65€



52031

44,00€



ALUMINIUM FLAT WASHER ASSORTMENT 900 PIECES



Ø	PCS
3x7x1.5	50
4x8x1.5	50
5x6x1.5	50
16x22x1.5	50
14x22x1.5	50
14x20x1.5	50
6x10x1.5	50
6x11x1.5	50
7x11x1.5	50
7x12x1.5	50
8x12x1.5	50
8x14x1.5	50
9x12x1.5	50
10x14x1.5	50
11x16x1.5	50
11x17x1.5	50
12x16x1.5	50
12x18x1.5	50



53353

18,00€



COPPER WASHER ASSORTMENT



Ø	PCS
M6	30
M8	25
M10	20
M12	15
M14	10
M16	10



52163

95,00€

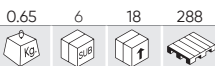

OIL DRAIN PLUG COOPER WASHER ASSORTMENT



SPARE PARTS AVAILABLE

REF.	mm	PCS	€
51538	Ø 10mm	100	0,15€
51539	Ø 12mm	100	0,15€
51540	Ø 14mm	100	0,15€
51541	Ø 16mm	100	0,25€
51542	Ø 18mm	100	0,20€
51543	Ø 20mm	25	0,25€

YOU MAY ALSO LIKE...

REF.	mm	PCS	€
51544	Ø 22mm	100	0,25€
51545	Ø 26mm	100	0,30€

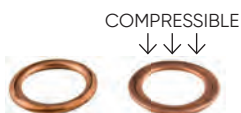

52030

98,00€



COPPER 18 - WASHER ASSORTMENT 900 PIECES



SPARE PARTS AVAILABLE

REF.	mm	PCS	€
10823	3x7x1,5mm	50	0,20€
10824	4x8x1,5mm	50	0,20€
10825	5x6x1,5mm	50	0,20€
10826	16x22x1,5mm	50	0,40€
10827	14x22x1,5mm	50	0,60€
10828	14x20x1,5mm	50	0,45€
10829	6x10x1,5mm	50	0,20€
10830	6x11x1,5mm	50	0,20€
10831	7x11x1,5mm	50	0,20€

REF.	mm	PCS	€
10832	7x12x1,5mm	50	0,20€
10833	8x12x1,5mm	50	0,20€
10834	8x14x1,5mm	50	0,25€
10835	9x12x1,5mm	50	0,25€
10836	10x14x1,5mm	50	0,30€
10837	11x16x1,5mm	50	0,30€
10838	11x17x1,5mm	50	0,30€
10839	12x16x1,5mm	50	0,40€
10840	12x18x1,5mm	50	0,35€



INJECTOR COPPER WASHERS ASSORTMENT

53229

38,70€



PCS	PCS
13,8 x 7,3 x 1,4mm 10	15,0 x 7,5 x 3,0mm 10
14,6 x 7,5 x 1,3mm 10	15,5 x 7,5 x 2,0mm 10
14,6 x 7,5 x 3,0mm 10	16,0 x 7,5 x 1,5mm 10
15,0 x 7,0 x 2,0mm 10	16,0 x 7,5 x 1,7mm 10
15,0 x 7,5 x 1,0mm 10	16,0 x 7,5 x 2,0mm 10
15,0 x 7,5 x 1,5mm 10	16,4 x 7,5 x 2,0mm 10
15,0 x 7,5 x 2,0mm 10	20,0 x 9,4 x 0,9mm 10
15,0 x 7,5 x 2,5mm 10	



53340

86,00€



PCS	PCS
13,8 x 7,3 x 1,4mm 25	15,0 x 7,5 x 3,0mm 25
14,6 x 7,5 x 1,3mm 25	15,5 x 7,5 x 2,0mm 25
14,6 x 7,5 x 3,0mm 25	16,0 x 7,5 x 1,5mm 25
15,0 x 7,0 x 2,0mm 25	16,0 x 7,5 x 1,7mm 25
15,0 x 7,5 x 1,0mm 25	16,0 x 7,5 x 2,0mm 25
15,0 x 7,5 x 1,5mm 25	16,4 x 7,5 x 2,0mm 25
15,0 x 7,5 x 2,0mm 25	20,0 x 9,4 x 0,9mm 25
15,0 x 7,5 x 2,5mm 25	



53229 - 53340 SPARE PARTS AVAILABLE

REF.	mm	PCS	€
13819	13,8 x 7,3 x 1,4mm	50	6,50€
13820	14,6 x 7,5 x 1,3mm	50	7,00€
13821	14,6 x 7,5 x 3,0mm	50	14,00€
13822	15,0 x 7,0 x 2,0mm	50	11,00€

REF.	mm	PCS	€
13823	15,0 x 7,5 x 1,0mm	50	6,00€
13824	15,0 x 7,5 x 1,5mm	50	8,00€
13825	15,0 x 7,5 x 2,0mm	50	11,50€
13826	15,0 x 7,5 x 2,5mm	50	13,00€

REF.	mm	PCS	€
13827	15,0 x 7,5 x 3,0mm	50	15,00€
13828	15,5 x 7,5 x 2,0mm	50	11,50€
13829	16,0 x 7,5 x 1,5mm	50	10,50€
13830	16,0 x 7,5 x 1,7mm	50	10,50€

REF.	mm	PCS	€
13831	16,0 x 7,5 x 2,0mm	50	12,60€
13832	16,4 x 7,5 x 2,0mm	50	13,00€
13833	20,0 x 9,4 x 0,9mm	50	9,00€

54390

199,00€



N

SET OF FUEL CONNECTORS AND TUBES (95 PCS)

SPARE PARTS AVAILABLE

REF.	mm	PCS	€	REF.	mm	PCS	€
16462	6,3x6mm	3	36,50€	16538	7,5x200mm	3	19,50€
16463	7,89x8mm	3	36,50€	16539	12x200mm	1	18,00€
16464	9,49x8 mm	3	36,50€	16540		1	13,00€
16465	9,89x8 mm	3	39,50€	16541	6x340mm	2	13,00€
16466	11,80x10mm	3	50,00€	16542	8x340mm	6	23,50€
16467	6,3x6 mm	3	36,50€	16543	9,5x340mm	2	13,00€
16468	7,89x8 mm	3	36,50€				
16469	9,49x8 mm	3	36,50€				
16470	9,89x8 mm	3	39,50€				
16471	11,8x10mm	3	50,00€				
16472	6,3x6 mm	5	17,50€				
16473	7,89x8mm	5	17,50€				
16474	9,49x8 mm	5	17,50€				
16475	9,89x8mm	5	17,50€				
16476	11.8x10 mm	5	24,00€				
16477	6x7,5mm	3	24,50€				
16478	8x7,5mm	6	24,50€				
16479	15 - 18mm	12	7,50€				
16480	17-20mm	4	7,50€				

95 PCS



OIL DRAIN PLUG GASKETS

REF.	DESCRIPTION					€
52719	OIL DRAIN PLUG GASKET 10MM DIAM.	0.00	100	5000	150000	0,19€
51843	OIL DRAIN PLUG GASKET 12MM DIAM.	0.01	100	5000	200000	0,19€
51554	OIL DRAIN PLUG GASKET (FORD) 13MM DIAM.	0.00	100	5000	180000	0,28€
51546	OIL DRAIN PLUG GASKET 14MM DIAM.	0.00	100	5000	150000	0,19€
51799	OIL DRAIN PLUG GASKET 16MM DIAM.	0.01	100	120000	120000	0,20€



53599

30,30€

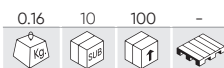

CAR AIR CONDITIONING SCHRADER VALVE CORE SET

134 PCS

SPARE PARTS AVAILABLE

REF.	mm	PCS	€	REF.	mm	PCS	€
14594	5x19mm R12	50	2,00€	14599	7x20mm R134A	10	4,50€
14595	5x19mm	30	1,50€	14600	6x22mm	5	9,50€
14596	5x19mm R12	30	2,00€	14601	8x22mm	1	11,00€
14597	6x19mm	3	7,60€	14602	9x22mm	4	11,00€
14598	6x26mm	1	17,80€				



CONSUMABLES

53358

11,50€

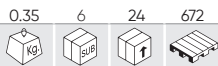

SPRING ASSORTMENT



	PCS		PCS
5/16x1-3/4	12	13/64x13/16	10
		7/32x1	10
		1/4x7/8	10
9/32x1/2	10	5/16x1-1/8	8
1/4x13/32	10	5/16x1-1/4	10
7/32x11/16	10	3/16x1-3/4	8
7/32x1-1/2	10	9/32x1-1/2	10
3/8x5/8	6	11/32x1-7/16	10
3/8x3/4	12	11/32x1-27/32	12
23/64x1-3/8	8	9/32x2	12
9/32x3/4	10	5/32x3-1/8	12



53352

12,00€

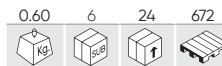

EYE BOLT ASSORTMENT



	PCS
2.4x41	50
4x64	12
4.2x85	5

	PCS
2.4x25	60
4x45	12
4x50	12



52033

43,00€

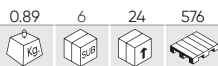

GREASE NIPPLE FITTING ASSORMENT - 135 PIECES



REF.	90°	PCS	€
10874	6x1	20	0,30€
10875	8x1	15	0,40€
10876	10x1	10	0,45€

REF.	RIGHT ANGLE	PCS	€
10868	6x1	20	0,30€
10869	8x1	15	0,30€
10870	10x1	10	0,45€

REF.	45°	PCS	€
10871	6x1	20	0,30€
10872	8x1	15	0,40€
10873	10x1	10	0,45€



53359

16,00€

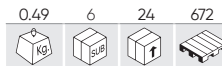

GREASE NIPPLE FITTING ASSORMENT



90°	PCS
6x1	60
8x1.25	10
10x1.5	10

RIGHT ANGLE	PCS
6x1	5
8x1.25	5
10x1.5	5

45°	PCS
6x1	5
8x1.25	5
10x1.5	5



53378

13,00€



HOSE CLAMP ASSORTMENT 20 PCS



	PCS
1"	4
2-1/2"	2
1-1/4"	2
3"	2
1-3/4"	2
3-1/2"	2
2"	4
4"	2



53381

14,50€

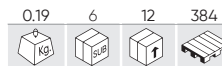

FIBRE WASHER ASSORTMENT 600 PCS



	PCS
10x5.5x1	160
16x10x1	80
19x12x1	40
22x16x1	30
22.5x14x1	20
32x22x1	20
12x6.5x1	100
16x8x1	60
20x12.5x1	40
27x20x1	20
25.4x17.5x1	15
32x24x1	15



50651

18,00€

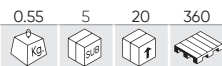

METRIC O-RING SEALING GASKET WASHER SET



	CASE TOP						CASE BASE					
POSITION IN CASE	006	007	008	009	010	011	211	212	213	214	215	216
RUBBER WIDTH (MM)	2	2	2	2	2	2	3	3	3	3	3	3
Ø INNER (MM)	A 3	4	5	6	7	8	D 20	22	24	25	27	28
QUANTITY	16	16	16	16	16	16	12	12	12	12	12	12
POSITION IN CASE	113	112	111	110	012	221	220	219	218	217		
RUBBER WIDTH (MM)	B 2.5	2.5	2.5	2.5	2	E 3	3	3	3	3		
Ø INNER (MM)	14	12	11	10	10	36	35	33	32	30		
QUANTITY	13	13	13	13	17	12	12	12	12	12		
POSITION IN CASE	114	115	116	210	222	325	326	327				
RUBBER WIDTH (MM)	C 2.5	2.5	2.5	3	F 3	4	4	4				
Ø INNER (MM)	16	17	19	19	38	38	41	44				
QUANTITY	13	13	13	10	12	10	9	9				



50652

16,50€

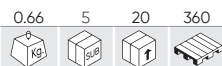

IMPERIAL O-RING SEALING GASKET WASHER SET



	CASE TOP						CASE BASE					
POSITION IN CASE	006	007	008	009	010	011	211	212	213	214	215	216
RUBBER WIDTH (MM)	A 1/16	1/16	1/16	1/16	1/16	1/16	D 1/8	1/8	1/8	1/8	1/8	1/8
Ø INNER (MM)	1/8	5/32	3/16	7/32	1/4	5/16	13/16	7/8	15/16	1	11/16	11/18
QUANTITY	20	20	20	20	20	20	10	10	10	10	10	10
POSITION IN CASE	113	112	111	110	012	221	220	219	218	217		
RUBBER WIDTH (MM)	B 3/32	3/32	3/32	3/32	1/16	E 1/8	1/8	1/8	1/8	1/8		
Ø INNER (MM)	9/16	1/2	7/16	3/8	3/8	17/16	13/8	15/16	11/4	13/16		
QUANTITY	13	13	13	13	13	10	10	10	10	10		
POSITION IN CASE	114	115	116	210	222	325	326	327				
RUBBER WIDTH (MM)	C 3/32	3/32	3/32	1/8	F 1/8	3/16	3/16	3/16				
Ø INNER (MM)	5/8	11/16	3/4	3/4	11/2	11/2	15/8	13/4				
QUANTITY	13	13	13	10	10	7	7	7				
QUANTITY												



50807

38,00€

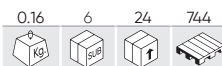

AIR CONDITIONING RUBBER O-RING ASSORTMENT 270PCS



Ø	PCS	Ø	PCS	Ø	PCS
5.29x1.78	20	8.80x1.90	20	13.95x2.62	10
6.07x1.78	20	10.82x1.78	15	14.0x2.0	10
6.8x1.9	20	10.77x2.62	15	15.0x2.0	10
7.65x1.78	20	11.0x2.0	15	17.0x2.0	10
7.80x1.90	20	12.0x2.0	15	17.17x1.78	10
8.0x2.0	20	13.9x1.80	10	17.04x3.53	10



CONSUMABLES

53910

19,00€

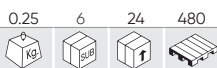

VACUUM CONNECTOR ASSORTMENT 113 PCS



STRAIGHT

4.8x4.8	10
6.3x6.3	8
7.9x7.9	6
9.5x9.5	6
3.17x3.17	30

TEE

3.9x3.9x3.9	8
4.8x4.8x4.8	8
6.3x6.3x6.3	6
9.5x9.5x9.5	3
3.17x3.17x3.17	12

REDUCER

9.5x6.3	6
6.3x4.8	10



53434

18,00€

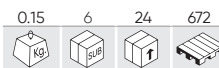

VACUUM CONNECTOR ASSORTMENT SET 65 PCS



PCS

4x28.7	10
3.9x30.8	5
10.4x4.4	10
5.6x47.1	5
7.9x38	10
4.7x38.9	5
5.2x33.9	10
7x30	10



53992

18,00€



HEAT SHRINKA SOLDER SLEEVE SET 100PCS



Ø1.7mm / 0.25-0.34mm ² / 26-24 AWG	25
Ø2.7mm / 0.5-1.0mm ² / 22-18 AWG	35
Ø4.7mm / 1.5-2.5mm ² / 16-14 AWG	30
Ø6.0mm / 4.0-6.0mm ² / 12-10 AWG	10

53349

14,00€

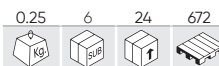

RUBBER GROMMET ASSORTMENT



OPEN RUBBER GROMMETS:	PCS	CLOSED RUBBER GROMMETS:	PCS
M19,5x23	2	M25	2
M16x24	3	M22	3
M13x15	3	M19	4
M11,5x19	4	M15	5
M10x20	3	M12	10
M10x12	5	M9	20
M9,8x11,5	6	M7	20
M8x14	3		
M7,5x13	7		
M6x7,5	10		
M3,5x6	15		



53374

10,00€



HEATING TUBE ASSORTMENT



REF.	DESCRIPTION	PCS
M2x40		30
M2.5x40		25
M3.5x40		20
M5x40		20
M7x80		16
M10x80		8
M13x85		8



53376

10,50€



RED HEATING TUBE ASSORTMENT



REF.	DESCRIPTION	PCS
M2x40		30
M2.5x40		25
M3.5x40		20
M5x40		20
M7x80		16
M10x80		8
M13x85		8



REF. DESCRIPTION

51920 GAS TORCH

0.14 10 100 400 18,00€

53370 26,00€

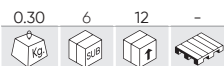

SECURITY SCREW WITH WHITE FLIP TOP CAP - M2,3,4,5,6,8,10



	PCS
M2	25
M3	25
M4	30
M5	30
M6	30
M8	20
M10	20

53355 11,50€

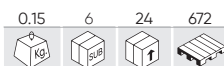

MINI FUSE ASSORTMENT



	PCS
5A	20
10A	20
15A	20
20A	20
25A	20
30A	20

53356 11,50€



AUTO FUSE ASSORTMENT



REF.		PCS	€
10915	5A	20	0,25€
10917	10A	20	0,30€

REF.		PCS	€
10918	15A	20	0,30€

REF.		PCS	€
10919	20A	20	0,30€
10920	25A	20	0,25€
10921	30A	20	0,30€

53367 9,50€



AUTO FUSE ASSORTMENT



	PCS
5A	8
10A	8
15A	8

	PCS
20A	8
25A	8
30A	8

53368 9,00€



MINI FUSE ASSORTMENT



	PCS
5A	8
10A	8
15A	8
20A	8
25A	8
30A	10

53380 11,50€



MINI FUSE ASSORTMENT



	PCS
5A	20
10A	20
15A	20
20A	20
25A	20
30A	20

CONSUMABLES

52054

17,00€

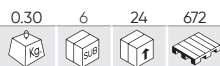

252 PCS FUSE ASSORTMENT



REF.	Icon	PCS	€
10905	3A	20	0,25€
10906	4A	20	0,25€
10907	5A	20	0,25€

REF.	Icon	PCS	€
10908	7,5A	20	0,30€
10909	10A	20	0,30€
10910	15A	20	0,30€

REF.	Icon	PCS	€
10911	20A	20	0,30€
10912	25A	20	0,25€
10913	30A	20	0,30€

REF.	Icon	PCS	€
10914	4A	8	0,25€
10915	5A	8	0,25€
12954	3A	8	0,25€

REF.	Icon	PCS	€
10916	7,5A	8	0,30€
10917	10A	8	0,30€
10918	15A	8	0,30€

REF.	Icon	PCS	€
10919	20A	8	0,30€
10920	25A	8	0,25€
10921	30A	8	0,30€



52053

45,00€

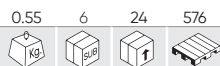

635 PIECE INSULATED ELECTRICAL WIRE CONNECTOR ASSORTMENT



REF.	Icon	PCS	€
10885	RV1.25-4S	50	0,20€
10886	RV2-4S	50	0,20€
10887	RV2-6S	30	0,25€
10888	RV5.5-6S	20	0,30€
10889	RV5.5-5S	20	0,30€
10893	RV2-5S	40	0,25€

REF.	Icon	PCS	€
10894	SV1-4S	50	0,20€
10895	SV2-4S	40	0,20€

REF.	Icon	PCS	€
10896	FDD1.25-250	45	0,30€
10898	FDD2-250	40	0,30€
10900	FDD5.5-250	25	0,30€

REF.	Icon	PCS	€
10890	BV5.5	15	0,35€
10891	BV2	25	0,25€
10892	BV1.25	30	0,30€

REF.	Icon	PCS	€
10897	MDD1.25-250	50	0,30€
10899	MDD2-250	50	0,30€
10901	MDD5.5-250	30	0,25€

REF.	Icon	PCS	€
10902	FDN 1.25-250	25	0,30€



CRIMPING TOOL

PAGE 61



53357

7,00€



ELECTRICAL CLIP ASSORTMENT



53385

19,30€



TRIM CLIP REMOVER



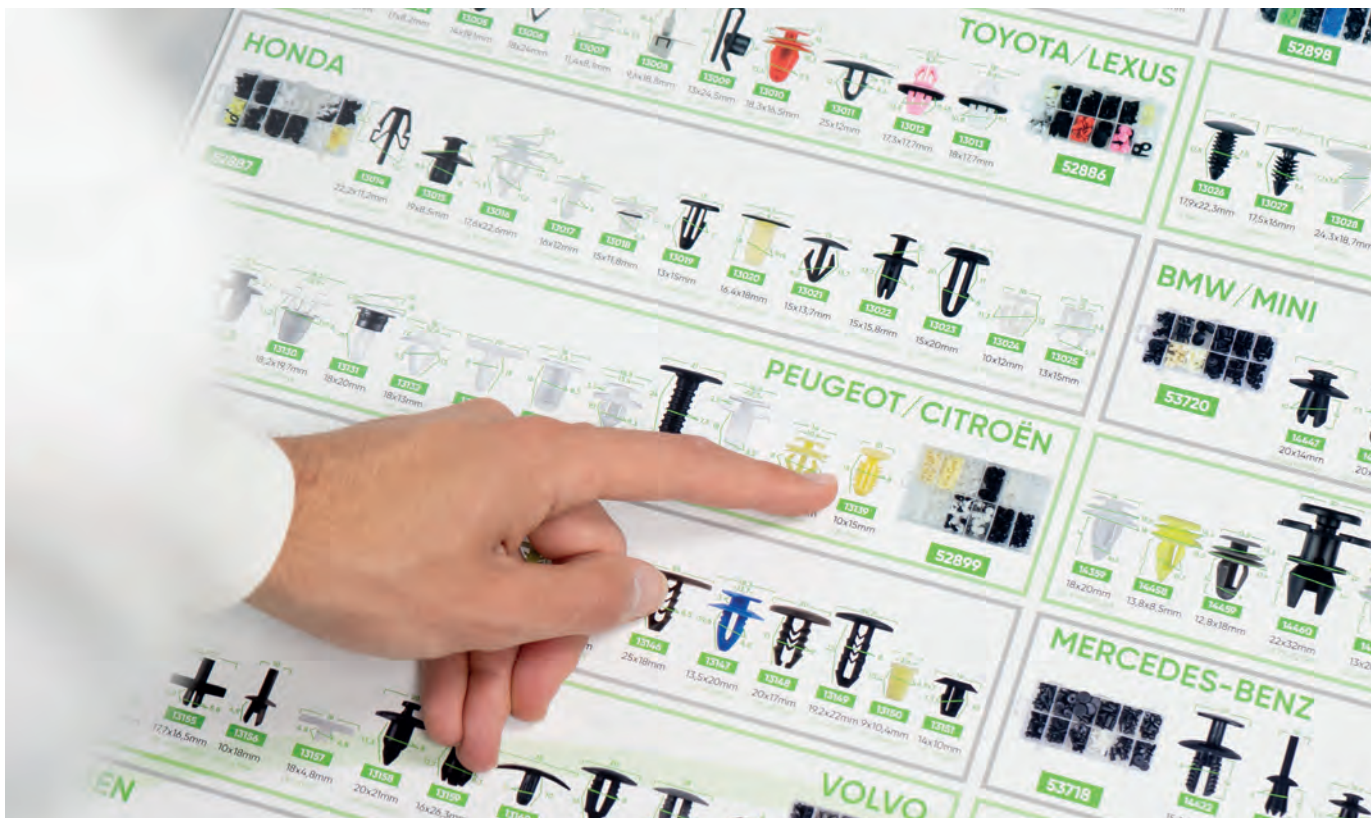

16294 14,00€

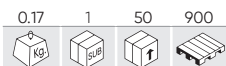

POSTER CLIPS REAL SIZE

TECHNICAL SPECIFICATIONS:

Poster size: 1000x640mm
Material: 250g plasticized paper
It has holes to hang it.

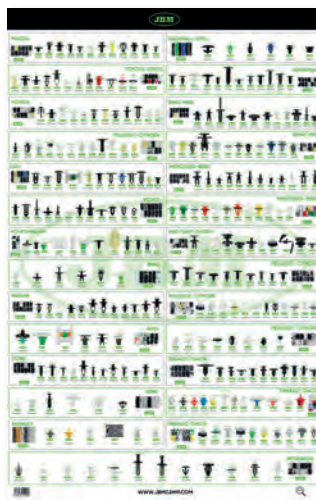

TAMAÑO REAL DE LOS CLIPS
CLIPS REAL SIZE

52851 9,65€ **53110** 27,30€



SET OF 2 LEVERS



6 LEVER SET



- 5"x8.5mm
- 5"x10.3mm
- 5"x4.5mm
- 15"x8.5mm
- 15"x10.3mm
- 15"x4.5mm



CONSUMABLES



UNITS IN THE CASE



UNITS PER SPARE PARTS BAG



PRESENTATION IN A DISPLAY

52896



26,00€



PLASTIC CLIPS SET FOR MAZDA 190 PCS

REF.	DESCRIPTION	Case	Bag	€
13104	OE:2042301	8	8	1,90€
13105	OE:999100402	15	15	2,50€
13106	OE:B0016830200	8	8	2,00€
13107	OE:N30413356A	8	8	2,15€
13108	OE:992640543A	20	20	1,90€
13109	OE:99249051B	30	30	2,90€
13110	OE:6508197AA	15	15	1,85€
13111	OE:B1016825200	10	10	1,20€
13112	OE:B09251833	6	6	1,65€
13113	OE:992640543A	20	20	2,20€
13114	OE:B45556741	20	20	2,20€
13115	OE:G03158762	30	30	2,50€



52886



18,00€



PLASTIC CLIPS SET FOR TOYOTA / LEXUS 89 PCS

REF.	DESCRIPTION	Case	Bag	€
13002	OE:9018906001	8	8	1,45€
13003	OE:9046707138	5	4	1,70€
13004	OE:9046707117	10	10	1,85€
13005	OE:9046709138	10	10	1,25€
13006	OE:9046709101	5	5	1,40€
13007	OE:75521611000	10	10	1,30€
13008	OE:7503933060	8	8	2,25€
13009	OE:9017905060	4	4	1,65€
13010	OE:677711250	8	8	1,75€
13011	OE:9046708124	5	5	1,15€
13012	OE:7539533030	8	8	1,80€
13013	OE:9046711063	8	8	1,75€



52887

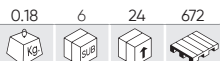

22,00€



PLASTIC CLIPS SET FOR HONDA 150 PCS

REF.	DESCRIPTION	Case	Bag	€
13014	OE:75103SJ4003	12	12	1,45€
13015	OE:90675SB003	5	5	1,20€
13016	OE:91566SP0003	6	6	1,15€
13017	OE:91513SE003	25	25	2,60€
13018	OE:91530ST5003	25	25	1,45€
13019	OE:90687SA50030	15	15	1,75€
13020	OE:91620SR2003	8	8	1,70€
13021	OE:38529689A6300	8	8	1,30€
13022	OE:90683SA5003	10	10	2,10€
13023	OE:90672671003	10	10	1,50€
13024	OE:91534SEO000	18	18	2,45€
13025	OE:34355SD2003	8	8	1,50€



52899

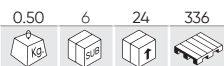

34,00€



PLASTIC CLIPS SET FOR PEUGEOT/CITROEN 345 PCS

REF.	DESCRIPTION	1	2	€
13128	OE:947098	50	50	1,85€
13129	OE:856535	20	20	2,00€
13130	OE:6991W4	20	20	3,75€
13131	-	20	20	3,45€
13132	OE:694143	25	25	2,65€
13133	OE:743707	35	35	3,45€
13134	OE:7703074022	30	30	3,95€
13135	OE:7703077059	35	35	3,45€
13136	OE:698317	15	15	2,60€
13137	OE:699502	25	25	2,25€
13138	OE:6995X3	30	30	2,85€
13139	OE:69945	40	40	3,85€



52900



34,00€



PLASTIC CLIPS SET FOR FIAT 308 PCS

REF.	DESCRIPTION	1	2	€
13140	OE:14591784	30	30	2,65€
13141	OE:1459487	20	10	1,80€
13142	OE:1300433650	25	25	3,10€
13143	OE:71717421	8	8	1,95€
13144	OE:82456515	25	25	2,20€
13145	OE:5757139	25	25	3,85€
13146	-	20	8	4,50€
13147	OE:46306526	25	25	3,10€
13148	OE:14591687	25	25	3,30€
13149	OE:14592387	25	25	3,10€
13150	OE:83468473	30	30	2,25€
13151	OE:7677865	50	30	5,35€

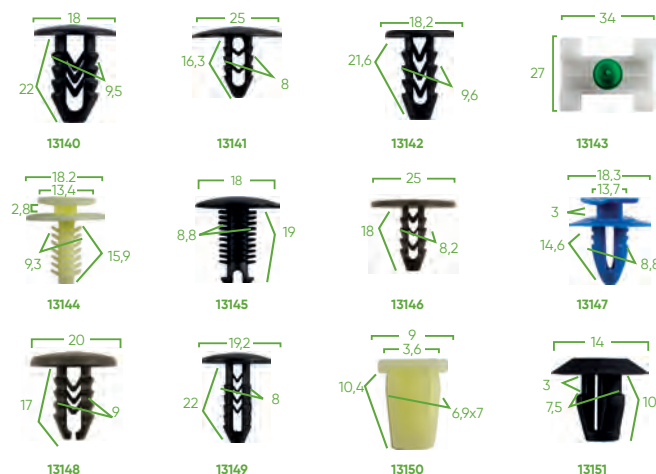

52901

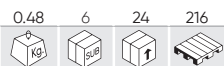

34,00€



PLASTIC CLIPS SET FOR VOLVO 350 PCS

REF.	DESCRIPTION	1	2	€
13152	OE:8099905N07	25	25	3,05€
13153	OE:4292906	30	30	3,10€
13154	OE:12681763	20	20	3,20€
13155	OE:51131804205	40	40	5,60€
13156	OE:947098	40	40	3,30€
13157	OE:591740	40	40	3,85€
13158	OE:6384801G00	25	25	3,75€
13159	OE:9133417	20	20	3,20€
13160	OE:9133073	40	40	5,00€
13161	OE:3272075327462B	30	30	3,55€
13162	OE:327462A	20	20	2,60€
13163	OE:3923712	20	20	2,80€

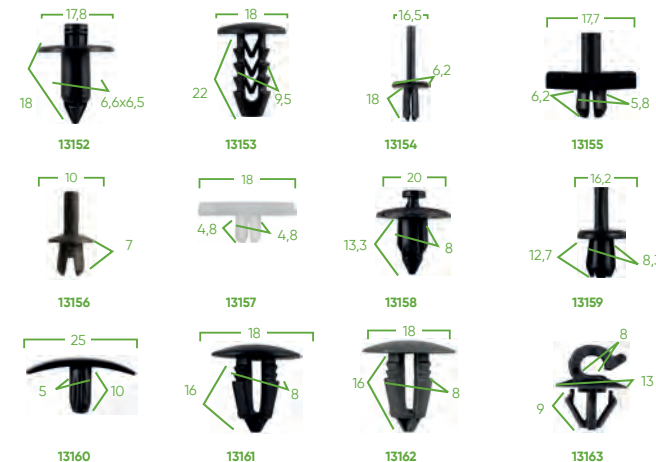

52889

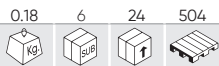

19,00€



PLASTIC CLIPS SET FOR VOLKSWAGEN 85 PCS

REF.	DESCRIPTION	kg	Box	€
13038	OE:1H0868243B	2	2	1,40€
13039	OE:N90833801	10	10	1,65€
13040	OE:3A0853575	8	8	1,80€
13041	OE:4A0853825	5	5	1,55€
13042	OE:6U085733	15	15	1,95€
13043	OE:3B0853576	3	3	1,20€
13044	OE:1H0819055B01C	6	6	1,55€
13045	OE:443853909A	5	5	1,20€
13046	OE:171885767	6	6	1,55€
13047	OE:N9020160H	5	5	1,45€
13048	OE:NO385501	10	10	2,20€
13049	OE:191941142	10	10	2,05€

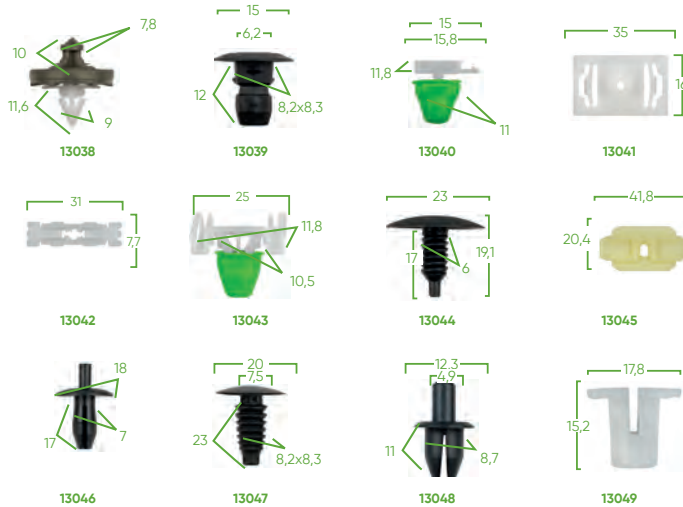

52891

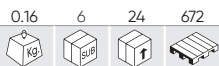

28,00€



PLASTIC CLIPS SET FOR FORD 169 PCS

REF.	DESCRIPTION	kg	Box	€
13056	OE:388577S	8	8	1,55€
13057	OE:N801925S	5	5	1,50€
13058	OE:N806289S	20	20	2,20€
13059	OE:N379830S	20	20	2,35€
13060	OE:1007932	5	5	1,60€
13061	OE:16500308	20	20	2,65€
13062	OE:N803170S	20	20	2,35€
13063	OE:W706713S300	6	6	1,15€
13064	OE:N388246S	20	20	2,60€
13065	OE:F22Z16774A	15	15	2,00€
13066	OE:1673046	5	5	2,25€
13067	OE:F1CZ16674A	25	25	2,55€

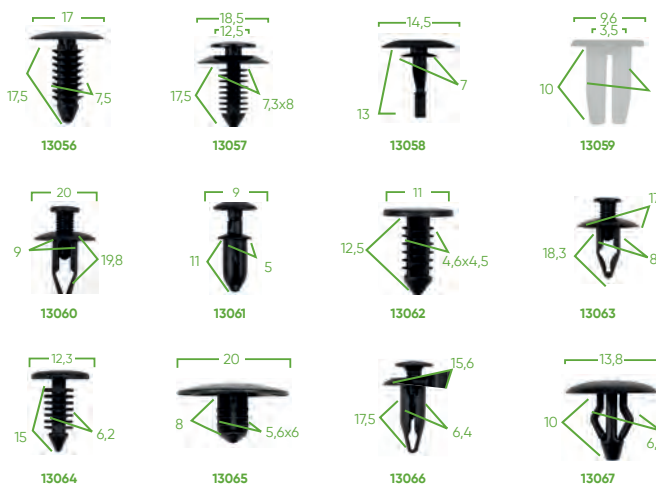

52894

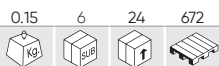

22,00€



PLASTIC CLIPS SET FOR NISSAN 139 PCS

REF.	DESCRIPTION	kg	Box	€
13080	OE:76906T300	15	15	1,75€
13081	OE:0155300172	20	20	2,30€
13082	OE:68425H5000	10	10	1,35€
13083	OE:75521611000	6	6	1,50€
13084	OE:62869N4700	20	20	2,10€
13085	OE:6384401A00	5	5	1,60€
13086	OE:7688257A00	5	5	1,25€
13087	OE:6684101G00	25	25	3,30€
13088	OE:1099830880	10	10	2,40€
13089	OE:8942798070	10	10	1,70€
13090	OE:6384801G00	8	8	1,70€
13091	OE:6385401A00	5	5	1,25€



52890



22,00€



PLASTIC CLIPS SET FOR AUDI 31 PCS

REF.	DESCRIPTION		€
13050	OE:3B0868243	5 15	1,55€
13051	OE:1H0867199A	5 20	1,50€
13052	OE:1H0868243B	3 3	1,25€
13053	OE:357853575	10 10	2,80€
13054	OE:1H0853585A	5 5	2,35€
13055	OE:3A0853575	3 3	3,00€

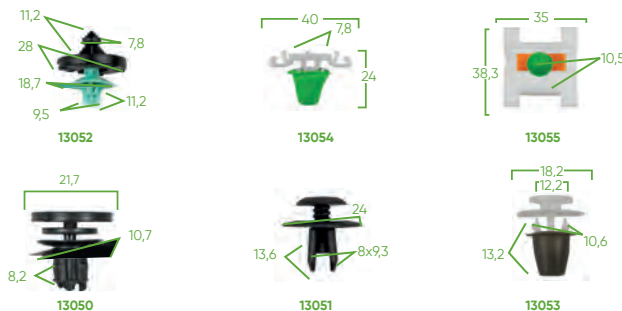

52892

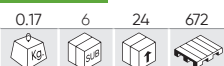

22,00€



PLASTIC CLIPS SET FOR BMW 95 PCS

REF.	DESCRIPTION		€
13068	OE:51311802258	25 25	2,85€
13069	OE:5131804205	30 30	4,55€
13070	OE:51118174185	10 10	2,15€
13071	OE:51481938725	10 10	2,05€
13072	OE:703867299	15 15	2,75€
13073	OE:51131960054	5 5	2,10€

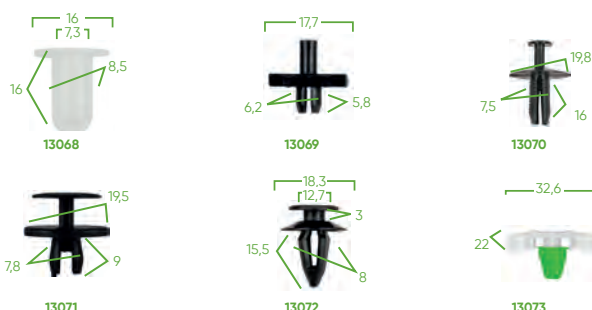

52897

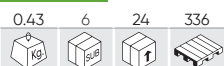

38,00€



PLASTIC CLIPS SET FOR RENAULT 300 PCS

REF.	DESCRIPTION		€
13116	OE:7703077421	50 50	5,45€
13117	-	50 50	3,65€
13118	OE:7703081184	60 60	15,90€
13119	-	15 15	5,60€
13120	OE:7703074022	60 60	5,50€
13121	OE:7703077059	65 65	8,75€

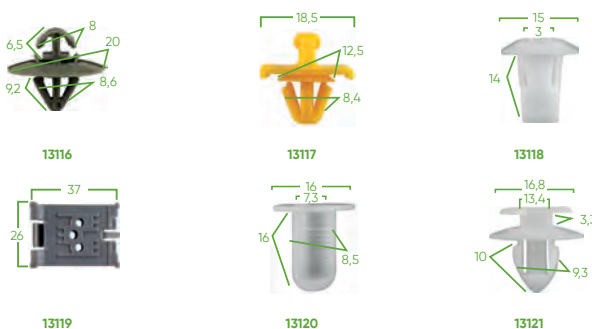

52898

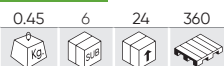

36,00€



PLASTIC CLIPS SET FOR VAUXHALL/OPEL 300 PCS

REF.	DESCRIPTION		€
13122	OE:90218614	20 20	1,95€
13123	OE:174864	40 40	5,35€
13124	OE:N0385501	100 100	8,20€
13125	OE:2345959	50 50	5,95€
13126	OE:2240582	50 50	1,55€
13127	OE:180942	40 40	5,60€

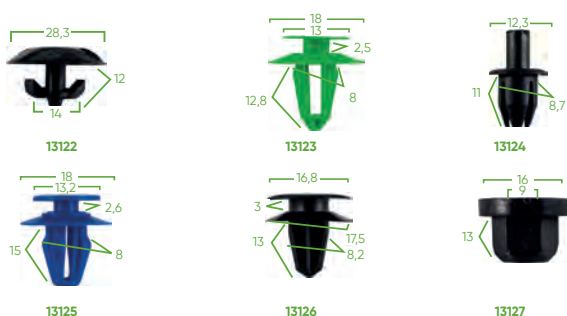

52893

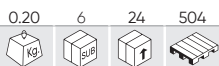

26,00€



PLASTIC CLIPS SET FOR BENZ 95 PCS

REF.	DESCRIPTION	kg	units	€
13074	OE:A0019884481	30	30	4,65€
13075	OE:A0019882981	20	20	5,35€
13076	OE:A1249900492	15	15	3,90€
13077	OE:A0019888081	4	4	2,55€
13078	OE:A1249880492	6	6	2,55€
13079	OE:A0019880325	20	20	3,35€

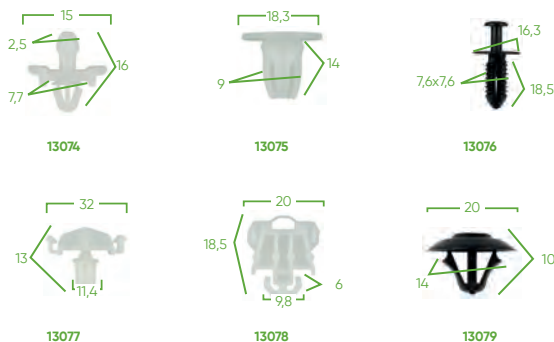

52895



22,00€



PLASTIC CLIPS SET FOR MITSUBISHI 134 PCS

REF.	DESCRIPTION	kg	units	€
13092	OE:8942180270	15	50	1,65€
13093	OE:9018905013	30	30	2,95€
13094	OE:MU480033	10	10	1,50€
13095	OE:128100231	8	6	1,20€
13096	OE:MU480034	8	8	1,70€
13097	OE:MR138807	3	3	1,20€
13098	OE:MB253964	4	4	1,65€
13099	OE:HB121467	30	30	2,75€
13100	OE:MB271999	3	3	1,20€
13101	OE:MB696120	8	8	1,50€
13102	OE:MR200300	5	5	1,60€
13103	OE:MB846992	10	10	1,80€

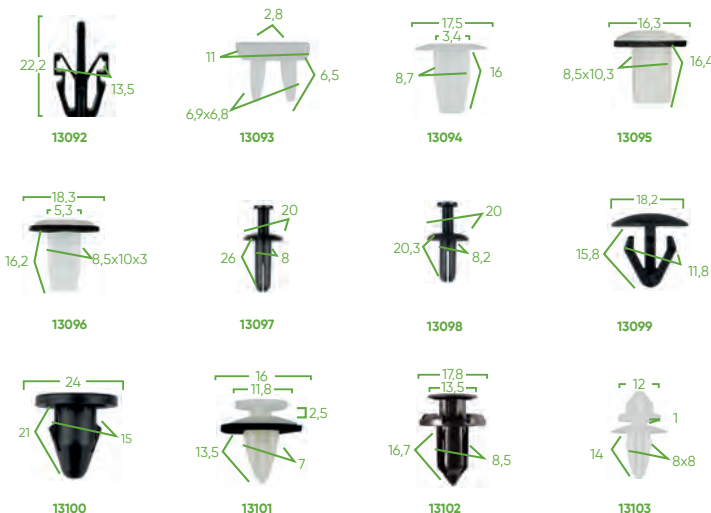

52888



24,00€



UNIVERSAL PLASTIC CLIPS SET 128 PCS

REF.	DESCRIPTION	kg	units	€
13026	OE:388577S	8	8	1,55€
13027	-	10	10	1,85€
13028	OE:6003423	6	6	1,45€
13029	OE:VW:N989022 CHRYSLER: 6003349 FORD:385661	6	6	1,65€
13030	OE:CHRYSLER: 6502328 GM:20699808	25	25	2,80€
13031	OE:N804379S	4	4	1,85€
13032	OE:FORD:F22Z16774A MAZDA:6508197AA	15	15	2,00€
13033	OE:GM:16674629 FORD:N806113S	10	10	1,60€
13034	OE:0153301781	20	20	2,65€
13035	OE:GM:10124502 BMW:52201964201 LAND ROVER:- DZM10080	6	6	1,65€
13036	OE:VW:N9020160H BMW:51471904317 OPEL:2207713	6	6	1,40€
13037	-	12	12	2,10€

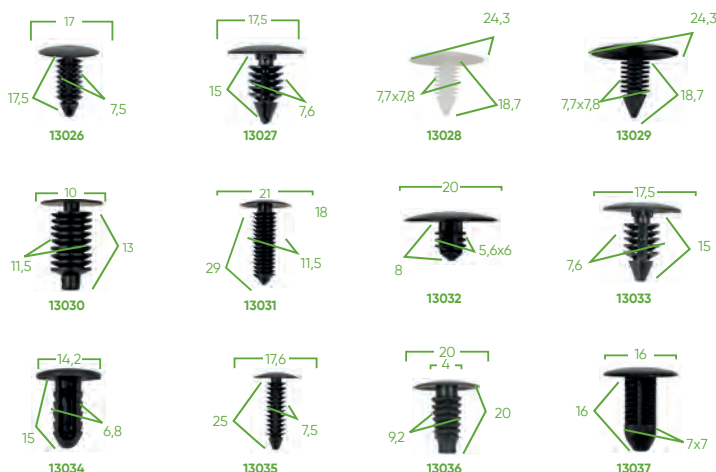

53720

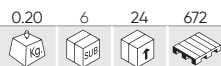

19,00€



112 PCS CLIP ASSORTMENT BMW MINI FOR UPHOLSTERY

REF.	DESCRIPTION	1	2	€
14447	OE: 51471911992	7	6	1,45€
14449	OE: 51717002953	13	10	2,20€
14471	OE: 51489119216	5	5	1,90€
14472	OE: A0009905492	5	5	1,35€
14474	OE: 51118174185	8	8	1,50€
14475	OE: 2019900050	6	6	1,65€
14476	OE: 51481915964	9	9	2,05€
14477	OE: 0009881625	15	15	2,45€
14478	OE: 7146976114	15	15	4,05€
14479	OE: 91503SP0003	6	6	1,65€
14480	-	15	15	2,05€
14481	OE: 51161943122	8	8	1,70€



53719



19,00€



92 PCS CLIP ASSORTMENT BMW MINI FOR DOOR PANEL/MOLDING

REF.	DESCRIPTION	1	2	€
14359	-	8	8	1,05€
14458	-	6	6	1,70€
14459	OE: 7147122912	2	2	1,45€
14460	OE: 51411973500	8	8	1,15€
14461	-	8	8	1,35€
14462	-	8	8	1,65€
14463	OE: 611769	10	10	1,65€
14464	OE: 7147145753	10	10	1,50€
14465	-	8	8	2,00€
14466	OE: 51418224768	8	4	1,65€
14468	-	8	8	1,30€
14469	OE: 7147133419	8	8	1,45€

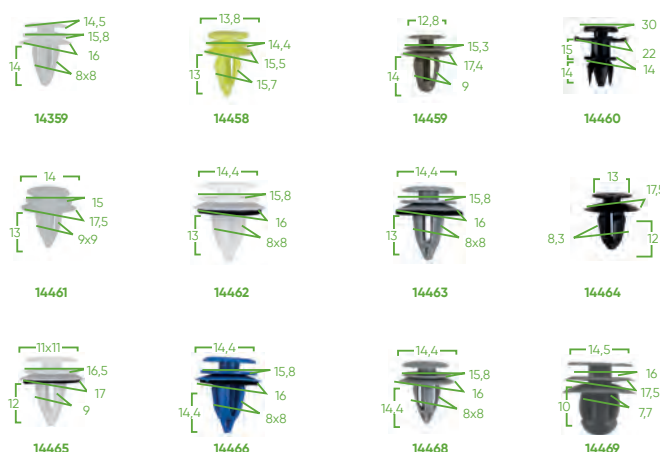

53718

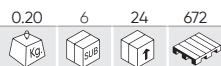

19,00€



151 PCS CLIP ASSORTMENT MERCEDES-BENZ FOR UPHOLSTERY

REF.	DESCRIPTION	1	2	€
14422	OE: A0009913940	20	20	1,50€
14446	OE: 9903492	6	6	2,80€
14447	OE: 51471911992	12	12	1,45€
14448	OE: N105835019B9	10	10	2,05€
14449	OE: A0009905492	12	12	2,20€
14450	OE: N0385012	12	12	2,15€
14451	OE: A1239900092	25	25	2,15€
14452	-	20	20	2,55€
14453	-	6	6	3,05€
14455	-	12	12	2,10€
14456	-	6	6	1,35€
14457	OE: A1249900492	10	10	1,70€

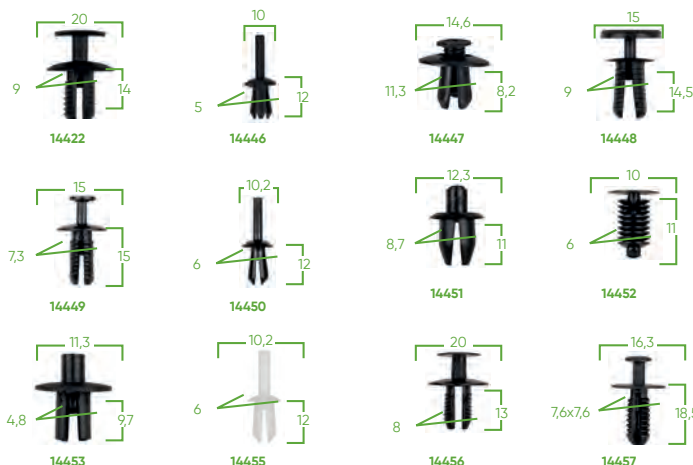

53717

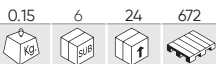

19,00€



96 PCS CLIP ASSORTMENT MERCEDES-BENZ FOR DOOR PANEL/MOLDING

REF.	DESCRIPTION	kg	unit	€
14434	-	8	8	1,60€
14435	-	6	6	1,45€
14436	OE: A0009910198	8	8	1,70€
14437	OE: A0019912698	6	6	1,45€
14438	OE: A0089880978	8	8	1,35€
14439	OE: 0069884378	8	8	1,75€
14440	-	8	8	1,75€
14441	OE: 0019884981	10	10	1,65€
14442	-	6	6	1,45€
14443	-	8	8	1,45€
14444	OE: 0019886081	10	10	1,90€
14445	-	10	10	1,45€

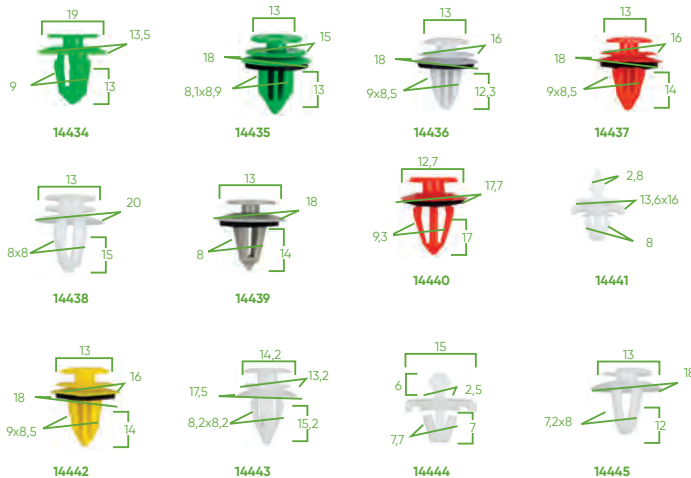

53716

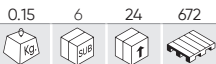

19,00€



79 PCS CLIP ASSORTMENT VAG/SEAT/SKODA FOR DOOR PANEL/MOLDING/ UPHOLSTERY

REF.	DESCRIPTION	kg	unit	€
14422	OE: A0009913940	6	6	1,50€
14423	OE: 6E0837732	15	15	3,55€
14424	-	7	7	1,85€
14425	OE: 6Q0868243	2	2	2,05€
14426	OE: 171201969	8	8	1,90€
14427	OE: 4D0807300	8	4	1,20€
14428	OE: 251823717	12	12	1,40€
14429	-	6	6	1,80€
14430	OE: 8E0821989A	3	3	2,25€
14431	OE: 3B0868243	2	2	1,45€
14432	OE: 1H0823171	10	10	1,45€

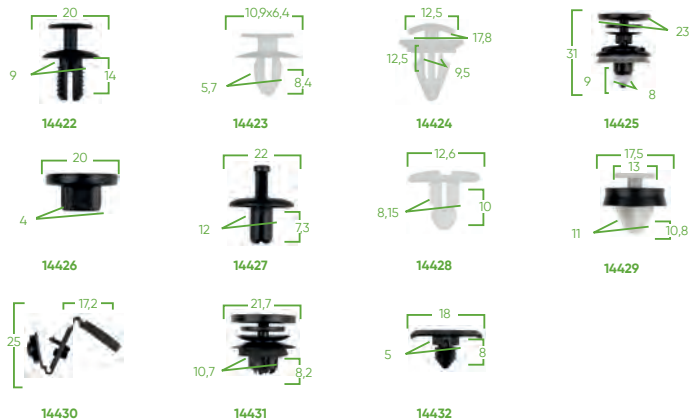

53715

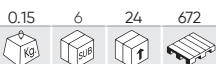

19,00€



110 PCS CLIP ASSORTMENT PEUGEOT/CITROËN FOR UPHOLSTERY

REF.	DESCRIPTION	kg	unit	€
14410	-	10	10	1,85€
14411	-	10	5	1,70€
14412	-	10	10	1,70€
14413	-	10	10	3,25€
14414	OE: 2346824	10	10	1,70€
14415	OE: A1249900492	10	10	1,70€
14416	OE: 6992C6	10	5	1,25€
14419	-	15	15	1,95€
14420	-	15	15	1,50€
14421	OE: 14093311	10	10	2,45€

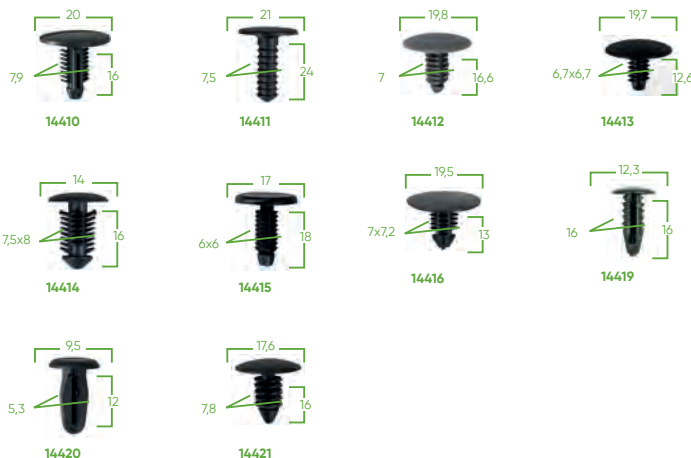

53714

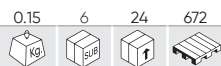

16,00€



80 PCS CLIP ASSORTMENT PEUGEOT/CITROËN FOR MOLDING

REF.	DESCRIPTION	Calculator Icon	Weight Icon	€
14398	OE: 6995X3	8	8	1,30€
14399	OE: 129943	12	6	1,90€
14402	OE: 856548	8	8	1,50€
14404	OE: 71728806	8	8	2,10€
14405	OE: 968865987703	16	8	1,45€
14406	OE: 856540	10	10	1,55€
14408	OE: 856534	10	10	1,45€
14409	OE: 357853586	8	8	1,35€

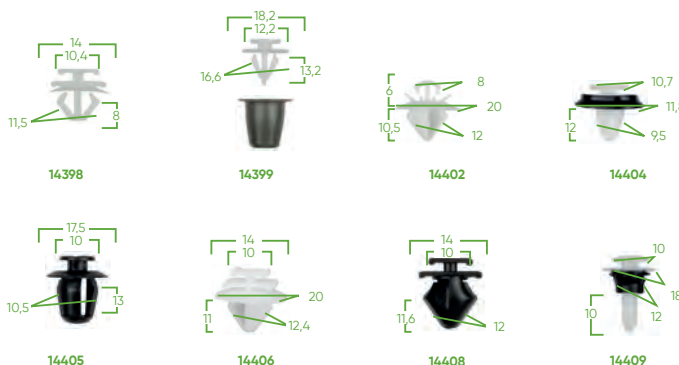

53713

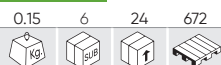

16,00€



93 PCS CLIP ASSORTMENT PEUGEOT/CITROËN FOR DOOR PANEL

REF.	DESCRIPTION	Calculator Icon	Weight Icon	€
14350	OE: 6991Y8	6	6	1,80€
14358	OE: PG 6991Y8 CT 6991Y8 FIAT 9654280780 RENAULT 703077469	10	10	1,70€
14387	-	8	8	1,45€
14388	OE: 7703077250	8	8	2,05€
14389	OE: 6995A3	6	6	1,25€
14390	-	6	6	1,35€
14391	-	15	15	2,15€
14392	-	6	6	1,35€
14393	-	8	8	1,50€
14395	-	8	8	1,65€
14396	-	6	6	1,20€
14397	-	6	6	1,45€

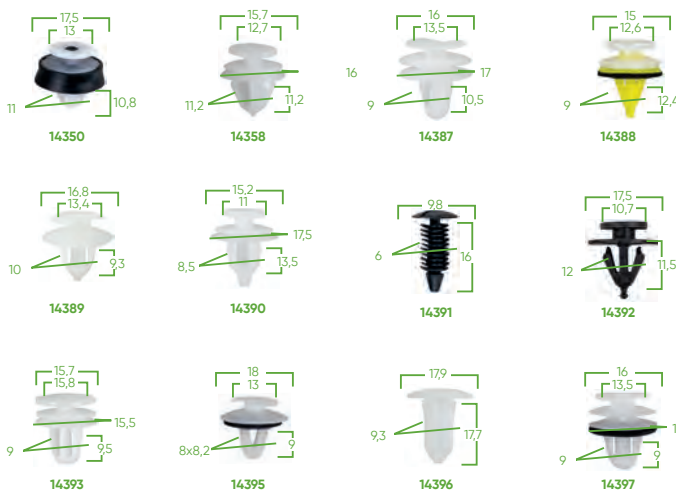

53712

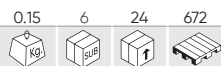

16,00€



109 PCS CLIP ASSORTMENT RENAULT DACIA FOR UPHOLSTERY

REF.	DESCRIPTION	Calculator Icon	Weight Icon	€
14374	OE: 7703077435	3	3	1,70€
14375	-	15	15	1,85€
14376	OE: 7L6868307	20	20	2,60€
14377	-	10	10	1,90€
14378	OE: 7703077117	12	12	1,90€
14379	-	6	6	1,45€
14381	-	10	10	1,70€
14382	OE: 7703077153	6	6	1,85€
14383	OE: 7703072360	10	10	1,35€
14384	OE: W705956S300	12	12	2,10€
14416	OE: 6992C6	5	5	1,25€



53711

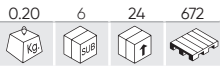

16,00€



90 PCS CLIP ASSORTMENT RENAULT DACIA FOR MOLDING

REF.	DESCRIPTION	10	10	€
14356	OE: RENAULT 7703077368 OPEL 4430858	10	10	1,90€
14358	OE: PG 6991Y8 CT 6991Y8 FIAT 9654280780 RENAULT 703077469	12	10	1,70€
14364	OE: OP 7701470779 NI 7703077421 RENAULT 7703077421 IV 500326896	10	10	1,90€
14365	OE: OP 7701470779 NI 7703077421 RENAULT 7703077421 IV 500326896	10	10	1,90€
14366	OE: PG 6991Y8 CT 6991Y8 FIAT 9654280780 RENAULT 703077469	8	8	1,45€
14367	-	3	3	1,30€
14368	OE: 7L5853994	8	8	1,45€
14369	OE: 7701061797	15	15	4,95€
14370	-	3	3	3,00€
14371	-	3	3	3,00€
14372	-	4	4	1,20€
14373	-	4	4	1,35€



53710

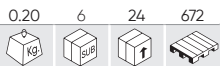

16,00€



85 PCS CLIP ASSORTMENT RENAULT DACIA FOR DOOR PANEL

REF.	DESCRIPTION	12	6	€
14350	OE: 6991Y8	12	6	1,80€
14351	-	8	15	1,65€
14352	OE: 51447780135	7	7	1,30€
14353	OE: 7703077476	8	2	2,10€
14355	OE: 7703077354	8	8	1,70€
14356	OE: RENAULT 703077368 OPEL 4430858	10	4	1,90€
14357	OE: 7703077430	10	12	1,90€
14358	OE: PG 6991Y8 CT 6991Y8 FIAT 9654280780 RENAULT 703077469	10	6	1,70€
14359	OE: 51418224768	4	3	1,05€
14361	-	8	15	1,70€

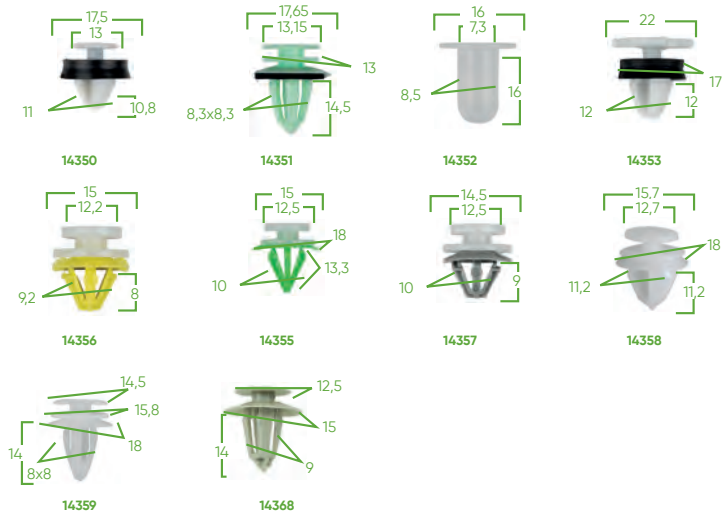

WORK CLOTHING

406 VEST

406 JACKETS

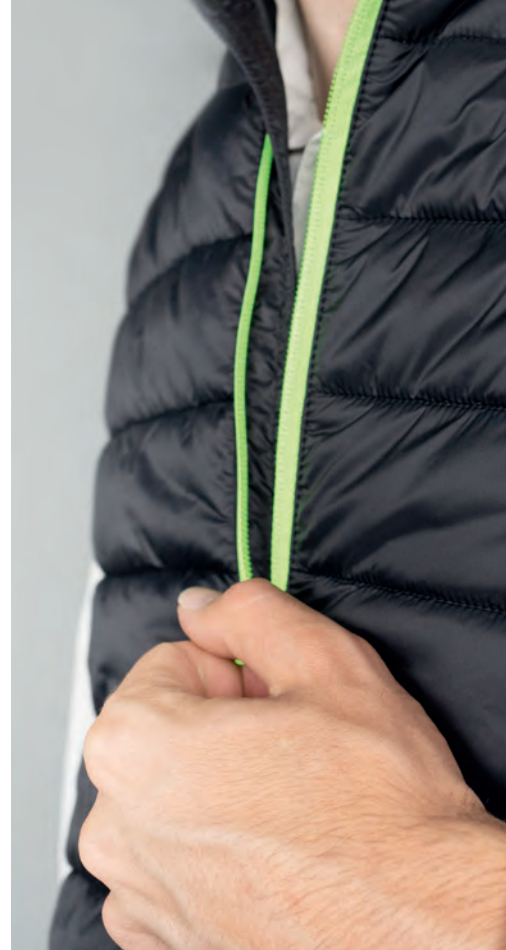



JBM VEST



70001
70002
70003



70013
70014
70015
70016
70017



70009

REF.		■	■	■	📦	📦	📦	🚚	€
70001	M	●			0.30	-	5	200	35,00€
70002	L	●			0.40	-	5	200	35,00€
70003	XL	●			0.40	-	5	200	35,00€
70009	XL		●		0.40	-	5	180	35,00€
70013	S		●		0.30	-	10	240	44,00€
70014	M		●		0.30	-	10	240	44,00€
70015	L		●		0.30	-	10	240	44,00€
70016	XL		●		0.35	-	10	240	44,00€
70017	XXL		●		0.35	-	10	200	44,00€

JBM JACKET

70004
70005
70006



70011
70012

REF.		■	■	■	📦	📦	📦	🚚	€
70004	M	●			0.60	-	5	140	42,00€
70005	L	●			0.70	-	5	140	42,00€
70006	XL	●			0.70	-	5	140	42,00€
70011	L		●		0.60	-	5	120	42,00€
70012	XL		●		0.70	-	5	120	42,00€

13929

3,45€



CLOTHES HANGER 49CM



METEXP

62,00€



HANGING RAIL



PROMOTIONAL

408 PROMOTIONAL PRODUCTS

410 DISPLAYS / ACCESSORIES

412 PACKAGING



PROMOTIONAL

53956

353,00€

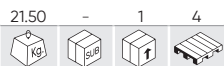

GAMING CHAIR

SIZE: 70x55x126-136cm

ADJUSTABLE HEIGHT

LUMBAR CUSHION

HEADREST CUSHION



Material: Polyurethane
 Iron frame thickness: 1,2cm
 Seating oam: Moulded foam
 Back foam: Primary Foam
 Armrest: 2D
 Gas lift: Class 3
 Nylon base: 350mm



SPARE PARTS AVAILABLE

54043

48,00€



JBM BACKPACK

Storage space and pockets:
 With a total of two compartments,
 it can hold laptops under 17.3 inches
 and tablets, among others.

Material: Polyurethane, it is a
 waterproof, solid and durable
 backpack.

Lightweight and comfortable:
 Comfortable and breathable sponge
 mesh design of the back and straps.



53973

284,00€



JBM FOLDING STAND TENT 3X3M

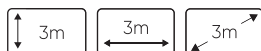

REF.	DESCRIPTION	Icon 1	Icon 2	Icon 3	Icon 4	€
14347	OUTER BAG FOR JBM DISPLAY	0.60	-	5	-	36,50€

15152

160,00€



SIDE COVER FOR JBM DISPLAY REF. 53973

It consists of two parts:
 - Side part that covers 3/4 parts of the tent.
 - Front part that covers 1/4 part of the tent. With vertical zipper as a door.



54325 22,50€

2.30 - 10 120

Kg SUB f

N

FLOOR MAT 100X65CM



54278 4,50€

0.10 5 200 1800

Kg SUB f

N

JBM CAP



54480 1,00€

0.00 500 2000 40000

Kg SUB f

N

JBM KEY-CHAIN



53949 4,50€

0.10 - 15 540

Kg SUB f

BLACK JBM COOLER BAG



53950 4,50€

0.10 - 15 630

Kg SUB f

GREEN JBM COOLER BAG



13968 1,35€

0.01 50 200 2400

Kg SUB f

JBM PROMOTIONAL BAG



53533 1,50€

0.01 50 1000 12000

Kg SUB f

JBM PROMOTIONAL 4 COLORS PEN



54076 9,00€

0.50 - 50 700

Kg SUB f

JBM MUG



340ml



PROMOTIONAL

53504

38,00€

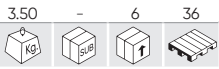

SCOOTER



14975

64,00€



HAM HOLDER



HOOKS

REF. FOR	kg	boxes	units	units	€
14034 PNEUMATIC TOOLS	0.20	20	80	1920	9,00€
14623 REF. 60046, 60044, 60048, 60005, 60006	0.10	-	10	800	8,00€
14626 REF. 60023	0.10	-	10	-	7,00€
11318 HOOK WITH ONE TIP	0.04	20	600	-	2,50€
16364 HOOK WITH ONE LONG TIP 280MM	0.20	-	200	-	3,50€
51315 HOOK WITH CLOSED TIP	0.02	20	320	44800	2,50€

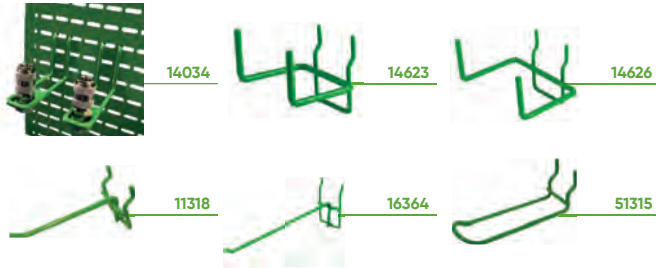

TRAY

REF. FOR	kg	boxes	units	units	€
14622 REF. 60001, 60003, 60004, 60020	0.95	-	10	360	17,00€
14624 REF. 60007, 60010, 60011	0.65	-	10	300	17,00€
14625 REF. 60028, 60009	0.50	-	10	700	14,00€



53492

380,00€

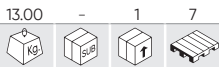

AIR TOOL DISPLAY STAND



TOOLS NOT INCLUDED



METEXP

62,00€

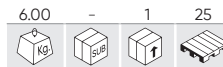

HANGING RAIL



REF. DESCRIPTION	kg	boxes	units	units	€
13929 CLOTHES HANGER 49CM	0.10	-	-	280	3,45€



53877 430,50€

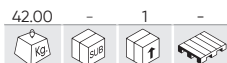

TOOL DISPLAY

53878 574,00€



TOOL DISPLAY + HEAD + LIGHTS

53879 838,50€



TOOL DISPLAY CABINET + LIGHTS + LOCKABLE



IT CONTAINS

14945	x1
14346	x1
14380	x1
11318	x20

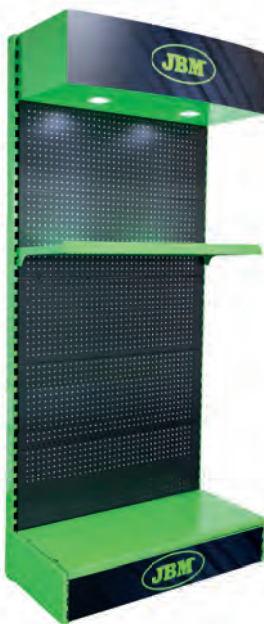

IT CONTAINS

14945	x1
14947	x1
14380	x1
11318	x20



IT CONTAINS

14945	x1
14947	x1
14948	x1
14996	x1
11318	x20



SPARE PARTS FOR TOOLS DISPLAY

REF.	DESCRIPTION	kg	mm	mm	mm	€
14945	TOOLS DISPLAY - BASE	37.80	-	1	15	303,50€
14946	HEADER FOR TOOLS DISPLAY STAND	3.40	-	1	51	58,00€
14947	LIGHT HEADER FOR TOOLS DISPLAY	8.55	-	1	6	201,50€
14948	SET OF 2 DOORS FOR TOOLS DISPLAY	31.10	-	1	40	251,50€
14380	TRAY FOR TOOLS DISPLAY 53877	5.00	-	1	34	51,00€
14996	TRAY FOR TOOLS DISPLAY WITH DOOR	5.00	-	1	33	65,00€



PROMOTIONAL

53914

75,00€

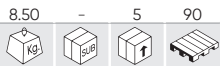

POST WITH RETRACTABLE TAPE

- Material: Steel
- Tube diameter: 63mm
- Base diameter: 320mm
- Height: 910mm
- 4-way tape output
- Tape length: 3m
- Tape width: 48mm



14807

11,00€

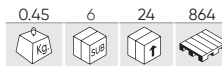

JBM WARRANTY SEAL



ALL LANGUAGES IN THE SAME SEAL

- 75mm wide x 125m long
- Made of polypropylene
- Solvent adhesive
- Thickness: 28 micron

CARDBOARD BOX JBM

BOX FOR SPARE HAND-TOOLS

REF. DESCRIPTION				€
14922 BOX FOR SPARE PARTS 14,5X9X10CM	0.10	100	-	0,84€
14923 BOX FOR SPARE HAND-TOOLS 17,5X9X7CM	0.10	100	-	0,84€
14924 BOX FOR SPARE PARTS 24X11X7CM	0.10	100	-	0,84€
14925 BOX FOR SPARE PARTS 31,5X13X4CM	0.10	100	-	0,84€
14926 BOX FOR SPARE PARTS 32X8,5X7CM	0.10	100	-	1,05€



PROMOTIONAL BOXES

REF. DESCRIPTION				€
13717 JBM HAM BOX 76X14X29CM	0.90	1	200	7,65€
14083 GREEN CARDBOARD BOX PROMO 80X28X49CM	1.80	1	100	13,20€
14976 CARTON BOX PROMOTIONAL LOT 80X31X61CM	2.20	1	80	18,84€
15056 CARTON BOX PROMO 40X30X61CM	1.60	1	70	11,70€



JBM BOX

REF. DESCRIPTION				€
11330 JBM SMALL CARDBOARD BOX 19X10X11CM (JOINT BOOT KIT)	0.05	50	4200	0,57€
12950 JBM CARDBOARD BOX 60X40X30CM	0.80	15	75	3,45€
12952 JBM CARDBOARD BOX 40X30X20CM	0.40	20	240	1,92€
13217 JBM CARDBOARD BOX 57X30X25CM (EMERGENCY KITS)	0.55	15	150	1,31€
14974 JBM CARDBOARD BOX 54X24X40CM (20 JOINT BOOT KITS)	0.65	20	240	2,28€
15051 JBM CARTON BOX 40X32X30CM	0.40	20	160	1,92€
14189 PALLET BOX AMERICANO TRIPLE CANAL	10.00	1	40	52,00€
14507 PALLET BOX EUROPEO	8.00	1	40	50,00€



















LEGEND











LOGISTICS

 WEIGHT IN KILOGRAMS	 QUANTITY FOR INNER-BOX	 QUANTITY PER BOX	 QUANTITY PER PALLET
 QUANTITY PER BAG	 QUANTITY PER SET	 PRESENTATION IN DISPLAY	

GENERAL

 NUMBERS OF PARTS	 PRESENTATION IN BLISTER	 MAGNETIC	 TACTILE
 BATTERY CHARGING CAPACITY	 CHARGING DURATION	 ERGONOMIC HANDLE	 CANNOT BE WASHED
 PROTECT FROM RAIN AND HUMIDITY	 RECYCLABLE PRODUCT	 INFORMATION	 WIRELESS
 ELECTRIC CAR	 HIGH VOLTAGE SIGNS	 EURO EUROPEAN REGULATION	 US AMERICAN REGULATION
 UNIVERSAL UNIVERSAL REGULATION			



















MEASUREMENT UNITS

 LENGTH	 MASS	 DIAMETER	 OTHERS
 CAPACITY	 INCHES	 MAXIMUM - MINIMUM	 DEGREES
 AREA	 CELSIUS DEGREES	 SOUND	

MEASUREMENT UNITS FOR SPECIFIC ITEMS

 DISC DIAMETER	 DISC HOLE DIAMETER IN "	 TUBE DIAMETER	 INNER AND OUTER TUBE DIAMETER
 HOSE LENGTH	 PLUG LENGTH		

MATERIAL

 WOOD	 STEEL	 S2 STEEL	 ALUMINIUM
 COPPER	 CHROMED	 CHROME VANADIUM	 CHROME MOLYBDENUM
 NEODYMIUM	 ZINC	 VINYL POLYCHLORIDE	 POLYPROPYLENE
 POLYETHYLENE	 HIGH DENSITY POLYETHYLENE	 STEEL LAMINATED	 BRASS
 LATEX	 NYLON	 HYDROGENATED NITRILE-BUTADIENE RUBBER	





















YOU CAN ALSO FIND

 BRICKLAYING	 WOOD	 STEEL
--	--	---











TECHNICAL SPECIFICATIONS

HAND TOOLS





BITS

 SLOTTED BITS	 PHILIPS BITS	 POZIDRIV BITS	 TORQ BITS
 RIBE BITS	 FOUR-TIP BIT	 THREE-TIP BIT	 ALLEN BIT
 TORX BIT	 12-POINTS BIT	 SQUARE BIT	 FIVE POINTS TORX BIT
 SPLINE POINT	 BUTTERFLY BIT	 TAMPER-PROOF ALLEN BIT	 TAMPER-PROOF TORX BIT
 12-POINTS TAMPER-PROOF BIT	 TAMPER-PROOF SQUARE BIT	 TAMPER-PROOF FIVE POINTS TORX BIT	 INVOLUBLE SPLINE POINT
 TENSOR BIT			

SOCKETS

 HEXAGONAL SOCKET	 TORX SOCKET	 12-POINTS SOCKET	 SQUARE SOCKET
 5 POINTS SOCKET	 SPLINE SOCKET	 TAMPER-PROOF HEXAGONAL SOCKET	 TAMPER-PROOF TORX SOCKET
 TAMPER-PROOF 12-POINTS SOCKET	 TAMPER-PROOF SQUARE SOCKET	 TAMPER-PROOF FIVE-POINTS SOCKET	 TAMPER-PROOF SPLINE SOCKET











KEYS

 HEXAGONAL SPANNER	 TORX WRENCHES	 KEY TWELVE EDGES	 SQUARE KEY
 FIVE-POINT SPANNER			

















RATCHET

 24 TEETH	 72 TEETH	 90 TEETH
--	--	--

ELECTRIC TOOLS

 10W WATS	 10V VATIUMS	 10 HZ HERTZ	 10 kW KILOWATIUM
 10A AMPERES	 ALTERNATE CURRENT	 DIRECT CURRENT	 ELECTRICAL RESISTANCE
 LI-ION LITHIUM-ION BATTERY	 MICROUSB USB	 LIGHTER PLUG	

PNEUMATIC TOOLS

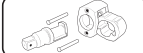
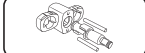
 10 PSI POUNDS FOR SQUARE INCH (PRESSURE)	 10 BAR PRESSURE UNIT	 10 CFM CUBIC FEET PER MINUTE (FLOW)	 10 HP HORSEPOWER (POWER)
 10 RPM GENERAL REVOLUTIONS PER MINUTE	 REVERSE REVOLUTIONS PER MINUTE	 FORWARD REVOLUTIONS PER MINUTE	 MAX 10 Nm MAXIMUM NEWTON PER METER
 10 Nm NEWTON PER METER	 10 BPM PULSES PER MINUTE	 10 KPA KILOPASCAL	 10 MPA MEGAPASCAL
 HVLP HIGH AIR VOLUME AND LOW PRESSURE	 BACK EXIT	 CONNECTABLE TO HOSE	 1/4" AIR ENTRANCE
 x3 SPEED CAPACITY	 JUMBO HAMMER SYSTEM	 DOUBLE HAMMER MECHANISM	

NUMBER INDEX

REF.	PAGE	PRICE
10000	305	7,00 €
10054	232	2,90 €
10055	232	3,90 €
10264	53	2,00 €
10485	231	8,10 €
10486	231	8,00 €
10494	231	6,50 €
10495	231	3,00 €
10496	231	3,00 €
10497	231	3,00 €
10498	231	3,00 €
10499	231	3,00 €
10500	231	3,00 €
10501	231	8,10 €
10502	231	3,50 €
10526	57	10,00 €
10531	41	3,00 €
10532	41	2,70 €
10533	41	3,00 €
10534	41	3,25 €
10535	41	3,50 €
10536	41	3,65 €
10537	41	3,90 €
10538	41	4,30 €
10539	41	4,75 €
10540	41	5,25 €
10541	41	5,55 €
10542	41	5,85 €
10543	41	7,00 €
10544	41	8,10 €
10545	41	9,75 €
10546	41	11,60 €
10547	41	13,50 €
10548	41	1,75 €
10549	41	2,00 €
10550	41	2,15 €
10551	41	2,15 €
10552	38	7,10 €
10553	38	7,35 €
10554	38	7,50 €
10555	38	7,80 €
10556	38	8,10 €
10557	38	8,10 €
10558	38	9,35 €
10559	38	9,50 €
10560	38	10,60 €
10561	38	11,00 €
10562	38	12,30 €
10563	38	12,50 €
10564	42	2,50 €
10565	42	3,50 €
10566	42	3,50 €
10567	42	3,50 €

REF.	PAGE	PRICE
10568	42	4,00 €
10569	42	4,50 €
10570	42	4,50 €
10571	42	5,00 €
10579	42	3,00 €
10580	42	3,10 €
10581	42	3,40 €
10582	42	4,00 €
10583	42	4,15 €
10584	42	5,05 €
10585	42	6,75 €
10586	42	7,60 €
10587	42	9,80 €
10588	42	10,50 €
10589	42	2,00 €
10590	42	2,40 €
10591	44	2,50 €
10592	44	2,55 €
10593	44	3,15 €
10594	44	3,20 €
10595	44	3,35 €
10596	44	4,25 €
10597	44	4,50 €
10598	44	4,60 €
10599	44	6,00 €
10600	44	6,25 €
10601	44	6,50 €
10602	44	7,05 €
10603	44	2,10 €
10604	44	2,25 €
10617	46	14,10 €
10618	46	15,10 €
10619	46	15,70 €
10620	46	16,20 €
10621	46	9,50 €
10622	46	10,00 €
10623	46	12,60 €
10624	46	13,50 €
10625	46	15,70 €
10626	46	17,80 €
10627	44	2,80 €
10628	44	3,10 €
10629	44	3,65 €
10630	44	3,90 €
10631	44	4,20 €
10632	44	5,30 €
10633	44	6,60 €
10634	44	7,80 €
10635	44	8,15 €
10636	44	8,80 €
10637	44	12,10 €
10638	44	12,70 €
10642	57	10,00 €

REF.	PAGE	PRICE
10643	57	10,00 €
10644	57	10,00 €
10672	242	9,50 €
10673	242	9,50 €
10674	242	9,50 €
10675	242	9,50 €
10732	89	18,70 €
10735	89	20,30 €
10750	139	13,00 €
10751	139	15,00 €
10766	139, 357	1,59 €
10772	386	0,05 €
10773	386	0,10 €
10774	386	0,10 €
10775	386	0,15 €
10776	386	0,20 €
10777	386	0,20 €
10778	386	0,35 €
10779	385, 386	0,05 €
10780	385, 386	0,05 €
10781	385, 386	0,05 €
10782	386	0,05 €
10783	386	0,05 €
10784	385, 386	0,05 €
10785	385, 386	0,10 €
10786	385, 386	0,15 €
10787	386	0,05 €
10788	386	0,05 €
10789	386	0,05 €
10790	386	0,05 €
10791	386	0,05 €
10792	386	0,05 €
10793	382	0,25 €
10794	382	0,40 €
10795	382	0,60 €
10796	382	0,07 €
10797	382	0,09 €
10798	382	0,12 €
10799	382	0,13 €
10800	382	0,15 €
10801	382	0,17 €
10802	382	0,19 €
10803	382	0,05 €
10804	382	0,22 €
10805	385	0,10 €
10812	385	0,30 €
10813	385	0,30 €
10823	388	0,20 €
10824	388	0,20 €
10825	388	0,20 €
10826	388	0,40 €
10827	388	0,60 €
10828	388	0,45 €

REF.	PAGE	PRICE
10829	388	0,20 €
10830	388	0,20 €
10831	388	0,20 €
10832	388	0,20 €
10833	388	0,20 €
10834	388	0,25 €
10835	388	0,25 €
10836	388	0,30 €
10837	388	0,30 €
10838	388	0,30 €
10839	388	0,40 €
10840	388	0,35 €
10868	390	0,30 €
10869	390	0,30 €
10870	390	0,45 €
10871	390	0,30 €
10872	390	0,40 €
10873	390	0,45 €
10874	390	0,30 €
10875	390	0,40 €
10876	390	0,45 €
10877	384	0,25 €
10878	384	0,30 €
10879	384	0,20 €
10880	384	0,20 €
10881	384	0,25 €
10882	382	0,25 €
10883	382	0,25 €
10884	382	0,25 €
10885	394	0,20 €
10886	394	0,20 €
10887	394	0,25 €
10888	394	0,30 €
10889	394	0,30 €
10890	394	0,35 €
10891	394	0,25 €
10892	394	0,30 €
10893	394	0,25 €
10894	394	0,20 €
10895	394	0,20 €
10896	394	0,30 €
10897	394	0,30 €
10898	394	0,30 €
10899	394	0,30 €
10900	394	0,30 €
10901	394	0,25 €
10902	394	0,30 €
10905	394	0,25 €
10906	394	0,25 €
10907	394	0,25 €
10908	394	0,30 €
10909	394	0,30 €
10910	394	0,30 €

REF.	PAGE	PRICE
10911	394	0,30 €
10912	394	0,25 €
10913	394	0,30 €
10914	394	0,25 €
10915	393, 394	0,25 €
10916	394	0,30 €
10917	393, 394	0,30 €
10918	393, 394	0,30 €
10919	393, 394	0,30 €
10920	393, 394	0,25 €
10921	393, 394	0,30 €
10923	134	1,10 €
10953	229	12,50 €
10955	200	11,00 €
10961	144	13,00 €
10964	190, 350	9,00 €
10965	190, 350	6,00 €
10966	190, 350	13,50 €
11103	139	6,00 €
11106	202	3,00 €
11107	144	4,50 €
11121	168, 169, 176	4,10 €
11122	168, 169, 176	5,45 €
11123	168, 176	6,50 €
11124	176	7,65 €
11125	176	8,50 €
11126	176	11,20 €
11127	176	13,80 €
11128	176	14,10 €
11129	176	14,10 €
11130	176	13,10 €
11131	176	14,10 €
11132	176	13,70 €
11133	176	12,00 €
11134	176	15,00 €
11135	176	17,20 €
11136	176	15,30 €
11137	176	18,20 €
11138	176	18,00 €
11139	176	18,80 €
11140	176	20,40 €
11141	176	18,60 €
11142	176	21,30 €
11143	176	26,40 €
11144	176	33,30 €
11145	176	35,30 €
11146	176	37,30 €
11147	176	41,00 €
11148	176	47,00 €
11149	176	45,00 €
11150	176	55,00 €
11151	176	57,00 €
11152	176	57,00 €
11153	172, 176	23,40 €
11154	176	21,70 €
11155	172, 176	24,40 €

REF.	PAGE	PRICE
11156	176	28,90 €
11157	176	26,60 €
11158	172, 176	28,50 €
11159	176	30,30 €
11160	176	27,00 €
11161	176	32,30 €
11162	176	29,10 €
11163	176	32,70 €
11164	176	30,70 €
11165	176	34,60 €
11166	176	30,90 €
11167	176	38,00 €
11168	176	41,00 €
11169	176	39,20 €
11170	176	40,00 €
11171	176	51,00 €
11172	176	48,00 €
11173	176	47,00 €
11174	176	47,00 €
11175	176	49,00 €
11176	176	56,00 €
11177	176	55,00 €
11178	176	53,00 €
11179	176	65,00 €
11180	176	59,00 €
11181	176	65,00 €
11182	176	73,00 €
11183	176	70,00 €
11184	176	87,00 €
11185	176	97,00 €
11186	176	91,00 €
11187	176	98,00 €
11188	176	103,00 €
11189	176	121,00 €
11190	176	138,00 €
11191	176	149,00 €
11192	176	152,00 €
11193	176	183,00 €
11194	176	176,00 €
11195	168, 169, 176	3,70 €
11212	63	5,00 €
11213	63	10,60 €
11214	63	12,50 €
11244	45	8,50 €
11245	45	9,15 €
11246	45	12,40 €
11247	45	14,00 €
11248	45	14,60 €
11249	45	26,50 €
11258	43	7,30 €
11259	43	8,30 €
11260	43	9,75 €
11261	43	11,35 €
11262	43	13,50 €
11314	173	8,50 €
11315	173	8,50 €
11316	173	8,50 €

REF.	PAGE	PRICE
11318	410	2,50 €
11324	139	17,50 €
11325	139	17,50 €
11328	355	4,00 €
11330	412	0,57 €
11360	32	2,60 €
11361	32	3,20 €
11362	32	5,20 €
11363	32	3,90 €
11364	32	4,50 €
11365	32	9,40 €
11374	200	5,50 €
11375	200	6,50 €
11376	200	5,50 €
11377	200	5,50 €
11378	200	6,50 €
11379	200	6,00 €
11380	200	6,50 €
11381	200	6,50 €
11382	200	6,00 €
11383	200	6,00 €
11384	200	6,00 €
11385	200	5,50 €
11386	200	6,00 €
11387	200	6,00 €
11388	200	6,00 €
11389	200	6,00 €
11390	200	6,00 €
11391	200	6,50 €
11392	200	6,00 €
11393	200	6,00 €
11394	200	6,00 €
11434	226	12,00 €
11435	226	12,00 €
11436	226	12,00 €
11437	226	12,00 €
11438	226	12,00 €
11439	226	12,00 €
11440	226	12,00 €
11441	226	12,00 €
11442	226	12,00 €
11443	227	14,00 €
11444	227	14,00 €
11445	227	15,00 €
11446	227	15,00 €
11447	227	15,50 €
11450	226	12,00 €
11541	180	11,00 €
11542	180	11,00 €
11543	180	11,00 €
11544	180	7,00 €
11545	180	11,00 €
11546	180	12,00 €
11547	180	12,00 €
11613	176	11,00 €
11614	176	13,00 €
11615	176	14,20 €

REF.	PAGE	PRICE
11616	176	18,10 €
11617	176	18,70 €
11618	176	18,80 €
11619	176	19,50 €
11621	176	290,00 €
11622	176	399,00 €
11623	176	489,00 €
11624	176	189,00 €
11625	176	282,00 €
11628	173	9,50 €
11639	43	4,00 €
11640	43	4,50 €
11641	43	5,00 €
11642	43	5,00 €
11643	43	6,00 €
11644	43	7,00 €
11645	43	7,00 €
11646	43	9,45 €
11867	308	9,00 €
11878	214	4,10 €
11879	214	5,10 €
11880	214	10,50 €
11890	359	0,55 €
11891	359	0,50 €
11893	211	7,00 €
11894	211	7,00 €
11895	211	8,65 €
11896	211	8,80 €
11897	190, 351	155,00 €
11900	370	3,50 €
11901	370	2,50 €
11902	370	3,50 €
11903	370	5,00 €
11904	370	2,00 €
11905	370	1,50 €
11906	370	8,50 €
11907	370	11,00 €
11936	202	4,00 €
11937	202	5,00 €
11938	174	47,00 €
11945	53	7,00 €
11946	53	4,50 €
11947	53	19,00 €
11956	152	5,50 €
11957	152	5,50 €
11959	189	10,50 €
11960	369, 370	1,50 €
11962	32, 168, 169, 175	7,50 €
11963	175	9,00 €
11964	32, 175	12,50 €
11965	175	16,00 €
11966	175	18,00 €
11967	175	18,00 €
11971	99	3,60 €
11974	339	1,80 €
11975	339	1,80 €
11976	339	1,80 €

REF.	PAGE	PRICE
11977	339	1,80 €
11978	339	1,80 €
11979	339	1,80 €
11980	339	1,80 €
11981	339	1,80 €
11982	339	1,80 €
11983	339	1,80 €
11989	144	2,00 €
11990	168, 169, 174	15,30 €
11994	89	33,00 €
11996	88	48,00 €
11997	88	39,00 €
11998	88	49,00 €
12009	162	11,00 €
12022	188	33,70 €
12029	35	5,50 €
12030	35	6,50 €
12044	305	147,00 €
12055	351	20,00 €
12060	64	2,50 €
12061	169, 170, 176	9,50 €
12062	169, 170, 176	9,50 €
12063	169, 170, 176	9,50 €
12064	169, 176	9,00 €
12065	169, 170, 176	9,00 €
12066	169, 170, 172, 176	9,00 €
12067	169, 176	9,50 €
12068	169, 170, 172, 176	9,50 €
12069	169, 170, 172, 176	9,50 €
12070	169, 170, 176	10,50 €
12071	169, 170, 176	11,00 €
12072	169, 176	12,00 €
12074	169, 174	11,50 €
12075	168, 169, 174	15,50 €
12093	226	12,00 €
12200	219	14,50 €
12901	207	5,20 €
12926	241	21,50 €
12927	241	21,50 €
12928	241	22,00 €
12929	241	23,00 €
12930	241	23,50 €
12931	171	7,50 €
12932	171	7,50 €
12933	171	8,00 €
12934	171	7,50 €
12935	171	8,00 €
12936	171	8,50 €
12937	168, 169, 174	9,50 €
12938	171	10,00 €
12939	171	10,00 €
12940	171	10,00 €
12941	171	10,00 €

REF.	PAGE	PRICE
12942	171	10,00 €
12943	171	10,00 €
12944	171	10,00 €
12945	171	10,50 €
12950	412	3,45 €
12952	412	1,92 €
12954	394	0,25 €
12955	180	27,80 €
12956	180	27,80 €
12957	180	27,80 €
12958	180	27,80 €
12959	180	27,80 €
12960	180	27,80 €
12961	180	27,80 €
12973	370	1,00 €
12974	196	21,00 €
12975	196	23,00 €
12977	221	36,50 €
12984	176	379,00 €
12987	152	1,50 €
12988	166	12,00 €
12995	53	7,00 €
12996	53	7,00 €
12997	53	7,50 €
12998	53	9,00 €
12999	53	9,50 €
13002	396	1,45 €
13003	396	1,70 €
13004	396	1,85 €
13005	396	1,25 €
13006	396	1,40 €
13007	396	1,30 €
13008	396	2,25 €
13009	396	1,65 €
13010	396	1,75 €
13011	396	1,15 €
13012	396	1,80 €
13013	396	1,75 €
13014	396	1,45 €
13015	396	1,20 €
13016	396	1,15 €
13017	396	2,60 €
13018	396	1,45 €
13019	396	1,75 €
13020	396	1,70 €
13021	396	1,30 €
13022	396	2,10 €
13023	396	1,50 €
13024	396	2,45 €
13025	396	1,50 €
13026	400	1,55 €
13027	400	1,85 €
13028	400	1,45 €
13029	400	1,65 €
13030	400	2,80 €
13031	400	1,85 €
13032	400	2,00 €

REF.	PAGE	PRICE
13033	400	1,60 €
13034	400	2,65 €
13035	400	1,65 €
13036	400	1,40 €
13037	400	2,10 €
13038	398	1,40 €
13039	398	1,65 €
13040	398	1,80 €
13041	398	1,55 €
13042	398	1,95 €
13043	398	1,20 €
13044	398	1,55 €
13045	398	1,20 €
13046	398	1,55 €
13047	398	1,45 €
13048	398	2,20 €
13049	398	2,05 €
13050	399	1,55 €
13051	399	1,50 €
13052	399	1,25 €
13053	399	2,80 €
13054	399	2,35 €
13055	399	3,00 €
13056	398	1,55 €
13057	398	1,50 €
13058	398	2,20 €
13059	398	2,35 €
13060	398	1,60 €
13061	398	2,65 €
13062	398	2,35 €
13063	398	1,15 €
13064	398	2,60 €
13065	398	2,00 €
13066	398	2,25 €
13067	398	2,55 €
13068	399	2,85 €
13069	399	4,55 €
13070	399	2,15 €
13071	399	2,05 €
13072	399	2,75 €
13073	399	2,10 €
13074	400	4,65 €
13075	400	5,35 €
13076	400	3,90 €
13077	400	2,55 €
13078	400	2,55 €
13079	400	3,35 €
13080	398	1,75 €
13081	398	2,30 €
13082	398	1,35 €
13083	398	1,50 €
13084	398	2,10 €
13085	398	1,60 €
13086	398	1,25 €
13087	398	3,30 €
13088	398	2,40 €
13089	398	1,70 €

REF.	PAGE	PRICE
13090	398	1,70 €
13091	398	1,25 €
13092	400	1,65 €
13093	400	2,95 €
13094	400	1,50 €
13095	400	1,20 €
13096	400	1,70 €
13097	400	1,20 €
13098	400	1,65 €
13099	400	2,75 €
13100	400	1,20 €
13101	400	1,50 €
13102	400	1,60 €
13103	400	1,80 €
13104	396	1,90 €
13105	396	2,50 €
13106	396	2,00 €
13107	396	2,15 €
13108	396	1,90 €
13109	396	2,90 €
13110	396	1,85 €
13111	396	1,20 €
13112	396	1,65 €
13113	396	2,20 €
13114	396	2,20 €
13115	396	2,50 €
13116	399	5,45 €
13117	399	3,65 €
13118	399	15,90 €
13119	399	5,60 €
13120	399	5,50 €
13121	399	8,75 €
13122	399	1,95 €
13123	399	5,35 €
13124	399	8,20 €
13125	399	5,95 €
13126	399	1,55 €
13127	399	5,60 €
13128	397	1,85 €
13129	397	2,00 €
13130	397	3,75 €
13131	397	3,45 €
13132	397	2,65 €
13133	397	3,45 €
13134	397	3,95 €
13135	397	3,45 €
13136	397	2,60 €
13137	397	2,25 €
13138	397	2,85 €
13139	397	3,85 €
13140	397	2,65 €
13141	397	1,80 €
13142	397	3,10 €
13143	397	1,95 €
13144	397	2,20 €
13145	397	3,85 €
13146	397	4,50 €

REF.	PAGE	PRICE
13147	397	3,10 €
13148	397	3,30 €
13149	397	3,10 €
13150	397	2,25 €
13151	397	5,35 €
13152	397	3,05 €
13153	397	3,10 €
13154	397	3,20 €
13155	397	5,60 €
13156	397	3,30 €
13157	397	3,85 €
13158	397	3,75 €
13159	397	3,20 €
13160	397	5,00 €
13161	397	3,55 €
13162	397	2,60 €
13163	397	2,80 €
13217	412	1,31 €
13226	67	4,50 €
13227	67	4,50 €
13228	67	4,50 €
13229	67	4,50 €
13230	67	4,50 €
13231	67	4,50 €
13232	67	4,50 €
13234	305	224,50 €
13235	384	0,15 €
13236	384	0,15 €
13237	384	0,15 €
13238	384	0,20 €
13239	384	0,20 €
13240	384	0,40 €
13241	384	0,55 €
13447	40	16,50 €
13448	40	17,50 €
13449	40	20,00 €
13450	40	23,00 €
13451	40	28,00 €
13452	40	29,50 €
13453	39	9,00 €
13454	39	9,50 €
13455	39	10,50 €
13456	39	11,50 €
13457	39	12,00 €
13460	39	15,00 €
13462	39	17,00 €
13463	40	5,30 €
13464	40	5,30 €
13465	38, 39, 40	5,55 €
13466	38, 39, 40	5,55 €
13467	38, 39, 40	6,00 €
13468	38, 39, 40	6,25 €
13469	38, 39, 40	6,25 €
13470	38, 39, 40	6,60 €
13471	38, 39, 40	6,90 €
13472	38, 39, 40	7,25 €
13473	38, 39, 40	8,10 €

REF.	PAGE	PRICE
13474	38, 39, 40	8,70 €
13475	38, 39, 40	9,10 €
13476	38, 39, 40	9,60 €
13477	40	9,85 €
13478	40	12,20 €
13479	40	13,10 €
13480	40	15,50 €
13481	40	15,80 €
13482	40	22,10 €
13483	40	25,50 €
13484	40	27,20 €
13491	40	5,30 €
13492	40	5,35 €
13493	40	5,50 €
13494	40	6,00 €
13495	40	6,40 €
13496	40	6,60 €
13497	40	7,50 €
13498	40	8,50 €
13499	162	12,50 €
13500	162	12,90 €
13667	66, 89	17,60 €
13668	88	18,70 €
13674	68, 383	0,50 €
13675	68, 383	0,50 €
13676	68, 383	0,50 €
13677	68, 383	0,50 €
13678	68, 383	0,50 €
13680	174	15,50 €
13681	174	15,50 €
13682	174	15,50 €
13683	174	15,50 €
13684	174	15,50 €
13685	174	15,50 €
13686	174	15,50 €
13687	174	15,50 €
13688	174	15,50 €
13689	174	15,50 €
13704	69	21,00 €
13707	59	14,00 €
13708	59	14,00 €
13709	59	14,00 €
13710	59	14,00 €
13712	59	14,00 €
13717	412	7,65 €
13723	176	18,50 €
13724	176	19,20 €
13725	176	19,20 €
13726	176	19,00 €
13727	176	18,70 €
13728	176	18,50 €
13729	176	22,00 €
13730	176	22,00 €
13731	176	21,60 €
13732	176	23,80 €
13733	176	24,90 €
13734	176	25,70 €

REF.	PAGE	PRICE
13735	176	25,80 €
13736	176	25,90 €
13738	360	3,50 €
13739	360	5,50 €
13740	360	5,50 €
13741	372	21,00 €
13745	176	25,20 €
13746	176	25,40 €
13747	176	25,40 €
13748	176	24,90 €
13805	370	10,50 €
13806	370	10,50 €
13809	166	18,50 €
13810	166	20,50 €
13813	185	7,00 €
13814	185	11,00 €
13817	151	17,00 €
13818	151	20,50 €
13819	388	6,50 €
13820	388	7,00 €
13821	388	14,00 €
13822	388	11,00 €
13823	388	6,00 €
13824	388	8,00 €
13825	388	11,50 €
13826	388	13,00 €
13827	388	15,00 €
13828	388	11,50 €
13829	388	10,50 €
13830	388	10,50 €
13831	388	12,60 €
13832	388	13,00 €
13833	388	9,00 €
13839	144	8,50 €
13842	180	8,50 €
13843	180	7,00 €
13844	180	9,00 €
13845	180	8,00 €
13856	202	7,80 €
13859	172	16,00 €
13874	172	17,50 €
13875	172	18,50 €
13876	172	18,50 €
13877	172	18,50 €
13879	360	1,38 €
13880	360	1,50 €
13923	89	7,45 €
13929	406, 410	3,45 €
13930	165	1,50 €
13931	165	2,50 €
13932	165	2,50 €
13933	165	2,00 €
13934	165	2,50 €
13935	165	2,50 €
13936	165	3,50 €
13937	165	4,00 €
13938	165	3,50 €

REF.	PAGE	PRICE
13939	165	4,00 €
13945	387	7,40 €
13946	387	6,70 €
13947	387	5,85 €
13948	387	5,00 €
13949	387	6,50 €
13950	387	7,80 €
13951	387	5,15 €
13952	387	10,90 €
13953	387	8,00 €
13954	387	12,70 €
13955	387	4,95 €
13956	387	4,30 €
13957	387	9,70 €
13958	387	5,45 €
13959	387	10,10 €
13960	387	9,65 €
13961	387	9,25 €
13962	387	1,76 €
13963	387	12,40 €
13964	387	15,00 €
13965	387	1,50 €
13966	387	12,90 €
13967	387	4,65 €
13968	409	1,35 €
13969	204	19,00 €
13982	303	4,00 €
14004	171	9,50 €
14005	171	10,50 €
14006	171	9,50 €
14007	171	9,50 €
14008	171	9,50 €
14009	171	9,50 €
14010	171	11,00 €
14011	171	11,00 €
14013	152	3,50 €
14026	53	5,50 €
14027	53	5,60 €
14029	53	8,50 €
14030	53	9,50 €
14031	131, 144	7,90 €
14032	144	12,00 €
14033	144	4,50 €
14034	410	9,00 €
14049	237	8,00 €
14050	237	10,50 €
14051	237	18,00 €
14052	237	19,50 €
14075	165	2,00 €
14076	165	1,50 €
14077	165	4,50 €
14078	165	4,00 €
14083	412	13,20 €
14114	89	19,30 €
14118	365	26,00 €
14120	146	22,00 €
14121	146	26,00 €

REF.	PAGE	PRICE
14122	148	34,00 €
14123	148	33,00 €
14124	150	20,50 €
14125	150	19,50 €
14126	153	54,00 €
14127	155	32,50 €
14129	151	12,50 €
14130	151	21,00 €
14131	149	24,00 €
14133	155	16,50 €
14135	155	12,50 €
14136	152	12,00 €
14137	159	131,00 €
14145	328	8,50 €
14146	328	8,00 €
14147	328	25,00 €
14148	328	25,00 €
14153	149	20,50 €
14154	153	42,00 €
14157	161	8,30 €
14158	161	9,95 €
14159	161	12,60 €
14160	161	12,80 €
14161	161	13,70 €
14162	153	25,50 €
14163	153	25,50 €
14164	153	25,50 €
14165	146	26,50 €
14167	70	2,50 €
14168	160	7,00 €
14169	163	3,00 €
14172	173	8,50 €
14173	173	9,50 €
14177	173	9,50 €
14178	173	9,50 €
14179	58	8,50 €
14180	58	7,90 €
14183	68	31,00 €
14187	219	6,00 €
14188	160	0,50 €
14189	412	52,00 €
14190	165	2,00 €
14191	165	2,00 €
14192	165	4,00 €
14193	165	4,00 €
14195	166	4,00 €
14196	166	4,00 €
14197	166	4,50 €
14198	166	4,00 €
14199	166	4,00 €
14200	166	4,50 €
14201	165	4,00 €
14202	165	4,00 €
14203	165	4,50 €
14204	165	1,50 €
14205	165	1,50 €
14206	165	1,50 €

REF.	PAGE	PRICE
14207	165	1,50 €
14208	165	1,50 €
14209	165	1,50 €
14211	237	11,00 €
14212	237	12,00 €
14213	237	12,00 €
14214	237	14,00 €
14286	153	2,99 €
14287	153	2,99 €
14288	153	6,00 €
14289	153	6,10 €
14296	74, 75, 76, 77, 83	118,00 €
14297	74, 75, 76, 77, 83	87,00 €
14298	74, 75, 76, 77, 83	51,50 €
14299	74, 75, 76, 77, 83	87,00 €
14300	220	19,00 €
14301	220	19,00 €
14314	166	5,00 €
14315	166	4,50 €
14330	153	3,50 €
14336	149	58,00 €
14340	237	10,50 €
14341	237	10,50 €
14342	237	10,50 €
14343	237	10,50 €
14344	237	11,00 €
14345	237	11,00 €
14346	237	11,00 €
14347	408	36,50 €
14348	212	12,50 €
14349	212	20,50 €
14350	403, 404	1,80 €
14351	404	1,65 €
14352	404	1,30 €
14353	404	2,10 €
14354	90	14,00 €
14355	404	1,70 €
14356	404	1,90 €
14357	404	1,90 €
14358	403, 404	1,70 €
14359	401, 404	1,05 €
14361	404	1,70 €
14364	404	1,90 €
14365	404	1,90 €
14366	404	1,45 €
14367	404	1,30 €
14368	404	1,45 €
14369	404	4,95 €
14370	404	3,00 €
14371	404	3,00 €
14372	404	1,20 €
14373	404	1,35 €
14374	403	1,70 €
14375	403	1,85 €
14376	403	2,60 €
14377	403	1,90 €

REF.	PAGE	PRICE
14378	403	1,90 €
14379	403	1,45 €
14380	411	51,00 €
14381	403	1,70 €
14382	403	1,85 €
14383	403	1,35 €
14384	403	2,10 €
14387	403	1,45 €
14388	403	2,05 €
14389	403	1,25 €
14390	403	1,35 €
14391	403	2,15 €
14392	403	1,35 €
14393	403	1,50 €
14395	403	1,65 €
14396	403	1,20 €
14397	403	1,45 €
14398	403	1,30 €
14399	403	1,90 €
14402	403	1,50 €
14404	403	2,10 €
14405	403	1,45 €
14406	403	1,55 €
14408	403	1,45 €
14409	403	1,35 €
14410	402	1,85 €
14411	402	1,70 €
14412	402	1,70 €
14413	402	3,25 €
14414	402	1,70 €
14415	402	1,70 €
14416	402, 403	1,25 €
14419	402	1,95 €
14420	402	1,50 €
14421	402	2,45 €
14422	401, 402	1,50 €
14423	402	3,55 €
14424	402	1,85 €
14425	402	2,05 €
14426	402	1,90 €
14427	402	1,20 €
14428	402	1,40 €
14429	402	1,80 €
14430	402	2,25 €
14431	402	1,45 €
14432	402	1,45 €
14434	402	1,60 €
14435	402	1,45 €
14436	402	1,70 €
14437	402	1,45 €
14438	402	1,35 €
14439	402	1,75 €
14440	402	1,75 €
14441	402	1,65 €
14442	402	1,45 €
14443	402	1,45 €
14444	402	1,90 €

REF.	PAGE	PRICE
14445	402	1,45 €
14446	401	2,80 €
14447	401	1,45 €
14448	401	2,05 €
14449	401	2,20 €
14450	401	2,15 €
14451	401	2,15 €
14452	401	2,55 €
14453	401	3,05 €
14455	401	2,10 €
14456	401	1,35 €
14457	401	1,70 €
14458	401	1,70 €
14459	401	1,45 €
14460	401	1,15 €
14461	401	1,35 €
14462	401	1,65 €
14463	401	1,65 €
14464	401	1,50 €
14465	401	2,00 €
14466	401	1,65 €
14468	401	1,30 €
14469	401	1,45 €
14471	401	1,90 €
14472	401	1,35 €
14474	401	1,50 €
14475	401	1,65 €
14476	401	2,05 €
14477	401	2,45 €
14478	401	4,05 €
14479	401	1,65 €
14480	401	2,05 €
14481	401	1,70 €
14507	412	50,00 €
14534	161	16,50 €
14560	161	8,80 €
14561	166	8,80 €
14563	214	18,00 €
14564	183	9,20 €
14565	183	26,70 €
14566	183	16,70 €
14567	183	38,00 €
14568	183	9,20 €
14569	183	9,20 €
14570	183	4,05 €
14571	183	9,20 €
14573	183	4,05 €
14578	92	12,50 €
14580	92	41,00 €
14583	148	6,00 €
14594	221, 389	2,00 €
14595	221, 389	1,50 €
14596	221, 389	2,00 €
14597	221, 389	7,60 €
14598	221, 389	17,80 €
14599	221, 389	4,50 €
14600	221, 389	9,50 €

REF.	PAGE	PRICE
14601	221, 389	11,00 €
14602	221, 389	11,00 €
14611	240	12,00 €
14612	240	11,00 €
14613	240	13,50 €
14616	321	96,00 €
14618	147	19,00 €
14622	123, 410	17,00 €
14623	123, 410	8,00 €
14624	123, 410	17,00 €
14625	123, 410	14,00 €
14626	123, 410	7,00 €
14633	147	22,50 €
14710	183	3,50 €
14711	183	3,75 €
14712	183	4,00 €
14713	183	4,25 €
14714	183	4,50 €
14715	183	4,75 €
14723	172	18,00 €
14724	172	18,50 €
14725	172	18,50 €
14726	172	17,50 €
14728	168, 169, 176	3,80 €
14729	168, 169, 176	3,80 €
14730	168, 169, 176	3,80 €
14731	168, 169, 176	3,80 €
14732	168, 169, 176	3,80 €
14733	168, 169, 176	4,30 €
14734	168, 169, 176	5,40 €
14735	169	6,50 €
14736	170, 176	5,00 €
14737	170, 176	5,00 €
14738	170, 176	5,50 €
14739	170, 176	5,50 €
14740	170, 176	5,55 €
14741	170, 176	5,55 €
14742	170, 176	5,55 €
14743	170, 176	5,15 €
14744	170, 176	5,35 €
14745	170, 176	6,25 €
14746	170, 176	6,40 €
14747	170, 176	7,10 €
14748	170, 176	8,30 €
14749	32, 175	2,00 €
14750	32, 175	2,00 €
14751	32, 175	4,00 €
14752	32, 175	4,00 €
14753	143	13,00 €
14771	164, 338	10,50 €
14772	164	8,50 €
14774	338	10,50 €
14775	380	30,50 €
14779	150	33,00 €
14781	377	990 €

REF.	PAGE	PRICE
14783	92	5,50 €
14793	378	12,00 €
14803	380	43,00 €
14807	412	11,00 €
14825	123	1,50 €
14826	123	1,50 €
14827	123	2,00 €
14828	123	1,50 €
14829	123	1,50 €
14830	123	1,50 €
14831	123	1,50 €
14832	123	2,00 €
14833	123	2,05 €
14834	123	2,50 €
14835	123	3,00 €
14836	123	3,50 €
14837	123	3,30 €
14838	123	3,40 €
14839	123	4,70 €
14840	123	3,35 €
14841	124	2,58 €
14842	124	9,50 €
14843	125	0,50 €
14844	125	0,50 €
14845	125	0,50 €
14846	125	0,50 €
14847	125	0,50 €
14848	125	0,50 €
14849	125	1,00 €
14850	125	1,00 €
14851	125	1,00 €
14852	125	1,00 €
14853	125	1,00 €
14854	125	1,00 €
14855	125	1,00 €
14856	125	1,00 €
14857	125	1,50 €
14858	125	1,50 €
14859	125	1,50 €
14860	125	2,00 €
14861	125	2,00 €
14862	125	2,00 €
14863	125	2,50 €
14864	125	2,50 €
14865	125	2,50 €
14866	125	3,00 €
14867	125	3,00 €
14868	125	0,55 €
14869	125	0,60 €
14870	125	1,00 €
14871	125	1,00 €
14872	125	1,00 €
14873	125	1,00 €
14874	125	1,00 €
14875	125	1,50 €
14876	125	1,50 €
14877	125	1,50 €

REF.	PAGE	PRICE
14878	125	2,00 €
14879	125	2,00 €
14880	125	2,50 €
14881	125	2,50 €
14882	125	3,00 €
14883	125	3,50 €
14884	125	3,65 €
14885	125	4,00 €
14886	125	4,60 €
14887	125	5,00 €
14888	125	6,00 €
14889	125	6,50 €
14890	125	7,00 €
14891	125	7,50 €
14892	125	8,00 €
14893	128	2,00 €
14894	128	1,20 €
14895	128	1,90 €
14896	128	2,10 €
14897	128	0,88 €
14898	128	0,98 €
14899	128	0,88 €
14900	128	0,98 €
14901	124	3,60 €
14902	124	4,65 €
14903	124	5,25 €
14904	124	6,85 €
14905	124	8,50 €
14906	124	10,20 €
14907	124	0,50 €
14908	124	0,60 €
14909	124	0,80 €
14910	124	1,00 €
14911	124	1,30 €
14912	124	1,55 €
14913	124	1,90 €
14914	124	2,10 €
14915	124	2,65 €
14916	124	2,95 €
14917	124	3,45 €
14920	123	2,50 €
14922	412	0,84 €
14923	412	0,84 €
14924	412	0,84 €
14925	412	0,84 €
14926	412	1,05 €
14930	204	9,50 €
14931	204	8,00 €
14932	204	9,50 €
14933	204	9,50 €
14934	124	4,25 €
14935	124	8,45 €
14945	411	303,50 €
14946	411	58,00 €
14947	411	201,50 €
14948	411	251,50 €
14950	116	6,50 €

REF.	PAGE	PRICE
14951	116	9,50 €
14952	116	19,00 €
14953	116	8,50 €
14970	168	2,50 €
14971	168	2,50 €
14972	168	3,50 €
14973	168, 169	11,50 €
14974	412	2,28 €
14975	410	64,00 €
14976	412	18,84 €
14978	53	7,50 €
14979	53	9,00 €
14980	53	13,00 €
14981	53	22,50 €
14982	53	27,50 €
14985	128	6,00 €
14986	128	4,00 €
14987	128	8,50 €
14988	128	8,00 €
14989	128	6,00 €
14990	128	10,50 €
14991	128	2,00 €
14992	200	8,50 €
14993	128	5,00 €
14994	128	3,50 €
14995	128	8,00 €
14996	411	65,00 €
15010	97	16,50 €
15011	97	18,00 €
15012	97	31,50 €
15014	127	20,00 €
15023	92	12,50 €
15024	92	15,00 €
15025	92	12,50 €
15026	92	15,00 €
15030	92	8,00 €
15033	92	6,00 €
15034	92	57,00 €
15035	92	8,50 €
15036	92	8,50 €
15037	92	8,00 €
15038	92	34,50 €
15040	92	12,50 €
15041	92	15,00 €
15042	92	7,50 €
15049	117	37,40 €
15050	92	9,50 €
15051	412	1,92 €
15052	219	3,00 €
15053	219	10,50 €
15054	219	34,00 €
15056	412	11,70 €
15058	92	7,50 €
15059	378	10,00 €
15062	378	1,00 €
15065	92	6,50 €
15068	90	15,20 €

REF.	PAGE	PRICE
15069	90	32,80 €
15070	82	0,50 €
15071	82	0,60 €
15072	82	0,70 €
15073	82	1,00 €
15074	82	1,00 €
15075	82	1,20 €
15076	82	3,50 €
15083	88	8,50 €
15084	88, 203, 307	68,00 €
15093	317	38,00 €
15094	317	39,50 €
15095	317	13,00 €
15096	317	40,00 €
15122	39, 75, 85	74,00 €
15138	51	10,50 €
15139	51	12,00 €
15140	51	13,50 €
15144	93	30,00 €
15145	94	20,45 €
15146	94	16,20 €
15147	50	5,00 €
15148	50	5,00 €
15149	50	5,00 €
15152	408	160,00 €
15155	75, 85	59,00 €
15156	43, 85	70,00 €
15157	85	42,00 €
15158	85	59,00 €
15159	85	44,00 €
15160	85	42,00 €
15161	75, 85	62,00 €
15162	36, 87, 345	30,20 €
15206	43	15,00 €
15207	43	16,50 €
15208	43	17,00 €
15209	43	18,00 €
15227	36	3,50 €
15228	36	4,00 €
15229	36	5,00 €
15230	36	5,00 €
15231	36	3,50 €
15232	36	4,00 €
15233	36	5,00 €
15234	36	3,00 €
15253	222, 225	62,00 €
15300	369	5,00 €
15313	90	14,00 €
15315	86	28,20 €
15316	39, 86	58,00 €
15317	369	4,50 €
15328	39	6,00 €
15329	39	5,50 €
15330	39	5,50 €
15331	39	5,50 €
15332	39	6,00 €
15333	39	6,50 €

REF.	PAGE	PRICE
15334	39	7,00 €
15335	39	7,50 €
15336	39	8,00 €
15337	39	8,50 €
15338	39	9,00 €
15339	39	9,50 €
15375	183	28,00 €
15385	135	18,00 €
15448	343	5,50 €
15454	57, 86	35,40 €
15460	343	5,00 €
15494	200	12,50 €
15495	200	12,50 €
15496	200	11,50 €
15497	200	11,00 €
15498	200	11,50 €
15499	200	11,00 €
15500	200	10,00 €
15501	200	10,00 €
15502	200	10,00 €
15503	200	11,00 €
15504	200	10,00 €
15505	200	4,00 €
15506	200	4,00 €
15507	200	4,50 €
15508	200	4,50 €
15509	200	5,00 €
15510	200	5,00 €
15511	200	8,00 €
15514	75, 86	9,35 €
15515	39	15,50 €
15516	39	19,00 €
15517	39	22,50 €
15541	86	27,60 €
15552	190, 351	181,00 €
15564	148	11,90 €
15619	355	4,00 €
15631	303	98,00 €
15632	38	9,00 €
15633	38	9,50 €
15634	38	11,00 €
15635	38	12,50 €
15636	38	14,00 €
15637	38	15,00 €
15681	85	134,00 €
15706	63, 86	31,00 €
15730	78, 84	289,00 €
15731	78, 84	214,00 €
15732	78, 84	293,50 €
15733	78, 84	113,00 €
15734	78, 84	288,50 €
15735	78, 84	152,00 €
15736	78, 84	488,50 €
15737	66, 86	45,00 €
15783	65	3,50 €
15784	65	3,50 €
15785	65	3,50 €

REF.	PAGE	PRICE
15786	65	3,50 €
15787	65	3,50 €
15799	63, 87	28,30 €
15866	350	32,00 €
15874	310	6,50 €
16010	46	4,00 €
16011	46	4,00 €
16012	46	4,00 €
16013	46	4,50 €
16014	46	4,50 €
16015	46	5,00 €
16016	46	5,00 €
16017	46	5,00 €
16018	46	5,50 €
16019	46	6,00 €
16020	41	17,00 €
16021	41	19,50 €
16022	41	23,00 €
16023	41	26,50 €
16024	41	34,50 €
16025	41	37,50 €
16052	137, 144	2,09 €
16053	137, 144	2,85 €
16111	61, 87	19,20 €
16130	343	290,00 €
16161	91	17,50 €
16162	91	35,10 €
16163	91	10,20 €
16188	91	39,60 €
16198	343	5,00 €
16237	237	23,00 €
16238	237	23,00 €
16239	237	23,00 €
16240	237	26,00 €
16241	237	23,00 €
16242	237	26,00 €
16243	237	23,00 €
16273	150	12,50 €
16294	395	14,00 €
16295	206	30,00 €
16300	227	7,60 €
16301	227	7,60 €
16302	227	7,60 €
16304	172	31,00 €
16305	172	31,00 €
16309	220	149,00 €
16316	221	18,50 €
16318	126	0,50 €
16319	126	0,50 €
16320	126	0,50 €
16321	126	1,00 €
16322	126	1,00 €
16323	126	1,00 €
16324	126	1,50 €
16325	126	1,50 €
16326	126	2,00 €
16327	126	2,00 €

REF.	PAGE	PRICE
16328	126	2,50 €
16329	126	3,00 €
16330	126	3,50 €
16331	126	3,50 €
16332	126	4,00 €
16333	126	4,50 €
16334	126	5,50 €
16335	126	6,00 €
16336	126	6,50 €
16341	147	32,50 €
16342	65	2,50 €
16343	65	2,50 €
16344	90	43,00 €
16354	90	1,50 €
16355	90	2,00 €
16356	90	2,50 €
16357	90	2,50 €
16358	90	12,00 €
16359	90	10,00 €
16360	90	12,00 €
16361	90	16,50 €
16362	90	20,00 €
16363	90	14,50 €
16364	123, 410	3,50 €
16366	206	11,00 €
16367	206	10,00 €
16368	206	12,00 €
16369	206	12,00 €
16370	206	12,00 €
16371	206	11,00 €
16372	206	11,50 €
16373	206	12,00 €
16374	206	12,00 €
16375	206	15,00 €
16376	206	15,00 €
16377	206	16,00 €
16378	206	15,00 €
16379	206	15,00 €
16380	206	16,00 €
16381	206	10,00 €
16382	206	10,00 €
16383	206	15,00 €
16384	206	15,00 €
16385	242	10,00 €
16386	242	11,50 €
16387	92	10,50 €
16388	242	11,50 €
16389	242	11,50 €
16391	39	4,60 €
16392	39	4,60 €
16393	39	4,60 €
16394	39	5,10 €
16395	39	5,10 €
16396	39	5,10 €
16397	39	5,50 €
16398	39	5,50 €
16399	39	5,50 €

REF.	PAGE	PRICE
16400	259	6,50 €
16401	39	6,10 €
16402	39	6,10 €
16403	39	6,10 €
16430	233	20,50 €
16431	233	20,50 €
16432	233	20,50 €
16433	233	20,50 €
16434	233	20,50 €
16435	233	21,50 €
16436	233	21,50 €
16448	222	16,50 €
16462	389	36,50 €
16463	389	36,50 €
16464	389	36,50 €
16465	389	39,50 €
16466	389	50,00 €
16467	389	36,50 €
16468	389	36,50 €
16469	389	36,50 €
16470	389	39,50 €
16471	389	50,00 €
16472	389	17,50 €
16473	389	17,50 €
16474	389	17,50 €
16475	389	17,50 €
16476	389	24,00 €
16477	389	24,50 €
16478	389	24,50 €
16479	389	7,50 €
16480	389	7,50 €
16481	93	14,00 €
16482	93	13,50 €
16490	73	650,00 €
16491	73	307,00 €
16492	73	675,00 €
16493	73	436,00 €
16494	73	139,00 €
16496	73	127,00 €
16497	73	77,00 €
16498	73	84,00 €
16499	73	162,00 €
16500	73	463,00 €
16516	73	121,00 €
16538	389	19,50 €
16539	389	18,00 €
16540	389	13,00 €
16541	389	13,00 €
16542	389	23,50 €
16543	389	13,00 €
16546	43	5,00 €
16547	43	5,50 €
16548	43	9,00 €
16549	43	14,00 €
16561	73	36,50 €
16564	147	17,00 €
16565	233	19,50 €

REF.	PAGE	PRICE
16566	233	22,50 €
16571	172	32,00 €
16572	172	33,50 €
16574	172	34,00 €
16575	172	34,50 €
16576	172	35,50 €
16577	172	36,00 €
16583	126	8,50 €
16584	126	10,50 €
16585	126	11,50 €
16586	126	13,00 €
16587	126	14,00 €
16588	126	15,00 €
16600	73	252,00 €
16627	73	225,00 €
16628	73	382,00 €
16629	73	419,00 €
16642	65	1,00 €
16737	226	12,00 €
50400	191	168,00 €
50403	191	98,00 €
50409	192	26,00 €
50410	191	168,00 €
50431	357	3,80 €
50517	350	129,00 €
50518	350	169,00 €
50523	357	4,70 €
50524	357	4,70 €
50525	365	1,00 €
50526	365	4,80 €
50551	357	350,00 €
50562	44	23,50 €
50564	42	30,00 €
50567	57	9,60 €
50577	186	12,60 €
50585	361	14,70 €
50600	368	0,60 €
50601	368	0,29 €
50622	46	64,00 €
50623	21	60,00 €
50630	324	590,00 €
50631	322	68,00 €
50632	335	298,00 €
50644	359	11,60 €
50651	391	18,00 €
50652	391	16,50 €
50654	354	4,00 €
50656	190, 351	290,00 €
50717	359	21,90 €
50724	69	28,00 €
50731	217	68,00 €
50751	156, 312	43,00 €
50760	368	0,10 €
50761	368	0,19 €
50762	368	0,29 €
50763	368	0,38 €
50764	368	0,49 €

REF.	PAGE	PRICE
50765	368	0,58 €
50766	368	0,68 €
50767	368	0,78 €
50768	368	0,88 €
50778	368	0,10 €
50779	368	0,19 €
50780	368	0,29 €
50781	368	0,38 €
50782	368	0,49 €
50783	368	0,58 €
50784	368	0,68 €
50785	368	0,78 €
50786	368	0,88 €
50787	98	8,00 €
50788	98	14,50 €
50789	98	29,00 €
50792	236	105,00 €
50793	236	94,00 €
50797	349	490,00 €
50807	221, 391	38,00 €
50808	99	77,00 €
50815	314	88,00 €
50816	315	88,00 €
50818	314	198,00 €
50819	316	28,00 €
50820	316	34,50 €
50821	316	47,00 €
50822	316	59,00 €
50823	316	94,00 €
50824	316	88,00 €
50825	316	154,00 €
50827	223, 321	387,00 €
50830	317	560,00 €
50831	322	460,00 €
50835	319	290,00 €
50836	323	148,00 €
50838	323	299,00 €
50839	320	180,00 €
50840	322	138,00 €
50843	99	79,00 €
50844	99	65,00 €
50852	312	24,50 €
50901	181	16,00 €
50902	54	13,00 €
50903	181	30,80 €
50910	142	45,00 €
50911	324	788,00 €
50913	190, 351	195,00 €
50915	357	4,20 €
50916	192	0,88 €
50917	305	271,00 €
50918	304	341,00 €
50923	188, 320	454,00 €
50924	308, 351	342,00 €
50935	304	595,00 €
50937	69	10,50 €
50942	331, 344	28,00 €

REF.	PAGE	PRICE
50957	95	22,00 €
50959	95, 386	14,00 €
50966	354	4,00 €
50966C	354	3,00 €
50980	34	22,00 €
50982	34	22,00 €
50983	30	48,00 €
50985	30	59,00 €
51017	56	6,80 €
51018	56	7,05 €
51020	56	6,65 €
51021	56	7,05 €
51028	172	163,00 €
51033	339	98,00 €
51035	94	799,00 €
51050	95	285,00 €
51051	95	34,80 €
51055	368	0,98 €
51059	195	99,00 €
51119	229	62,00 €
51120	213	41,00 €
51121	222	27,30 €
51123	229	91,00 €
51124	241	88,00 €
51125	238	88,00 €
51126	234	18,00 €
51127	52	56,00 €
51127R	52	14,00 €
51131	180	61,00 €
51140	240	64,00 €
51206	146	228,00 €
51207	146	289,00 €
51210	148	650,00 €
51211	148	560,00 €
51212	148	488,00 €
51213	148	690,00 €
51214	150	148,00 €
51215	150	119,00 €
51216	153	650,00 €
51218	155	288,00 €
51220	151	240,00 €
51221	151	199,00 €
51222	149	128,00 €
51226	155	233,00 €
51235	329	49,00 €
51238	328	138,00 €
51239	328	159,00 €
51245	155	99,00 €
51246	358	6,40 €
51253	305	41,00 €
51258	134	0,15 €
51259	231	58,00 €
51260	29	37,00 €
51262	52	51,00 €
51262R	52	14,00 €
51266	359	28,00 €
51272	62	7,50 €

REF.	PAGE	PRICE
51277	157	64,00 €
51283	196	78,00 €
51305	50	28,90 €
51306	50	28,10 €
51307	50	29,70 €
51315	410	2,50 €
51318	38	98,00 €
51326	134	4,40 €
51332	200	98,00 €
51333	32	18,00 €
51336	173	29,30 €
51337	204	50,00 €
51338	52	53,00 €
51338R	52	14,00 €
51340	296	39,30 €
51341	163	35,00 €
51347	230	9,90 €
51349	242	37,30 €
51352	201	9,80 €
51353	201	11,50 €
51354	202	13,20 €
51355	60, 369	19,00 €
51356	308	48,00 €
51358	371	7,50 €
51359	371	9,00 €
51360	181	8,05 €
51361	181	9,80 €
51362	371	3,00 €
51363	328	114,00 €
51364	221	26,00 €
51365	328	118,00 €
51368	224	19,00 €
51369	224	28,00 €
51383	157	11,10 €
51385	162	4,55 €
51386	162	5,95 €
51387	162	3,25 €
51388	153	22,00 €
51389	153	22,00 €
51390	153	22,00 €
51391	153	22,00 €
51392	153	34,00 €
51393	153	34,00 €
51398N	375	1,54 €
51400	204	17,00 €
51401	204	22,00 €
51402	204	20,50 €
51403	204	17,50 €
51405	50	21,10 €
51406	50	29,20 €
51409	33	36,00 €
51410	33	36,00 €
51412	364	2,10 €
51414	224	14,00 €
51416	47	12,00 €
51419	91	2,79 €
51422	91	2,97 €

REF.	PAGE	PRICE
51439	153	26,00 €
51440	153	28,00 €
51441	153	26,00 €
51442	153	28,00 €
51443	162	5,50 €
51444	162	5,05 €
51445	162	5,05 €
51447	53, 87	16,00 €
51448	53, 87	52,00 €
51452	322	69,00 €
51479	53	31,80 €
51488	273	16,00 €
51489	284	12,00 €
51490	225	36,00 €
51491	230	154,00 €
51493	207	68,00 €
51494	205	107,00 €
51495	232	59,00 €
51496	236	8,00 €
51500	240	29,00 €
51501	233	38,00 €
51504	63	8,50 €
51525	62	9,80 €
51526	62	9,80 €
51528	44	49,00 €
51538	388	0,15 €
51539	388	0,15 €
51540	388	0,15 €
51541	388	0,25 €
51542	388	0,20 €
51543	388	0,25 €
51544	388	0,25 €
51545	388	0,30 €
51546	389	0,19 €
51554	389	0,28 €
51573	134	2,50 €
51574	95	52,00 €
51575	96	317,00 €
51576	93	125,00 €
51600	96	109,00 €
51604	368	0,98 €
51612	357	5,95 €
51613	357	2,90 €
51614	357	3,60 €
51615	357	5,95 €
51616	23	378,00 €
51622	192	25,30 €
51632N	375	1,54 €
51633	375	1,54 €
51634	375	1,54 €
51636N	375	1,54 €
51638N	375	1,54 €
51640N	375	1,54 €
51642N	375	1,54 €
51653	91	5,10 €
51654	91	4,80 €
51655	91	4,10 €

REF.	PAGE	PRICE
51656	91	3,65 €
51657	91	5,85 €
51658	91	4,50 €
51659	46	59,00 €
51661	47	12,00 €
51674	63	7,75 €
51692	355	3,55 €
51693	355	3,55 €
51694	355	3,55 €
51696	355	3,55 €
51697	364	0,80 €
51703	359	10,50 €
51705	359	8,45 €
51706	366	22,80 €
51707	366	9,05 €
51708	366	14,20 €
51709	366	14,70 €
51710	366	17,80 €
51711	366	21,20 €
51712	366	8,65 €
51713	366	13,10 €
51714	366	15,80 €
51715	366	20,30 €
51716	366	23,60 €
51717	366	11,20 €
51718	366	14,80 €
51719	366	22,00 €
51720	366	23,50 €
51721	366	25,00 €
51722	366	13,10 €
51723	366	18,70 €
51724	366	24,40 €
51725	366	28,30 €
51726	366	31,40 €
51727	366	49,00 €
51737	94	699,00 €
51738	93	850,00 €
51741	370	0,50 €
51742	370	0,50 €
51743	370	0,55 €
51745	376	0,70 €
51746	34	12,00 €
51751	320	99,00 €
51785	376	1,00 €
51795	47	9,00 €
51796	47	14,00 €
51797	47	18,00 €
51798	47	39,60 €
51799	389	0,20 €
51801	51	62,00 €
51804	386	58,00 €
51805	53, 87	17,00 €
51812	56	46,00 €
51814	369	8,00 €
51816	329	58,00 €
51817	354	4,50 €
51818	18	109,00 €

REF.	PAGE	PRICE
51824	192	36,80 €
51830	52	94,00 €
51831	339	24,00 €
51832	181	18,00 €
51837	336	195,00 €
51838	336	667,00 €
51839	198	24,00 €
51842	330	6,90 €
51843	389	0,19 €
51853	70	18,00 €
51855	23	378,00 €
51858	364	15,00 €
51859	339	3,80 €
51861	159, 359	199,00 €
51863	366	54,00 €
51864	45, 87	64,00 €
51886	142	44,00 €
51889	130	49,00 €
51890	46	92,00 €
51895	315	99,00 €
51896	235	82,00 €
51897	235	122,00 €
51898	235	139,00 €
51899	235	137,00 €
51901	319	999,00 €
51902	229	84,00 €
51905	316	34,50 €
51906	316	39,00 €
51907	316	48,00 €
51908	368	44,00 €
51909	65	2,46 €
51918	63	12,50 €
51919	228	89,00 €
51920	234, 392	18,00 €
51923	201	12,50 €
51925	365	1,00 €
51927	296	25,00 €
51928	308	14,00 €
51929	143	22,00 €
51934	201	11,50 €
51935	354	135,00 €
51936	354	135,00 €
51937	354	135,00 €
51951	70	15,60 €
51958	228	422,00 €
51960	138	34,00 €
51961	138	34,00 €
51962	138	25,00 €
51963	138	29,00 €
51964	138	28,00 €
51965	138	29,50 €
51966	139	18,00 €
51967	144	16,00 €
51968	144	16,00 €
51969	139	14,00 €
51972	60	12,00 €
51973	366	45,00 €

REF.	PAGE	PRICE
51975	91	2,27 €
51976	91	1,63 €
51978	191	84,00 €
51980	156	15,00 €
51981	157	21,50 €
51982	349	120,00 €
51983	349	185,00 €
51984	349	190,00 €
51985	191	84,00 €
51986	234	11,90 €
51989	216	49,00 €
51991	230	54,00 €
51995	58, 59	24,50 €
51998	226	38,00 €
52010	239	80,00 €
52012	228	68,00 €
52016	235	2,10 €
52017	235	2,40 €
52018	235	2,60 €
52019	235	3,20 €
52021	235	3,40 €
52022	235	4,50 €
52023	235	6,60 €
52024	235	10,60 €
52025	235	13,00 €
52026	181	31,80 €
52027	382	14,00 €
52028	385	15,20 €
52029	385	14,00 €
52030	388	98,00 €
52031	387	44,00 €
52032	386	28,00 €
52033	390	43,00 €
52043	384	16,50 €
52044	382	19,00 €
52047	357	3,30 €
52048	357	3,95 €
52049	66	14,00 €
52050	59	98,00 €
52052	57	53,00 €
52053	394	45,00 €
52054	394	17,00 €
52055	322	139,00 €
52056	242	66,00 €
52057	191	6,80 €
52058	191	4,50 €
52059	35	29,00 €
52060	35	32,00 €
52065	191	45,00 €
52066	218	12,00 €
52069	328	29,50 €
52070	328	40,00 €
52071	328	47,00 €
52076	211	111,00 €
52077	183	29,50 €
52148	99	65,00 €
52149	349	230,00 €

REF.	PAGE	PRICE
52152	60	13,50 €
52153	227	46,00 €
52156	149	140,00 €
52157	155	48,00 €
52158	386	38,50 €
52159	151	64,00 €
52160	151	48,00 €
52162	79, 338, 346	38,00 €
52163	388	95,00 €
52165	149	118,00 €
52167	150	48,00 €
52169	55	25,00 €
52170	55	16,00 €
52171	155	39,00 €
52180	63	19,00 €
52181	63	22,50 €
52182	63	24,00 €
52183	63	26,20 €
52184	63	43,00 €
52185	63	55,00 €
52186	63	72,00 €
52187	364	21,80 €
52188	63	15,50 €
52190	216	8,00 €
52191	197	198,00 €
52195	334	170,00 €
52197	50	36,30 €
52198	32	37,70 €
52200	351	88,00 €
52202	351	88,00 €
52207	50	24,20 €
52227	223	247,00 €
52230	190, 350	398,00 €
52231	330	49,00 €
52233	330	328,00 €
52235	48	11,00 €
52236	48	13,30 €
52237	48	18,10 €
52238	48	24,90 €
52241	319	1.690,00 €
52242	311	12,00 €
52243	311	8,50 €
52244	191	84,00 €
52251	364	21,80 €
52254	135	64,00 €
52259	359	3,75 €
52262	185	7,50 €
52263	185	13,50 €
52264	185	18,60 €
52265	185	30,50 €
52269	202	7,00 €
52270	224	109,00 €
52271	283	18,00 €
52272	57	24,60 €
52273	212	44,00 €
52275	198	38,00 €
52293	231	98,00 €

REF.	PAGE	PRICE
52295	185	6,50 €
52296	239	119,00 €
52297	239	172,00 €
52298	239	177,00 €
52302	140	25,40 €
52303	140	26,40 €
52304	316	84,00 €
52305	205	106,00 €
52308	100	440,00 €
52309	100	941,00 €
52310	375	3,65 €
52311	201	19,00 €
52312	201	9,00 €
52313	201	8,00 €
52314	201	26,60 €
52315	198	16,00 €
52316	232	18,90 €
52317	232	19,90 €
52318	69	73,00 €
52319	232	8,80 €
52320	34	22,00 €
52321	186	8,80 €
52327	186	12,00 €
52328	197	99,00 €
52329	303	36,40 €
52330	194	99,00 €
52331	159	201,00 €
52337	168	65,00 €
52338	173	41,00 €
52339	171	61,00 €
52340	171	58,00 €
52341	169	58,00 €
52342	170	63,00 €
52343	173	52,00 €
52344	171	197,00 €
52345	168	109,00 €
52346	169	103,00 €
52347	171	158,00 €
52348	172	179,00 €
52349	48	22,10 €
52350	48	22,60 €
52351	48	25,40 €
52352	48	32,40 €
52353	48	33,40 €
52354	48	34,40 €
52355	48	36,60 €
52357	48	54,00 €
52358	48	63,00 €
52362	357	1,23 €
52363	357	1,23 €
52364	357	2,86 €
52365	357	2,46 €
52368	357	1,14 €
52369	357	1,19 €
52370	357	1,17 €
52373	93	252,00 €
52375	137	38,00 €

REF.	PAGE	PRICE
52378	163	10,00 €
52381	157	20,50 €
52382	331, 344	19,50 €
52384	132	29,00 €
52385	186	251,00 €
52386	186	23,60 €
52390	187	35,20 €
52391	311	5,00 €
52412	59	5,00 €
52414	141	19,00 €
52415	141	19,00 €
52416	203	14,00 €
52417	203	28,00 €
52418	21	179,00 €
52419	89	80,00 €
52420	89	108,00 €
52421	89	172,00 €
52422	213	24,70 €
52424	47	64,00 €
52425	63	33,30 €
52426	63	52,00 €
52427	63	64,00 €
52428	305	40,00 €
52430	376	10,90 €
52432	224	35,00 €
52433	69	4,80 €
52434	197	125,00 €
52439	331	227,00 €
52450	338	105,00 €
52451	43	42,00 €
52452	310	8,00 €
52453	310	21,00 €
52454	238	12,90 €
52455	198	16,00 €
52456	137	36,00 €
52460	63	16,60 €
52461	63	25,70 €
52462	68	25,30 €
52463	67	26,10 €
52464	67	42,00 €
52466	98	11,00 €
52468	62	5,90 €
52472	62	4,90 €
52473	62	9,90 €
52474	187	68,00 €
52475	187	62,00 €
52476	187	50,00 €
52477	187	70,00 €
52478	187	49,00 €
52479	187	24,70 €
52480	187	44,00 €
52481	187	52,00 €
52482	187	44,00 €
52483	187	41,00 €
52484	187	66,00 €
52485	187	51,00 €
52486	187	62,00 €

REF.	PAGE	PRICE
52487	187	63,00 €
52488	211	28,00 €
52489	210	58,00 €
52490	156	6,65 €
52491	156	10,50 €
52493	378	4,50 €
52494	241	227,00 €
52495	216	14,50 €
52497	192	26,80 €
52498	308	58,00 €
52500	54	19,00 €
52502	187	31,40 €
52503	187	32,50 €
52504	187	27,60 €
52505	187	20,80 €
52506	187	16,00 €
52507	187	30,10 €
52508	59	38,40 €
52509	59	36,20 €
52511	187	42,00 €
52512	187	50,00 €
52514	320	84,00 €
52515	70, 216	9,10 €
52516	98	28,00 €
52517	98	6,00 €
52518	201	115,00 €
52519	36, 345	25,50 €
52524	53	51,00 €
52525	53	13,80 €
52526	53	28,40 €
52527	151	82,00 €
52528	155	49,00 €
52530	361	14,00 €
52533	161, 182	10,00 €
52534	361	15,00 €
52535	361	16,50 €
52536	130	57,00 €
52538	31	62,00 €
52539	31	59,00 €
52540	159, 182	221,00 €
52541	222	45,00 €
52542	99	109,00 €
52543	160	182,00 €
52544	175	93,00 €
52545	175	177,00 €
52546	171	39,60 €
52547	168	96,00 €
52550	30	92,00 €
52551	242	151,00 €
52552	372	128,00 €
52555	134	2,38 €
52558	134	2,38 €
52565	63	11,50 €
52566	140	28,00 €
52567	140	29,00 €
52568	141	28,00 €
52569	141	28,00 €

REF.	PAGE	PRICE
52570	375	2,60 €
52571	375	2,60 €
52572	375	2,60 €
52573	375	2,60 €
52574	152	69,00 €
52575	68, 160	119,00 €
52583	69	8,50 €
52587	50	39,90 €
52588	50	45,00 €
52591	214	12,00 €
52592	214	22,00 €
52593	214	34,00 €
52595	68	64,00 €
52596	67	114,00 €
52597	67	146,00 €
52598	121, 340	1.080,00 €
52599	210	230,00 €
52600	342	884,00 €
52601	304	397,00 €
52603	28	74,00 €
52604	28	78,00 €
52605	28	76,00 €
52606	28	88,00 €
52607	203	49,00 €
52608	203	44,00 €
52609	68	29,00 €
52615	201	112,00 €
52616	296	44,00 €
52617	204	7,00 €
52618	365	29,00 €
52619	59	23,10 €
52620	31	8,80 €
52621	232	11,00 €
52624	241	28,00 €
52625	60, 198	9,00 €
52626	238	46,00 €
52627	238	120,00 €
52628	308	26,50 €
52629	208	99,00 €
52633	359	1,00 €
52634	91	5,25 €
52635	91	4,80 €
52636	194	114,00 €
52637	229	48,00 €
52638	69	9,95 €
52639	209	123,00 €
52640	225	52,00 €
52641	225	55,00 €
52642	228	32,00 €
52643	339	596,00 €
52644	360	8,80 €
52645	371	0,55 €
52646	371	0,50 €
52648	158	9,00 €
52649	370	5,00 €
52650	370	5,00 €
52652	369	2,80 €

REF.	PAGE	PRICE
52653	369	3,00 €
52655	371	39,70 €
52656	371	39,50 €
52657	371	37,50 €
52658	371	39,70 €
52659	371	39,70 €
52660	372	126,00 €
52662	370	36,50 €
52663	370	30,00 €
52664	372	168,00 €
52665	368	0,37 €
52666	368	0,36 €
52667	368	0,76 €
52668	368	1,49 €
52669	368	2,22 €
52670	368	2,95 €
52671	368	3,70 €
52672	368	4,45 €
52673	370	18,00 €
52675	154	84,00 €
52676	154	98,00 €
52677	202	17,00 €
52678	202	18,00 €
52685	210	88,00 €
52687	218	168,00 €
52690	215	54,00 €
52691	232	54,00 €
52692	324	129,00 €
52693	213	24,50 €
52694	168	49,00 €
52696	213	12,00 €
52697	213	16,00 €
52699	228	22,00 €
52700	70	20,50 €
52703	384	22,00 €
52711	383	27,50 €
52714	33	15,70 €
52715	33	10,00 €
52716	33	15,90 €
52717	33	11,00 €
52718	152	48,00 €
52719	389	0,19 €
52722	22	87,00 €
52724	151	381,00 €
52725	151	349,00 €
52727	239	34,60 €
52728	239	68,00 €
52729	239	128,00 €
52730	239	288,00 €
52731	239	38,00 €
52732	239	58,00 €
52733	239	98,00 €
52734	213	51,00 €
52735	166	4,85 €
52736	166	5,35 €
52737	166	5,50 €
52738	375	5,00 €

REF.	PAGE	PRICE
52739	375	5,00 €
52740	184	690,00 €
52749	189	79,00 €
52753	30	107,00 €
52754	204	54,00 €
52757	209	16,00 €
52758	154	88,00 €
52760	70, 216	4,10 €
52761	61	8,00 €
52762	61	9,00 €
52765	185	21,70 €
52768	356	13,80 €
52769	356	14,50 €
52770	356	23,00 €
52771	356	23,40 €
52772	356	13,90 €
52773	356	14,60 €
52774	356	14,80 €
52775	356	15,20 €
52776	356	13,80 €
52777	356	15,50 €
52778	356	14,60 €
52779	356	17,10 €
52780	356	13,90 €
52781	356	14,60 €
52782	356	14,80 €
52783	356	15,20 €
52786	64	14,60 €
52787	157	9,00 €
52788	181	39,00 €
52789	308	15,20 €
52791	58, 59	18,00 €
52794	69	28,00 €
52795	354	5,80 €
52796	228	98,00 €
52797	305	198,00 €
52798	156	18,00 €
52801	212	26,00 €
52802	226	54,00 €
52804	309	343,00 €
52805	309	426,00 €
52806	309	742,00 €
52807	309	1.714,00 €
52809	201	8,50 €
52810	170	9,00 €
52811	170	9,90 €
52812	59	65,00 €
52813	212	79,00 €
52814	149	528,00 €
52815	208	110,00 €
52816	232	28,10 €
52817	232	23,50 €
52819	216	22,00 €
52821	212	28,80 €
52822	230	32,00 €
52823	226	124,00 €
52827	138	46,00 €

REF.	PAGE	PRICE
52828	138	43,00 €
52829	222	19,00 €
52830	64	24,00 €
52831	64	18,00 €
52832	215	75,00 €
52833	237	39,30 €
52834	224	195,00 €
52835	224	272,00 €
52836	184	1.100,00 €
52838	142	56,00 €
52839	142	64,00 €
52842	372	11,00 €
52843	139	31,60 €
52845	323	170,00 €
52846	57	37,80 €
52847	57	41,00 €
52849	230	8,50 €
52850	215	7,80 €
52851	181, 395	9,65 €
52852	230	6,80 €
52858	206	298,00 €
52862	357	1,15 €
52864	357	1,20 €
52865	357	0,50 €
52866	357	0,25 €
52869	100	52,00 €
52870	100	100,00 €
52871	100	258,00 €
52873	69	11,00 €
52874	225	82,00 €
52875	225	79,00 €
52876	180	182,00 €
52877	64	15,80 €
52878	64	11,20 €
52879	64	10,10 €
52880	47	42,00 €
52881	47	17,00 €
52882	213	14,00 €
52884	329	73,00 €
52885	64	18,00 €
52886	396	18,00 €
52887	396	22,00 €
52888	400	24,00 €
52889	398	19,00 €
52890	399	22,00 €
52891	398	28,00 €
52892	399	22,00 €
52893	400	26,00 €
52894	398	22,00 €
52895	400	22,00 €
52896	396	26,00 €
52897	399	38,00 €
52898	399	36,00 €
52899	397	34,00 €
52900	397	34,00 €
52901	397	34,00 €
52902	342	970,00 €

REF.	PAGE	PRICE
52903	342	1.100,00 €
52904	69	61,00 €
52905	70	28,00 €
52906	196	38,00 €
52908	34	17,00 €
52909	34	12,50 €
52910	138	39,00 €
52912	45, 87	91,00 €
52913	51	292,00 €
52914	177	223,00 €
52915	177	199,00 €
52916	177	218,00 €
52917	177	122,00 €
52918	177	146,00 €
52919	177	181,00 €
52920	177	155,00 €
52921	177	117,00 €
52922	177	180,00 €
52923	177	59,00 €
52924	177	52,00 €
52925	177	176,00 €
52926	177	201,00 €
52927	177	59,00 €
52928	177	172,00 €
52929	177	185,00 €
52930	178	117,00 €
52931	178	45,00 €
52932	178	45,00 €
52933	178	194,00 €
52934	178	102,00 €
52935	178	94,00 €
52936	178	199,00 €
52937	178	265,00 €
52938	178	199,00 €
52939	178	28,00 €
52940	178	235,00 €
52941	178	70,00 €
52942	178	105,00 €
52943	178	75,00 €
52944	178	110,00 €
52945	178	281,00 €
52952	331, 344	74,00 €
52953	152	38,00 €
52955	61	19,80 €
52956	61	19,60 €
52957	61	23,80 €
52958	61	28,20 €
52959	61	42,00 €
52960	61	46,00 €
52962	226	42,00 €
52963	217	49,00 €
52964	56	9,45 €
52965	56	9,20 €
52966	56	9,45 €
52967	56	9,40 €
52969	172	20,70 €
52973	42	59,00 €

REF.	PAGE	PRICE
52977	182	137,00 €
52980	335	480,00 €
52982	60, 186	53,00 €
52985	322	598,00 €
52987	132	20,00 €
52991	311	10,50 €
52992	311	18,00 €
52998	185	48,00 €
52999	321	178,00 €
53001	217	242,00 €
53007	357	0,42 €
53008	201	15,50 €
53009	209	42,00 €
53010	54	18,00 €
53017	38	57,00 €
53018	40	119,00 €
53025	69	3,50 €
53026	69	5,80 €
53027	69	9,00 €
53028	331	5,80 €
53029	331	6,80 €
53030	331	12,00 €
53031	100	59,00 €
53032	100	126,00 €
53033	364	21,50 €
53037	371	0,50 €
53038	371	0,50 €
53039	371	0,50 €
53040	371	0,50 €
53041	235	37,60 €
53042	69	9,90 €
53043	175	53,00 €
53044	175	121,00 €
53045	140	35,00 €
53046	140	39,00 €
53047	141	330,00 €
53048	141	89,00 €
53049	140	89,00 €
53051	141	158,00 €
53052	140	158,00 €
53053	215	12,00 €
53054	238	6,00 €
53055	236	33,00 €
53056	241	127,00 €
53057	217	149,00 €
53058	241	193,00 €
53059	242	52,00 €
53060	170	34,90 €
53062	240	99,00 €
53063	162	36,70 €
53064	162	37,40 €
53065	162	36,90 €
53066	162	61,00 €
53067	162	61,00 €
53068	162	63,00 €
53069	208	98,00 €
53070	48	16,20 €

REF.	PAGE	PRICE
53071	48	26,10 €
53072	48	31,60 €
53073	48	50,00 €
53074	17	78,00 €
53077	174	62,00 €
53078	310	18,00 €
53079	189	89,00 €
53080	189	99,00 €
53081	52	115,00 €
53082	52	148,00 €
53083	65	64,00 €
53084	34	24,00 €
53085	135	30,00 €
53086	238	9,00 €
53087	356	11,20 €
53088	356	11,50 €
53089	356	11,50 €
53090	356	11,50 €
53091	356	10,20 €
53092	356	10,20 €
53093	356	10,20 €
53094	356	10,20 €
53095	66	20,50 €
53096	209	28,80 €
53108	22	92,00 €
53110	181, 395	27,30 €
53111	332	19,00 €
53112	314	298,00 €
53118	230	231,00 €
53119	213	52,00 €
53120	65	6,00 €
53121	65	7,35 €
53122	65	9,50 €
53124	188	287,00 €
53125	188	477,00 €
53126	189	243,00 €
53127	34	12,00 €
53129	216	84,00 €
53134	189	144,00 €
53137	155	38,00 €
53140	152	98,00 €
53141	155	68,00 €
53144	307	18,00 €
53145	332	39,20 €
53146	239	30,50 €
53147	163	41,00 €
53150	369	24,00 €
53151	143	14,00 €
53154	36, 345	462,00 €
53156	32	26,20 €
53159	25	289,00 €
53162	332	60,00 €
53164	36, 345	16,50 €
53165	36, 345	19,60 €
53166	339	10,50 €
53167	339	12,50 €
53168	339	19,00 €

REF.	PAGE	PRICE
53177	356	11,90 €
53178	356	12,20 €
53179	356	12,20 €
53180	356	12,20 €
53181	356	11,90 €
53182	356	12,20 €
53183	356	12,70 €
53184	356	12,20 €
53185	355	13,20 €
53186	355	13,20 €
53187	311	39,00 €
53188	311	7,00 €
53189	337	128,00 €
53190	337	98,00 €
53191	98	14,80 €
53192	98	52,00 €
53196	192	33,00 €
53197	174	46,00 €
53198	311	9,50 €
53200	318	69,00 €
53202	160	15,70 €
53203	357	0,46 €
53204	160	81,00 €
53205	157	19,00 €
53206	202	38,20 €
53207	225	118,00 €
53208	225	126,00 €
53209	329	8,50 €
53210	48	48,00 €
53211	99	75,00 €
53212	16	174,00 €
53214	309	285,00 €
53215	307	19,00 €
53216	130	49,00 €
53217	132	47,00 €
53218	318	26,00 €
53220	334	260,00 €
53221	365	4,75 €
53224	180	142,00 €
53225	56	3,50 €
53226	192	14,90 €
53227	135	28,00 €
53229	388	38,70 €
53230	183	19,70 €
53232	185	39,00 €
53235	203	10,40 €
53236	203	11,50 €
53237	203	12,90 €
53238	203	18,40 €
53240	234	58,00 €
53241	361	9,00 €
53246	324	1.144,00 €
53249	231	192,00 €
53250	208	85,00 €
53251	213	88,00 €
53253	96	98,00 €
53256	368	34,00 €

REF.	PAGE	PRICE
53259	249	97,00 €
53260	249	168,00 €
53261	249	214,00 €
53262	250	251,00 €
53263	250	57,00 €
53264	250	143,00 €
53265	251	195,00 €
53266	251	224,00 €
53267	251	277,00 €
53268	258	92,00 €
53269	252	50,00 €
53270	270	70,00 €
53271	270	227,00 €
53272	271	195,00 €
53273	271	75,00 €
53274	284	30,50 €
53275	284	35,50 €
53276	285	160,00 €
53277	285	45,00 €
53278	285	143,00 €
53279	286	97,00 €
53280	286	112,00 €
53281	286	55,00 €
53282	287	48,00 €
53283	287	92,00 €
53284	287	306,00 €
53285	288	56,00 €
53286	288	87,00 €
53287	288	245,00 €
53288	289	72,00 €
53289	274	45,00 €
53290	274	51,00 €
53291	274	68,00 €
53292	275	116,00 €
53293	261	134,00 €
53294	261	119,00 €
53295	262	77,00 €
53296	262	60,00 €
53297	267	45,00 €
53298	267	91,00 €
53299	278	291,00 €
53300	278	41,00 €
53301	278	44,00 €
53302	279	44,00 €
53303	244	89,00 €
53304	244	279,00 €
53305	279	136,00 €
53306	244	53,00 €
53307	279	38,50 €
53308	245	55,00 €
53309	245	285,00 €
53310	245	498,00 €
53311	275	97,00 €
53312	246	127,00 €
53313	258	139,00 €
53314	258	98,00 €
53315	295	285,00 €

REF.	PAGE	PRICE
53316	280	34,00 €
53317	280	34,00 €
53318	261	24,00 €
53319	246	18,00 €
53320	289	12,00 €
53321	289	10,50 €
53324	264	12,50 €
53325	289	7,50 €
53326	290	16,00 €
53327	290	11,00 €
53328	226	76,00 €
53330	212	38,00 €
53331	67	31,80 €
53332	67	34,50 €
53339	70	9,50 €
53340	388	86,00 €
53343	149	285,00 €
53346	50	18,00 €
53347	205	100,00 €
53348	382	14,00 €
53349	392	14,00 €
53350	382	14,00 €
53351	384	12,50 €
53352	390	12,00 €
53353	387	18,00 €
53354	384	14,00 €
53355	393	11,50 €
53356	393	11,50 €
53357	394	7,00 €
53358	390	11,50 €
53359	390	16,00 €
53360	384	18,00 €
53361	384	24,00 €
53362	385	14,00 €
53363	382	34,00 €
53364	382	16,00 €
53365	385	14,00 €
53366	385	14,00 €
53367	393	9,50 €
53368	393	9,00 €
53369	385	14,00 €
53370	393	26,00 €
53371	383	29,00 €
53372	383	26,00 €
53373	383	14,50 €
53374	392	10,00 €
53376	392	10,50 €
53377	386	20,00 €
53378	390	13,00 €
53380	393	11,50 €
53381	390	14,50 €
53382	383	11,00 €
53383	383	11,50 €
53384	225	165,00 €
53385	61, 394	19,30 €
53388	233	90,00 €
53389	57	31,50 €

REF.	PAGE	PRICE
53390	58	34,50 €
53391	234	86,00 €
53393	234	118,00 €
53394	223	598,00 €
53395	218	16,00 €
53396	58	18,30 €
53399	92	3,50 €
53400	92	5,70 €
53401	92	7,40 €
53402	92	9,60 €
53403	92	6,50 €
53404	92	6,50 €
53405	92	5,30 €
53406	92	8,55 €
53407	92	12,70 €
53408	92	19,30 €
53409	92	9,00 €
53410	217	92,00 €
53411	60	5,00 €
53412	60	4,00 €
53414	333	49,00 €
53415	333	188,00 €
53416	158	14,10 €
53417	158	26,30 €
53418	158	16,90 €
53419	372	9,70 €
53420	44	72,00 €
53421	315	298,00 €
53422	314	368,00 €
53423	323	199,00 €
53426	217	39,80 €
53427	134	5,00 €
53428	139	18,00 €
53429	139	18,00 €
53430	178	286,00 €
53434	392	18,00 €
53441	201	9,80 €
53444	27	195,00 €
53445	60	17,10 €
53449	158	16,40 €
53450	158	28,30 €
53452	280	26,50 €
53453	218	7,00 €
53456	220	98,00 €
53459	221	66,00 €
53463	242	98,00 €
53464	209, 387	153,00 €
53468	52	8,50 €
53470	171	176,00 €
53472	204	12,00 €
53473	204	36,00 €
53474	234	94,00 €
53477	217	36,10 €
53478	52	4,55 €
53479	52	6,40 €
53480	52	19,90 €
53481	52	27,40 €

REF.	PAGE	PRICE
53484	332	615,00 €
53485	205	140,00 €
53486	183	29,30 €
53487	59	16,70 €
53488	229	61,00 €
53489	211	68,00 €
53490	209	275,00 €
53492	163, 410	380,00 €
53499	220	29,00 €
53500	220	29,00 €
53501	209	24,00 €
53502	236	38,70 €
53503	338	12,00 €
53504	410	38,00 €
53505	135	77,00 €
53506	135	36,00 €
53507	354	27,00 €
53508	365	14,00 €
53517	64	9,50 €
53518	310	3,50 €
53519	130	42,00 €
53520	146	228,00 €
53522	209	24,00 €
53523	275	91,00 €
53524	237	51,00 €
53525	182	12,00 €
53526	338, 348	119,00 €
53531	169	109,00 €
53532	164, 348	119,00 €
53533	409	1,50 €
53536	143	34,00 €
53537	204	14,50 €
53538	204	14,50 €
53539	219	66,00 €
53541	152	168,00 €
53542	159, 372	980,00 €
53543	337	13,80 €
53545	180	35,70 €
53547	56	14,70 €
53548	56	15,60 €
53549	56	14,30 €
53550	56	14,70 €
53551	374	16,00 €
53552	374	16,00 €
53553	374	16,00 €
53561	365	28,00 €
53565	24	258,00 €
53566	304	32,00 €
53567	161	43,00 €
53568	133	12,00 €
53569	133	18,00 €
53570	136	154,00 €
53572	161	348,00 €
53573	151	36,00 €
53574	31	47,00 €
53575	55	16,00 €
53576	153	189,00 €

REF.	PAGE	PRICE
53581	164, 348	119,00 €
53582	164, 348	174,00 €
53583	164, 348	174,00 €
53584	338, 348	119,00 €
53585	338, 348	168,00 €
53586	338, 348	168,00 €
53587	173	44,00 €
53588	146	178,00 €
53589	70	12,00 €
53590	321	1.190,00 €
53591	64	5,50 €
53592	312	25,00 €
53593	160	41,00 €
53594	163	54,00 €
53595	163	61,00 €
53596	376	3,65 €
53597	376	3,70 €
53598	376	3,95 €
53599	221, 389	30,30 €
53602	61	30,50 €
53603	61	45,00 €
53604	61	118,00 €
53605	372	141,00 €
53606	158	55,00 €
53608	148	98,00 €
53609	302	182,50 €
53610	302	294,00 €
53611	156	27,50 €
53612	310	96,00 €
53613	68	19,50 €
53614	68	21,50 €
53615	68	34,60 €
53616	68	10,40 €
53617	68	9,25 €
53618	68	13,90 €
53620	89	88,00 €
53621	355	2,50 €
53622	355	2,50 €
53623	355	2,50 €
53624	355	2,50 €
53625	160	68,00 €
53626	154, 184	18,00 €
53627	305	22,50 €
53629	164	14,30 €
53630	164	18,80 €
53631	164	33,50 €
53632	164	46,00 €
53633	164	46,00 €
53634	164	63,00 €
53635	225	85,00 €
53636	354	22,00 €
53637	215	85,00 €
53638	222	243,00 €
53639	47	28,60 €
53640	47	34,40 €
53641	47	41,00 €
53642	47	54,00 €

REF.	PAGE	PRICE
53643	47	92,00 €
53644	303	1.238,00 €
53645	303	268,00 €
53646	153	69,00 €
53648	290	107,00 €
53649	291	89,00 €
53650	212	47,00 €
53651	280	91,00 €
53652	237	53,00 €
53653	264	207,00 €
53654	47	81,00 €
53655	182	12,00 €
53656	334	198,00 €
53657	334	248,00 €
53658	334	99,00 €
53659	334	121,00 €
53660	334	146,00 €
53661	77	790,00 €
53662	214	89,00 €
53663	235	8,00 €
53664	238	38,00 €
53665	238	19,00 €
53666	238	28,00 €
53667	35	32,00 €
53668	35	34,00 €
53669	215	45,00 €
53670	202	29,50 €
53671	51, 89	41,00 €
53672	82	440,00 €
53673	183	80,00 €
53674	94	447,00 €
53675	186	50,00 €
53676	186	44,00 €
53677	186	55,00 €
53678	186	52,00 €
53681	149	743,00 €
53682	322	98,00 €
53683	196	116,00 €
53684	321	1.880,00 €
53685	189	310,00 €
53686	77	790,00 €
53687	328	298,00 €
53688	328	495,00 €
53689	147	238,00 €
53690	137	34,00 €
53691	137	36,00 €
53693	360	521,00 €
53694	54	18,40 €
53695	360	504,00 €
53696	209	22,00 €
53697	302	398,00 €
53698	360	717,00 €
53701	240	188,00 €
53702	97	28,50 €
53703	97	41,00 €
53704	97	42,00 €
53705	191	80,00 €

REF.	PAGE	PRICE
53706	291	98,00 €
53707	136	153,00 €
53708	74, 76, 77, 83	325,00 €
53710	404	16,00 €
53711	404	16,00 €
53712	403	16,00 €
53713	403	16,00 €
53714	403	16,00 €
53715	402	19,00 €
53716	402	19,00 €
53717	402	19,00 €
53718	401	19,00 €
53719	401	19,00 €
53720	401	19,00 €
53721	355	18,80 €
53724	332	46,00 €
53725	314	248,00 €
53726	148	128,00 €
53727	23	198,00 €
53728	23	198,00 €
53729	184	19,10 €
53733	147	238,00 €
53734	130	23,70 €
53735	203	44,00 €
53736	189	98,00 €
53737	45	12,50 €
53738	45	10,90 €
53739	45	10,50 €
53740	45	9,10 €
53741	204	14,00 €
53742	223	1.325,00 €
53743	32, 175	39,70 €
53744	170	63,00 €
53745	362	6,40 €
53746	362	6,40 €
53747	362	6,40 €
53748	362	6,60 €
53749	362	6,70 €
53750	362	6,70 €
53751	362	6,80 €
53752	362	6,95 €
53753	362	7,10 €
53754	362	7,40 €
53755	362	7,50 €
53756	362	7,90 €
53757	362	7,90 €
53758	362	8,20 €
53759	362	8,50 €
53760	362	9,60 €
53761	77	490,00 €
53762	77	490,00 €
53767	77	790,00 €
53768	77	490,00 €
53769	80, 297, 300	178,00 €
53770	80, 298, 300	198,00 €
53771	80, 299, 300	158,00 €

REF.	PAGE	PRICE
53772	80, 299, 300	229,00 €
53773	80, 297, 300	298,00 €
53774	80, 298, 300	190,00 €
53775	80, 300	1.109,00 €
53776	131	19,10 €
53778	354	4,50 €
53779	318	36,00 €
53780	132	14,50 €
53781	377	18,00 €
53782	96	14,00 €
53784	150	148,00 €
53785	376	4,80 €
53786	380	98,00 €
53791	378	4,80 €
53794	376	28,00 €
53796	380	76,00 €
53797	377	0,10 €
53802	380	120,00 €
53806	380	250,00 €
53808	379	16,50 €
53809	379	8,00 €
53811	379	8,90 €
53826	378	16,00 €
53827	378	32,00 €
53832	378	1,81 €
53838	380	38,00 €
53839	379	0,25 €
53845	318	64,00 €
53849	312	16,10 €
53850	123	14,90 €
53851	125	88,00 €
53852	125	207,00 €
53853	125	14,40 €
53854	125	27,00 €
53855	125	24,80 €
53856	125	62,00 €
53857	126	27,00 €
53858	126	28,80 €
53859	124	67,00 €
53860	124	3,65 €
53861	124	5,45 €
53862	377	6,00 €
53863	377	3,00 €
53864	369	138,00 €
53867	82	1.095,00 €
53868	74	1.090,00 €
53869	75	990,00 €
53870	75	990,00 €
53872	348	118,00 €
53873	307	285,00 €
53874	307	398,00 €
53875	216	134,00 €
53876	259	64,00 €
53877	411	430,50 €
53878	411	574,00 €
53879	411	838,50 €

REF.	PAGE	PRICE
53880	320	598,00 €
53881	164, 348	79,00 €
53882	164, 348	79,00 €
53883	50	18,40 €
53884	50	30,20 €
53885	50	35,70 €
53886	50	20,30 €
53887	50	30,30 €
53888	50	37,90 €
53895	317	107,00 €
53896	317	127,00 €
53897	317	140,00 €
53898	317	148,00 €
53902	378	25,00 €
53903	97	59,00 €
53904	77	790,00 €
53905	56	7,30 €
53906	56	8,65 €
53908	56	7,25 €
53909	56	9,70 €
53910	392	19,00 €
53911	57	8,80 €
53912	75	1.280,00 €
53913	75	1.280,00 €
53914	379, 412	75,00 €
53915	22	65,00 €
53917	54	9,00 €
53919	363	81,00 €
53921	190	39,00 €
53922	190	29,00 €
53927	329	66,00 €
53928	26	278,00 €
53929	329	95,00 €
53932	61	8,00 €
53939	74	1.280,00 €
53940	79, 344, 346, 379	13,20 €
53942	79, 344, 346, 379	0,50 €
53943	54, 86	21,50 €
53944	54, 86	19,50 €
53945	54, 86	18,90 €
53946	377	0,83 €
53947	336	145,00 €
53948	336	324,00 €
53949	409	4,50 €
53950	409	4,50 €
53951	80, 300	1.794,00 €
53952	80, 300	1.794,00 €
53953	20	29,00 €
53954	45	8,50 €
53955	45	10,00 €
53956	408	353,00 €
53957	377	0,26 €
53958	98	6,50 €
53964	364	9,65 €
53965	364	25,80 €
53967	57	10,20 €

REF.	PAGE	PRICE
53968	314	49,00 €
53969	323	96,00 €
53970	343	3.790,00 €
53972	52	550,00 €
53973	408	284,00 €
53974	134	38,00 €
53976	61	9,00 €
53977	332	17,50 €
53978	195	38,90 €
53979	45, 88	34,60 €
53980	45, 88	34,60 €
53981	333	143,00 €
53982	333	219,00 €
53983	188	215,00 €
53984	374	8,00 €
53985	374	8,00 €
53986	374	8,00 €
53987	344, 379	9,50 €
53988	173	101,00 €
53992	392	18,00 €
53993	66	77,00 €
53997	211	48,00 €
53999	127	2,00 €
54000	127	2,50 €
54001	317	285,00 €
54002	127	3,00 €
54003	238	104,00 €
54004	133	16,00 €
54005	46	14,00 €
54006	77	490,00 €
54008	127	3,50 €
54010	127	4,50 €
54011	127	5,00 €
54013	369	35,00 €
54015	57	10,20 €
54016	211	76,00 €
54017	182	12,00 €
54018	49	9,85 €
54019	49	17,90 €
54021	49	13,50 €
54022	49	9,95 €
54023	49	13,50 €
54024	49	17,90 €
54028	49	28,00 €
54029	49	28,00 €
54030	49	18,80 €
54031	49	19,30 €
54032	39, 88	84,00 €
54033	161	49,00 €
54034	9	178,00 €
54035	12	149,00 €
54036	13	99,00 €
54037	14	88,00 €
54038	15	88,00 €
54039	135	154,00 €
54040	330	240,00 €
54041	40	198,00 €

REF.	PAGE	PRICE
54042	358	13,00 €
54043	408	48,00 €
54044	143	99,00 €
54045	9	179,00 €
54046	12	150,00 €
54047	13	100,00 €
54048	14	89,00 €
54049	15	89,00 €
54050	306	895,00 €
54051	308	39,00 €
54053	342	248,00 €
54054	342	268,00 €
54055	342	220,00 €
54056	342	260,00 €
54057	342	248,00 €
54058	342	348,00 €
54059	343	428,00 €
54060	55	6,00 €
54061	55	6,00 €
54066	39, 87	83,00 €
54068	200	120,00 €
54069	221	29,50 €
54070	55	18,00 €
54071	55	26,50 €
54072	358	38,50 €
54073	363	70,00 €
54074	363	18,50 €
54076	409	9,00 €
54078	144	68,00 €
54079	41	83,00 €
54080	96	53,50 €
54081	43	28,00 €
54082	11	189,00 €
54083	49	9,75 €
54084	49	13,10 €
54085	49	17,80 €
54086	49	9,25 €
54087	49	17,30 €
54088	135	132,00 €
54089	65	17,50 €
54090	21	56,00 €
54091	35, 345	441,00 €
54092	291	24,00 €
54093	35, 79, 87, 345, 346	441,00 €
54097	41	38,90 €
54098	47	158,50 €
54099	66	13,80 €
54100	302	265,00 €
54101	38	61,00 €
54105	21	33,00 €
54106	17, 46	89,00 €
54108	18	66,00 €
54109	20	34,00 €
54110	40	46,00 €
54111	333	4,75 €
54112	62	18,00 €
54113	333	7,65 €

REF.	PAGE	PRICE
54114	79, 330, 346	248,00 €
54115	43	26,80 €
54116	18	66,00 €
54117	38	74,00 €
54119	44	78,00 €
54120	41	59,00 €
54122	131	38,00 €
54123	131	40,00 €
54124	131	47,00 €
54125	337	152,00 €
54126	54	39,00 €
54129	79, 346	110,00 €
54130	79, 345, 346	58,00 €
54131	345	58,00 €
54132	79, 346	190,00 €
54133	135	547,00 €
54134	78, 84	1.415,00 €
54135	197	82,00 €
54136	372	107,00 €
54137	315	288,00 €
54139	218	147,00 €
54140	17	36,00 €
54141	22	42,00 €
54142	62	15,20 €
54143	318	249,00 €
54144	318	298,00 €
54145	318	377,00 €
54146	318	492,00 €
54147	318	198,00 €
54149	42	60,00 €
54150	42	23,50 €
54151	374	9,00 €
54152	374	9,00 €
54153	374	9,00 €
54154	29	37,50 €
54155	374	8,00 €
54156	374	8,00 €
54157	374	8,00 €
54158	86	38,00 €
54159	43	47,00 €
54160L	143	17,50 €
54160R	143	17,50 €
54161	142	90,00 €
54162	142	81,00 €
54163	142	80,00 €
54164	29	34,00 €
54166	363	32,40 €
54168	20	49,00 €
54169	363	13,80 €
54170	363	16,50 €
54172	137	81,00 €
54173	137	87,00 €
54174	41	139,00 €
54175	326	34,00 €
54176	350	188,00 €
54177	374	16,00 €

REF.	PAGE	PRICE
54178	374	16,00 €
54179	374	16,00 €
54181	310	25,10 €
54182	310	34,70 €
54183	310	38,20 €
54184	310	44,00 €
54186	206	250,00 €
54187	46	39,30 €
54188	376	19,00 €
54189	376	19,00 €
54190	376	19,00 €
54191	376	19,00 €
54192	375	8,90 €
54193	375	8,90 €
54194	375	8,90 €
54195	375	8,90 €
54198	372	59,00 €
54199	292	94,00 €
54200	296	56,00 €
54201	264	37,60 €
54202	246	68,00 €
54203	247	91,00 €
54204	265	124,00 €
54205	281	49,00 €
54206	252	113,00 €
54207	270	38,90 €
54208	265	76,00 €
54209	265	29,70 €
54210	276	84,00 €
54211	247	74,00 €
54212	247	39,40 €
54213	260	19,80 €
54214	281	96,00 €
54215	248	57,00 €
54216	248	49,00 €
54217	281	104,00 €
54218	292	142,00 €
54219	253	60,00 €
54220	208	197,00 €
54221	282	111,00 €
54222	253	59,00 €
54223	266	149,00 €
54224	266	64,50 €
54225	276	133,00 €
54226	295	71,00 €
54227	253	122,00 €
54228	254	187,00 €
54229	337	48,00 €
54230	337	68,00 €
54231	337	138,00 €
54232	337	248,00 €
54233	79, 346	1.856,00 €
54234	79, 346	1.856,00 €
54235	79, 346	1.856,00 €
54236	79, 346	1.856,00 €
54237	78	1.887,00 €
54238	78	1.887,00 €

REF.	PAGE	PRICE
54239	78	1.887,00 €
54240	78	1.887,00 €
54241	79, 346	120,00 €
54246	182	104,00 €
54247	182	99,00 €
54248	158	58,00 €
54249	158	103,00 €
54250	10	188,00 €
54251	157	43,00 €
54252	340	199,00 €
54253	227	166,00 €
54254	62	43,00 €
54255	156, 312	68,00 €
54256	330	48,00 €
54257	319	318,00 €
54258	19	58,00 €
54260	266	277,00 €
54261	24	321,00 €
54262	323	88,00 €
54263	323	130,00 €
54264	323	240,00 €
54265	343	1.290,00 €
54266	29	39,50 €
54267	133	9,50 €
54269	51	56,00 €
54270	136	42,00 €
54271	136	54,00 €
54273	214	10,10 €
54274	214	11,00 €
54275	214	13,20 €
54277	19	53,50 €
54278	409	4,50 €
54279	58	6,00 €
54280	237	156,50 €
54288	259	72,50 €
54289	277	38,00 €
54290	306	4.307,00 €
54291	220	5.054,00 €
54293	254	17,50 €
54294	374	8,00 €
54295	81	500,00 €
54296	81	520,00 €
54297	81	540,00 €
54298	354	7,50 €
54299	227	227,00 €
54302	53	11,50 €
54304	50	26,00 €
54305	351	232,50 €
54306	352	219,50 €
54308	352	89,00 €
54309	352	71,00 €
54310	352	57,00 €
54311	58	13,00 €
54312	210	191,50 €
54313	126	43,00 €
54314	126	82,00 €
54316	172	182,00 €

REF.	PAGE	PRICE
54317	226	124,00 €
54318	271	105,00 €
54321	343	898,00 €
54322	344, 379	19,00 €
54323	259	119,00 €
54324	257	11,00 €
54325	409	22,50 €
54326	79, 344, 346, 379	7,30 €
54327	72	2.788,00 €
54328	94	199,00 €
54329	371	37,50 €
54330	58	12,50 €
54331	65	27,00 €
54336	150	259,00 €
54338	39	60,00 €
54339	51	273,00 €
54340	147	296,00 €
54341	335	643,00 €
54342	335	858,00 €
54343	53	31,00 €
54344	132	10,50 €
54345	206	15,00 €
54346	127	11,50 €
54347	214	46,00 €
54348	126	291,00 €
54349	325	8,00 €
54350	325	12,50 €
54351	325	14,00 €
54352	325	18,00 €
54353	325	23,50 €
54354	325	34,50 €
54355	325	12,00 €
54356	326	19,50 €
54357	325	15,00 €
54358	325	18,50 €
54359	326	14,00 €
54360	325	14,00 €
54361	325	14,00 €
54362	326	14,00 €
54363	325	14,00 €
54364	326	14,00 €
54365	325	12,50 €
54366	326	18,50 €
54367	306	729,00 €
54368	219	2.329,00 €
54369	374	16,00 €
54370	374	16,00 €
54371	374	16,00 €
54372	198	157,00 €
54373	210	395,00 €
54374	96	75,50 €
54376	58	12,00 €
54379	131	28,00 €
54380	233	119,00 €
54381	233	5,00 €
54382	233	5,00 €
54383	233	5,00 €

REF.	PAGE	PRICE
54384	222	32,50 €
54386	324, 346	5.839,00 €
54388	93	366,00 €
54389	76	790,00 €
54390	389	199,00 €
54391	207	221,00 €
54392	207	1.855,00 €
54393	95	92,00 €
54394	95	64,00 €
54395	95	53,00 €
54396	320	2.250,00 €
54397	147	249,00 €
54398	254	41,00 €
54399	255	56,50 €
54400	255	141,00 €
54401	255	57,00 €
54402	256	201,00 €
54403	256	225,00 €
54404	256	131,00 €
54405	257	111,00 €
54406	257	73,00 €
54407	292	59,50 €
54408	293	46,00 €
54409	293	32,00 €
54410	293	33,50 €
54411	294	36,00 €
54412	294	57,00 €
54413	294	115,00 €
54414	272	97,50 €
54415	272	60,00 €
54416	272	31,00 €
54417	273	153,00 €
54418	273	37,00 €
54419	262	57,00 €
54420	263	102,00 €
54421	263	52,00 €

REF.	PAGE	PRICE
54422	267	140,00 €
54423	268	108,00 €
54424	263	64,50 €
54425	268	124,00 €
54426	268	69,00 €
54427	269	113,00 €
54428	269	31,00 €
54429	269	55,00 €
54430	248	34,00 €
54431	295	184,00 €
54432	260	43,00 €
54433	260	18,00 €
54434	282	48,50 €
54435	282	14,50 €
54436	283	124,00 €
54437	283	110,00 €
54438	277	40,00 €
54439	277	32,50 €
54479	59	36,50 €
54480	409	1,00 €
54482	334	677,00 €
54483	325	14,00 €
54484	325	26,00 €
54485	325	36,00 €
54486	325	9,50 €
54487	326	15,00 €
54488	325	15,00 €
54489	326	19,50 €
54490	326	15,00 €
54491	326	17,50 €
54492	326	19,50 €
54493	325	13,50 €
54494	325	14,00 €
54495	326	18,00 €
54496	326	16,50 €
54497	326	12,50 €

REF.	PAGE	PRICE
54498	309	6.090,00 €
54501	80, 300	1.794,00 €
54502	80, 300	1.794,00 €
54503	76	490,00 €
54534	355	24,00 €
60001	116	88,00 €
60003	116	110,00 €
60004	117	79,00 €
60005	105	132,00 €
60006	106	182,00 €
60007	111	170,00 €
60009	108	168,00 €
60010	111	170,00 €
60011	112	175,00 €
60012	122	48,00 €
60013	122	80,00 €
60015	122	138,00 €
60016	122	49,00 €
60017	122	64,00 €
60019	110	178,00 €
60020	110	175,00 €
60022	112	470,00 €
60023	106	212,00 €
60024	105	190,00 €
60025	105, 122	31,60 €
60026	105, 122	3790 €
60027	118	99,00 €
60028	109	142,00 €
60029	119	240,00 €
60030	119	112,00 €
60031	120	142,00 €
60032	113	123,00 €
60033	108	104,00 €
60035	117	30,00 €
60037	114	222,00 €
60038	113, 312	255,00 €

REF.	PAGE	PRICE
60039	118	265,00 €
60040	120	440,00 €
60041	114	77,00 €
60042	115	106,00 €
60043	115	123,00 €
60044	103	330,00 €
60044C	103	485,00 €
60045	121	298,00 €
60046	102	174,00 €
60046C	102	339,00 €
60047C	107	318,00 €
60048	104	366,00 €
60048C	104	560,00 €
60049C	109	329,00 €
70001	406	35,00 €
70002	406	35,00 €
70003	406	35,00 €
70004	406	42,00 €
70005	406	42,00 €
70006	406	42,00 €
70009	406	35,00 €
70011	406	42,00 €
70012	406	42,00 €
70013	406	44,00 €
70014	406	44,00 €
70015	406	44,00 €
70016	406	44,00 €
70017	406	44,00 €
90003	160	35,20 €
90004	160	25,80 €
JBMW-BEXP	362	24,50 €
METEXP	361, 406, 410	62,00 €
SERIE124	360	710,00 €
SERIE262	154, 184	199,00 €





www.jbmcamp.com



JBMprofessionaltools



@jbmtools



jbmtools



JBM Campllong S.L.U.



CAT2024EN



8 435034 988888